

The Miles Paper

Cliff Miles

October 2022

For additional resources and content go to TheMilesPaper.com.

You are welcome to share this document. Distribution of this paper is not limited.

Table of Contents

PART I

A New Family, Genus, and Species of Nazca Alien Is Described	1
Summary	61
History of the Discovery	67

PART II

Ben Rich	81
The Wilson Memo	85
The Secret Space Program	119
UFOs and Nukes	145
Binary Code Incident: Rendlesham Forest, England	163
Binary Code Incident: Wadley, Georgia, USA	179
Maria	189
UFO Photos	199
The Ronald Reagan Briefing	221
Alien Photos	243
Estimate of the Situation	248

Introduction

There are two forces at play in regard to extraterrestrial truth. One is the group of people who control the alien narrative, who, in the interest of national security, are working to keep the truth from ever seeing the light of day. They don't want it disclosed that we have our own flying saucers, Tic-Tac crafts, and TR-3Bs and that we have interstellar travel. Some claim that we will be too frightened to learn the truth that there are aliens—a claim which I reject.

Those in the other group are the people in-the-know, who know the truth about this issue and are making every effort to get the information and proof out in the open.

I have chosen to stay completely quiet in regard to making this paper public. No one has the slightest idea that this is coming. I understood the need for complete anonymity because of a statement made by Linda Moulton Howe in which she was informed by one of the people who is on the inside that every word she utters is known.

It's a bit humorous that a dinosaur paleontologist is going to be responsible for the disclosure of proof that people are seeking. There is no ancestor in the fossil record for the alien beings found in Nazca, Peru.

I had to design a methodology for successfully getting this project disseminated. I decided that since I could prove scientifically that aliens are real, I could also prove what these hard-working UFO researchers have been trying to tell you for decades is also real. I assembled what I consider to be the strongest material for worldwide disclosure and wrote this paper.

I have distributed more than 50 thumb drives containing the paper along with some of my other work to provide background into who I am. All I want to do in life is to make things better for as many people as I can. Creating the website TheMilesPaper.com was the final step. It has been up and running for some time now freely distributing this paper for all who want it, and you are encouraged to share it with everyone you know.

Cliff Miles

October 2022

A New Family, Genus, and Species of Nazca Alien Is Described

Clifford A. Miles, CEO, retired
Western Paleontological Laboratories, Inc.

X-rays, CT scans, and DNA studies allowed me to do the osteological description, which shows the Nazca specimens to be unique to science and not of an Earthly origin.

ABSTRACT

A new family, genus, and species of alien being is described. This new species has a single lower arm bone. Where humans have two forearm bones, the ulna and radius, they have only one. There are NO known ancestors in the fossil record that have this feature. Also there are no animals on Earth, living or made extinct by us, that have a single lower arm bone. This feature alone makes a strong case that they did not evolve on this planet, although it is not the only feature in support of extraterrestrial origin.

This is an upright bipedal species with both reptile and mammalian features in their skeletons. The body plan of these beings is similar to humans, however many obvious differences—i.e., they have no opposable thumb—do not fit our ideal model for evolutionary success. They glaringly look like typical gray alien species that have been reported over the decades.

INTRODUCTION

This description is based on 8 individuals that were discovered in Peru in late 2016. Five individuals are complete. One individual is missing only its head, and it was this individual that was used for DNA studies along with one of the two loose skulls. It was obvious during the study that neither loose skull belonged to the headless individual, because the seated skeleton has a fresh-looking break to the neck, whereas, in the two loose skulls the preservation is consistent and complete showing no signs of damage.

Robert Carroll's *Vertebrate Paleontology and Evolution*, was written as a comprehensive text for university courses in vertebrate biology. When it was written it was the seminal reference for the more than 500 million year history of vertebrate evolution recorded on this Earth. The fossil record allows us to determine the interrelationships of modern species and trace the origin of skeletal features that characterize each major group. Is our knowledge of the



The type specimen (NA-01).



fossil record complete? No, but insofar as our understanding of the major groups is concerned, nothing new has come to light for decades.

The form of an animal's skeleton determines its function. Here we have a humanoid being with the mammal-like feature of a clavicle that looks very much like our own. Its basic body plan is like ours, with a head, shoulders, trunk, arms, and legs. You can see that it was bipedal and walked upright.

These beings have a large elongated skull, large forward-facing eyes, no teeth, horizontal ribs that begin at dorsal 7, a single lower arm bone, a single lower leg bone, one bone in each wrist, and no ankle bones. The pelvic-girdle is absent. Instead they have a cloaca-like opening for the deposition of eggs. They have reptile-like skin and fingernails. The type specimen, a female, is 57.7 cm tall—just under 2 feet.

The fact that these beings are here, with flesh and bones preserved, implies that their ancestors should be in the fossil record. The fact that they are not in the fossil record implies that they did not originate on Earth. As a career paleontologist I have seen nothing in the fossil record that has the remote possibility of being an ancestor. I asked colleagues, and they agree with me.

Please Note: Throughout this description I intend to describe the remains with the respect I believe is due. I believe they were sentient beings worthy of our respect since they came from another planet. They very likely had superior intellect to our own.

The past fifty years has seen a revolution in the methodology of establishing evolutionary relationships, and scientists have proposed many new theories regarding the factors controlling the rate and direction of evolution. The use of the fossil record in determining the polarity (the direction of evolutionary change) and homology (similarity of structures) has been characterized throughout these studies. This has been critical for establishing phylogenies, (the lines of descent).

Paleontologists have a good understanding of the major transitions between amphibians and reptiles, reptiles and mammals, and dinosaurs and birds. These beings are clearly amniotes, which are tetrapod vertebrates that comprise sauropsids (including reptiles and birds) and synapsids (including

mammals). Amniotes are distinguished by a membrane (amnion) protecting the embryo and lack a larval stage. Because of this trait, amniotes lay eggs on land or retain them within the mother. Two of these beings have eggs. The type specimen clearly has three eggs. All earthly amniotes have an ulna and radius, which these beings do not.

Naturally I will be hampered in this description because we are limited to the paleontological evolution for Earth, and I do not have direct access to the specimens. I take full responsibility for my errors. On the plus side, because we are familiar with Earth's patterns of vertebrate evolution, I have confidence in this osteological description.

I do not intend to classify these beings beyond the level of a new family, genus, and species name. I intend to let the geneticists figure out where they belong in regard to their genetic origins.

I am indebted to Dr. Konstantin Korotkov who wrote the book *Mysterious Mummies of Nazca: Eyewitness Testimony* and Dr. Dmitrii V. Galetckii for his work on this new species of alien being. It was his work in part 3 of the book that I used for the basis of this paper. I also used video screen shots from Gaia, a member-supported media network for the majority of the images in the paper.

SHORT HISTORY OF THE DISCOVERY

A more extensive history begins on page 67.

In October 2016, Leandro Benigno Rivera, an archaeological explorer with 25 years of experience, and a few friends brought his finds to Cusco to visit the president of the Inkari Institute, Thierry Jamin of France.

Thierry Jamin, an archaeologist and historian, is dedicated to the study of Peruvian heritage. He had worked with Mr. Rivera off and on whenever he wanted help with identifications.

Mr. Jamin was told that the group was in possession of several little bodies, heads, and hands. They were looking for professional opinions and they wanted help in disclosing the findings. Jamin's first impression was that they were authentic, and he recognized immediately the significance of the find. Images were uploaded to the internet so it became public knowledge. Right away people from all over the world were interested in the findings.

In October/November 2016 Jamie Maussan of Mexico, an award-winning TV investigative journalist with programs such as *El Sol de Mexico* and *60 Minutes* saw the images. What he saw didn't look human. Initially he thought they were fakes. In March 2017 a biologist contacted him and urged him to talk to Thierry Jamin.

Maussan interviewed Jamin on his program on the internet, recognizing Thierry Jamin's credibility and the seriousness and importance of the find.

Maussan contacted Gaia—a member-supported media network of truth seekers—to see if they wanted to investigate the bodies with him and his team. Research teams were formed, and their work commenced. Not one governmental institution would commit to an ongoing study of the bodies.

After some backlash, a university took interest in the bodies—Universidad Nacional San Luis, De Ica, which is about 190 miles south of Lima in the Nazca region. All of the bodies went there except Josephina, which I have chosen as the Type for the species. (The specimens were given names for ease of the study.) Leandro Benigno Rivera refused to turn her over because he believes that she has great value. I agree with him and he should be compensated appropriately and forgiven since he is in a legal gray area in regard to keeping her.

After the flurry of 16 documentaries on the Gaia channel and one on YouTube and the meeting between the Gaia team and Peruvian government officials **all** research stopped. It has been nearly 6 years. WHY? The powers that are in control of hiding the alien narrative have put a stop to it. The proof is the fact that no further progress or study has been done.

Gaia team members had an idea of what they had, but they just couldn't convince the Peruvian government of what the bodies were because of the poisoned environment created by the humanoid three-fingered, three-toed enlarged-headed body named Maria. The Maria body is treated in part 2 of *The Miles Paper*.

What the Gaia team lacked, but didn't know it, was having a paleontologist on board with knowledge of the fossil record. I knew that nothing more was ever going to be done, so I chose to act and write this paper.

DNA

These beings have unique DNA. The genetic studies performed on the seated individual and one of the loose skulls does not coincide with **any** of the known living creatures on earth. I propose that Dr. William Brown be given the honor to head future research, since he was the only one in the United States to commit professionally to the initial study.

NA-05 (Nazca Alien 5) Victoria's DNA samples went to Canada, Mexico, and Russia. They were taken from the neck and hip. Dr. Konstantin said, "Of all known to us DNA, organic life, I mean human, animals, plants, bacteria, microbes, there is NO correlation with Victoria, no match at all, so is clear by scientists that it is something different. This is something amazing and never before seen" (see Gaia.com documentary *Unearthing Nazca*).

Cen4gen labs from Edmonton, Alberta, Canada, performed the sample processing and sequencing. The Canadian laboratory had a greater amount of material, so that they were able to do better sequencing. The computerized analysis of the data showed **the DNA does not coincide with any human being or living organisms. The specimens are an unknown species.**

The same conclusions were made in the Russian laboratory of V.S. Baranov.

Geneticist, Clara Ines Martinez from Colombia studied the DNA specimen that was taken from one of the two heads. She reached the same conclusion of their uniqueness.

Victoria the Victor: What I mean by this statement is that when the first DNA results were obtained it became clear that Victoria was a male because the DNA contained a Y-chromosome. For the ease of this paper I will continue to use the original name that was given.

In more than one of these individuals metal objects had been implanted. In the case of Josephina I came to the conclusion independently that hers was to stabilize her broken and healed clavicle. This implies a sophisticated knowledge of medical treatment. Is it possible that it's unique shape and structure could in some way create a resonance that aided in healing? Only further study will give us the answers.

KEY TO THE INDIVIDUALS

NA = *Nazca Alien*

NA-01 Originally called Josephina, this specimen is designated as the holotype.

NA-02 Originally called Alberto, this male will be a paratype for the species.

NA-03 Loose skull #1 One of these was a DNA donor. Paratype.

NA-04 Loose skull #2 One of these was a DNA donor. Paratype.

NA-05 Originally called Victoria. Later DNA confirmed this as a male. DNA donor. Paratype.

NA-06 Complete individual, originally part of “the family.” Paratype.

NA-07 Complete female individual, originally part of “the family.” Paratype with eggs.

NA-08 Complete individual, originally part of “the family.” Paratype.

NA-09 Complete individual? All you can see of it is part of the chest and an arm in a cave photo. It is lying next to Victoria and is obviously a juvenile.

NA-10 Loose skull that could not possibly belong to NA-005 Victoria. This skull is much too small.

NA-11 Complete individual. It has the size and look of a very young individual.

*The majority of the study was performed using Nazca aliens 01–05.

For most of this study 8 individuals were available. Late in my research I came across information

on three additional individuals—another body from the cave, a very small skull (that is too small to belong to any of the other individuals), and a very small complete individual with most of the diatomaceous earth removed.

SYSTEMATICS

Kosmosidae n. f.

Moultonus n. g.

dolani n. sp.

Family

Kosmosidae n. f.

Etymology. Greek for “Order/world.” Cosmos is originally a Greek word meaning both “order” and “world,” because the ancient Greeks thought that the world was perfectly harmonious and impeccably put in order. Today Cosmos is the sum total of everything—all of creation. I believe that this is an appropriate family name for these beings.

Genus

Moultonus n. g.

Holotype. NA-01 consisting of a complete body with all of the soft tissues preserved.

Etymology. For Linda Moulton Howe who has researched this subject for decades and maintained her convictions in the face of the onslaught from nonbelievers.



Linda Moulton Howe



Tracey and Richard Dolan

Species

dolani n. sp.

Etymology. For Richard and Tracey Dolan who continue to fight the good fight as UFO researchers.

Moultonus dolani has no monophyletic ancestor to which this species can be assigned—in other words, no ancestor in the fossil record. She is unique.

Please note: Any errors interpreting this species are my own. I used Photoshop extensively to clean up images. I used Topaz Sharpen AI and Gigapixel AI to enhance images so that I would be better able to see features that were otherwise difficult to see.

PRELIMINARY DIAGNOSIS

Cranial

The skull is anteriorly-posteriorly elongated with fused lower jaws. Teeth are absent. The absence of teeth implies weak jaw mechanics. Prementary are present, as seen in the Dinosauria. Premaxilla are fused and became a premaxillary plate. This feature appears to be jointed in the x-rays but not in the CT scans.

The most fascinating part of their skulls is that they have a prementary and premaxilla that has taken the place of the teeth and lower jaw for mastication. In the lateral views of their skulls you can see clearly a hinge space for both the prementary and the premaxilla. More visible in the CT scans is the fact that together they make up premaxillary and prementary plates that allow for a little bit of nipping. This implies a soft or liquid diet. As far as I know this arrangement would be unique among the terrestrial vertebrates of our earth. We can only guess as to their dietary specialization.

The specimen has large, shallow eye sockets with sunken eyelids. There is no apparent nasal cavity, and paranasal sinuses do not exist. The mastoid process is pronounced.

The foramen magnum is square with the skull centered over the cervical vertebrae, which is unique. Human necks insert more posteriorly, which requires the neck muscles to work harder. All of Earth's vertebrate fauna has the insertion of the neck into the posterior of the skull.

Postcranial

For the ease of this description I will be using dorsal vertebrae for the vertebral column. The reason is explained below.

The vertebral formula for *Moultonus dolani* is 5 cervical, 17 dorsal, and 5 sacral, for a vertebral count of 27. In humans thoracic vertebrae are the twelve bones of the backbone to which the ribs are attached. Lumbar vertebrae are the vertebrae situated below the thoracic vertebrae and above the sacrum.

Moultonus dolani's body is the direct reverse of the above definition. She is ribless in the top portion of her body followed by 9 ribs beginning at dorsal 7 and descending down through dorsal 17, where her sacra start.

Moultonus dolani is completely missing several centra in her upper body. Instead they are either absent or in the form of centra plates. It is unclear if this is part of her species natural biology or unique to her. The remaining vertebrae are of a normal design.

Moultonus dolani has horizontal ribs. Each section consists of a centered gastralia with a short rib on each side. The gastralia are clearly visible in the anterior X-rays of the body. The overall rib configuration is unique.

The sacrum is absent of a pelvic girdle.

Moultonus dolani has long slender limbs. The ulna and radius are absent. In their place is a single bone that I have named the "ulnius." The fibula is absent and she has only a tibia.

Each hand consists of 1 carpal (wrist bone) and three fingers, each consisting of a metacarpal and phalanges.

The feet have no ankle bones, no metatarsals, and three toes.

Humans have a postcranial skeleton bone count of 181. *Moultonus dolani* has only 110. This is 71 bones less than we do.

For the comprehensive diagnosis that follows *Moultonus dolani* will, for the most part, be referred to by the type specimen reference number (NA-01) along with all the other individuals that I have assigned NA numbers.

Note: The images that follow provide a large sample for readers to study.

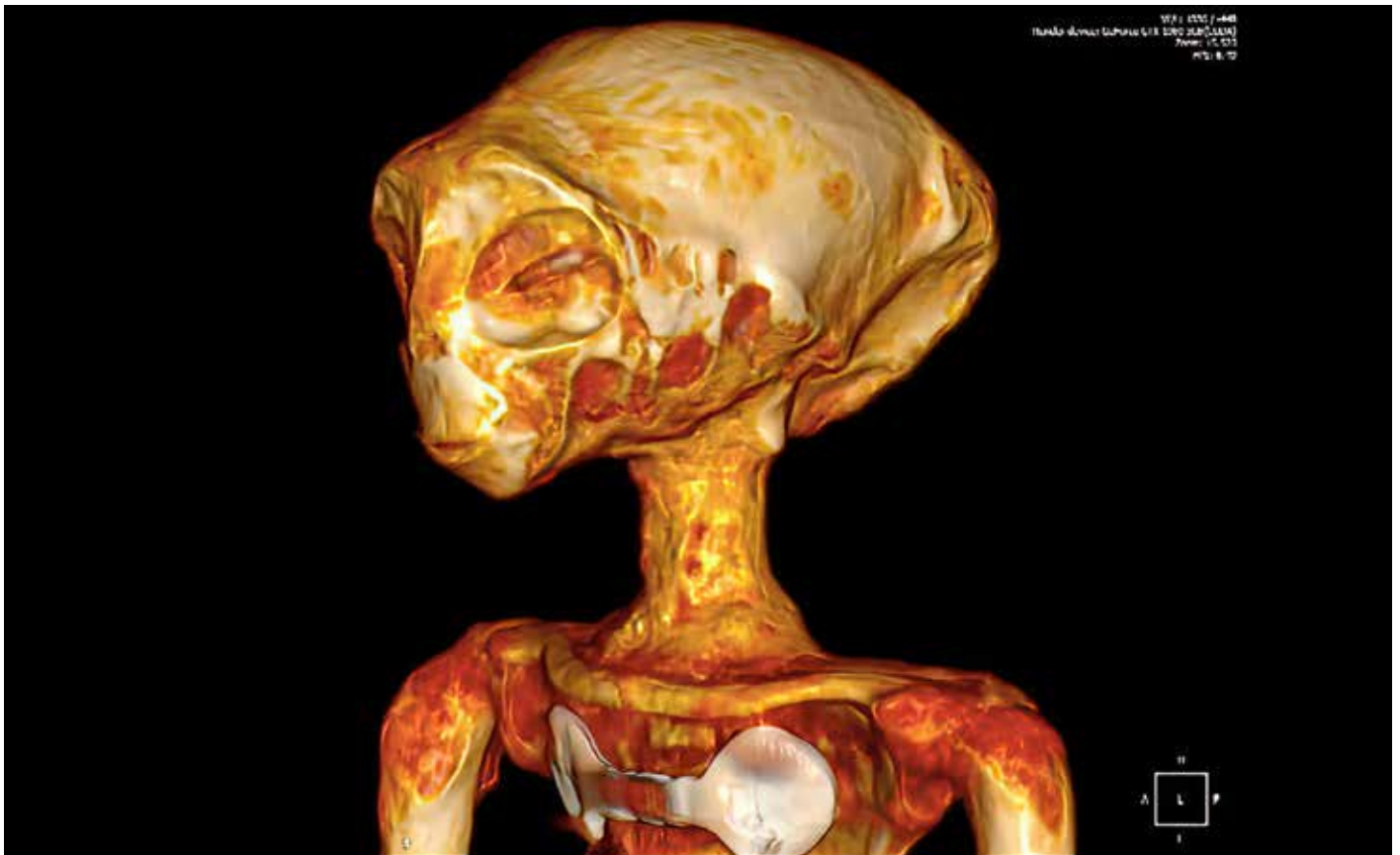

Introductory image of Moultonus dolani.



Left: NA-01 (female), right: NA-02 (male).



Figure 1. NA-01 Moultonus dolani (Type).



Figure 2. NA-01 Moultonus dolani (Type).



Figure 3. NA-01 Moultonus dolani (Type).



Figure 4. NA-01 Moultonus dolani (Type).



Figure 5. NA-02 Alberto skull (Paratype).



Figure 6. NA-02 Alberto skull (Paratype).



Figure 7. NA-02 Alberto skull (Paratype).



Figure 8. NA-03 (Paratype) anterior view.



Figure 9. NA-03 (Paratype) right lateral view.



Figure 10. NA-03 skull (Paratype).



Figure 11. NA-04 skull (Paratype).



Figure 12. NA-04 skull (Paratype).



Figure 13. NA-03 (left) and NA-04 (right) (Paratype).



Figure 14. NA-03 (left) and NA-04 (right) (Paratype).



Figure 15. NA-06, 07, and 08 (Paratype) The Family.



16. NA-Family Member (Paratype).



Figure 17. NA-10 in the flesh (diatomaceous earth removed).



Figure 18. NA-10 ventral view.

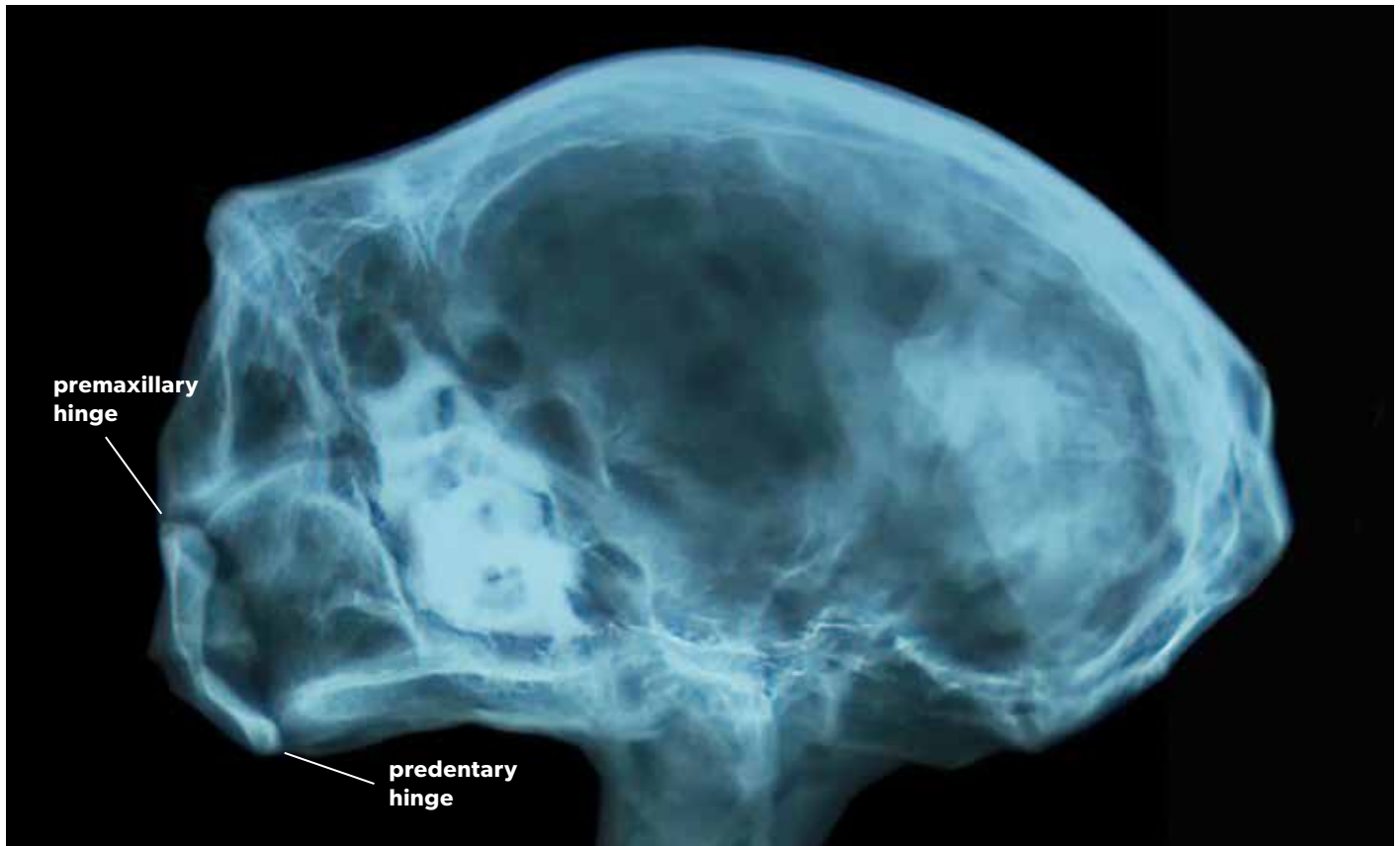

Figure 19. NA-01 X-ray (female).

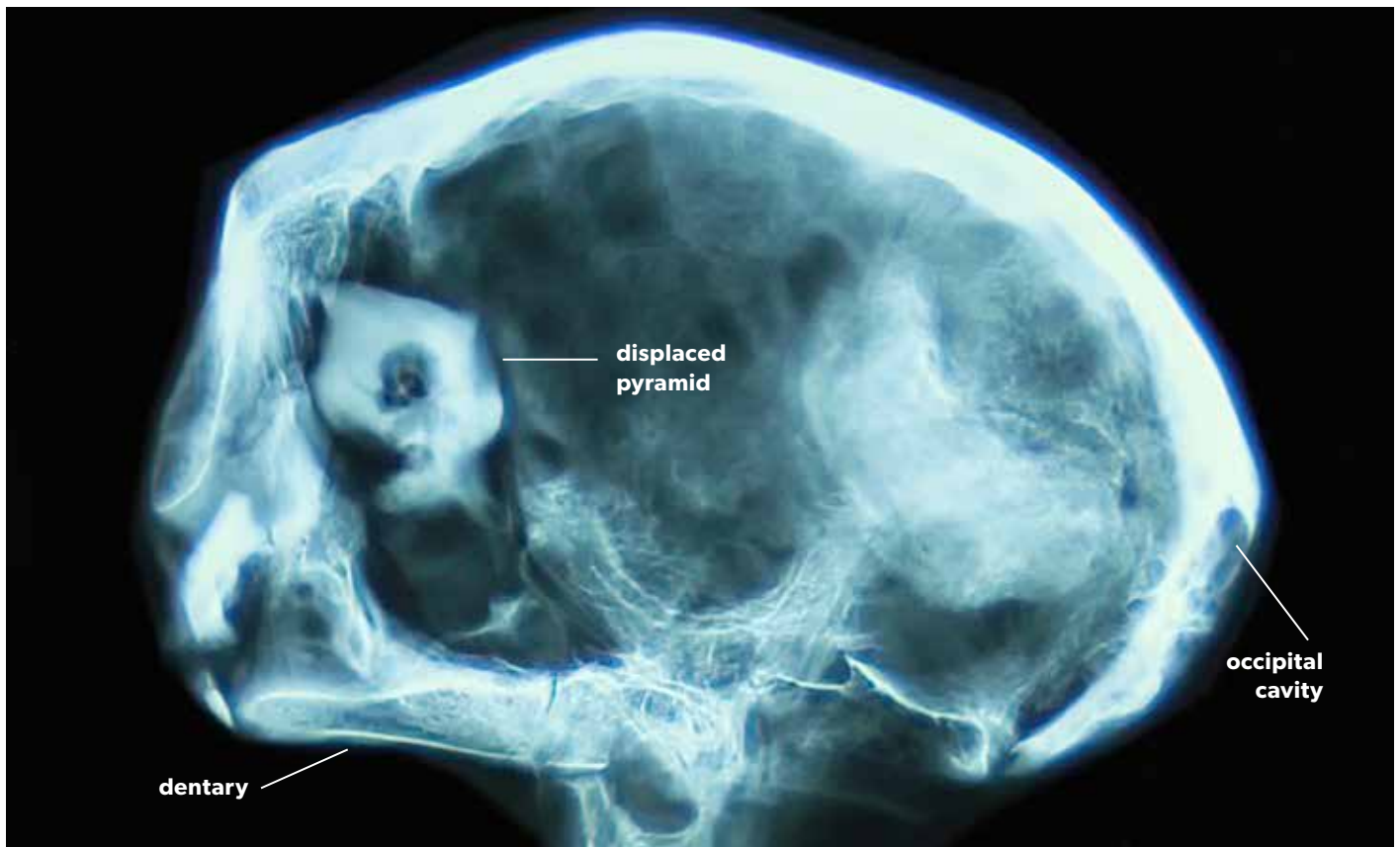

Figure 20. NA-02 X-ray (male).



Figure 21. NA-03 left side X-ray (female).

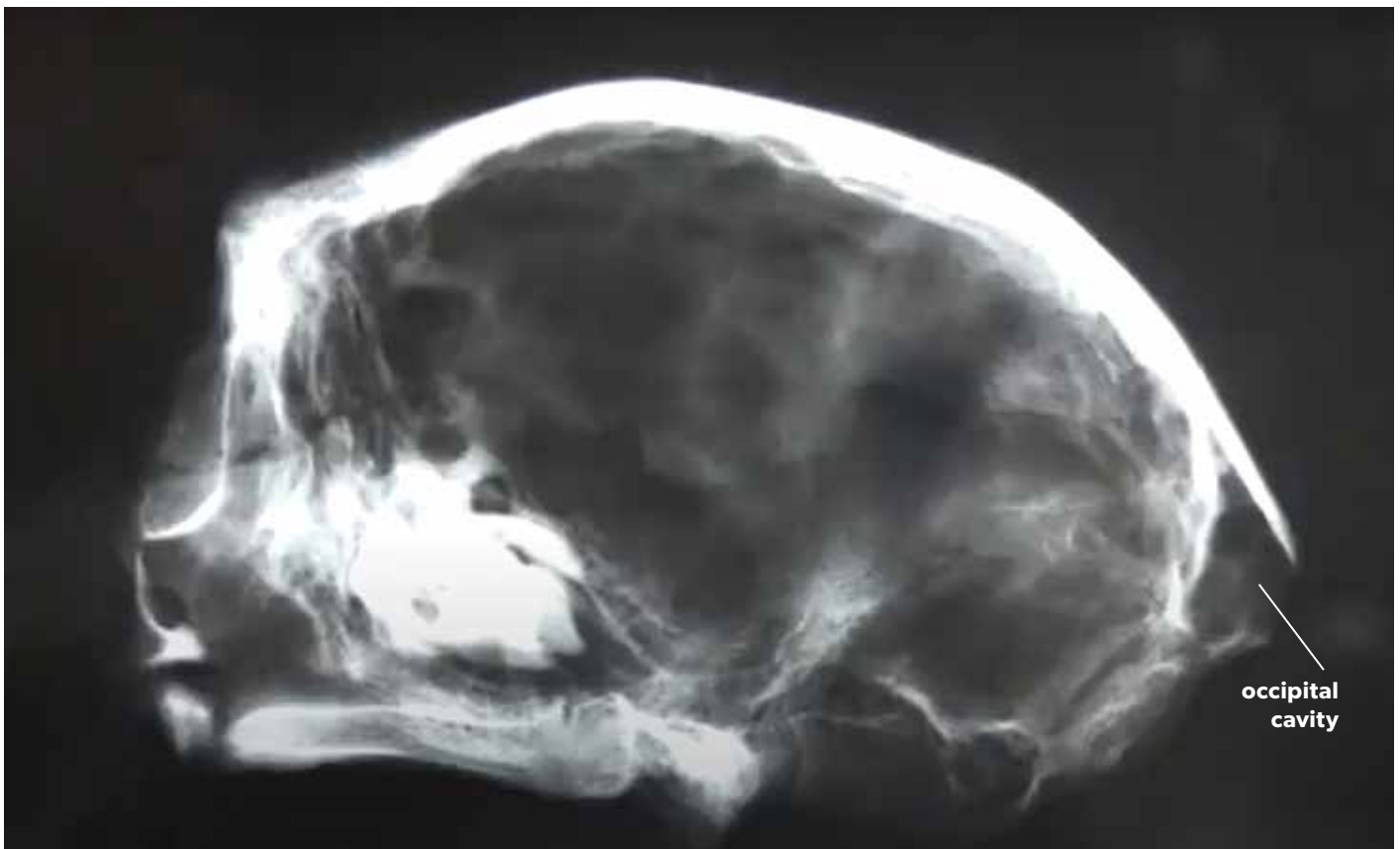

Figure 22. NA-04 X-ray (male).



Figure 23. NA-03 right side x-ray.



Figure 24. NA-01 anterior X-ray of the skull.

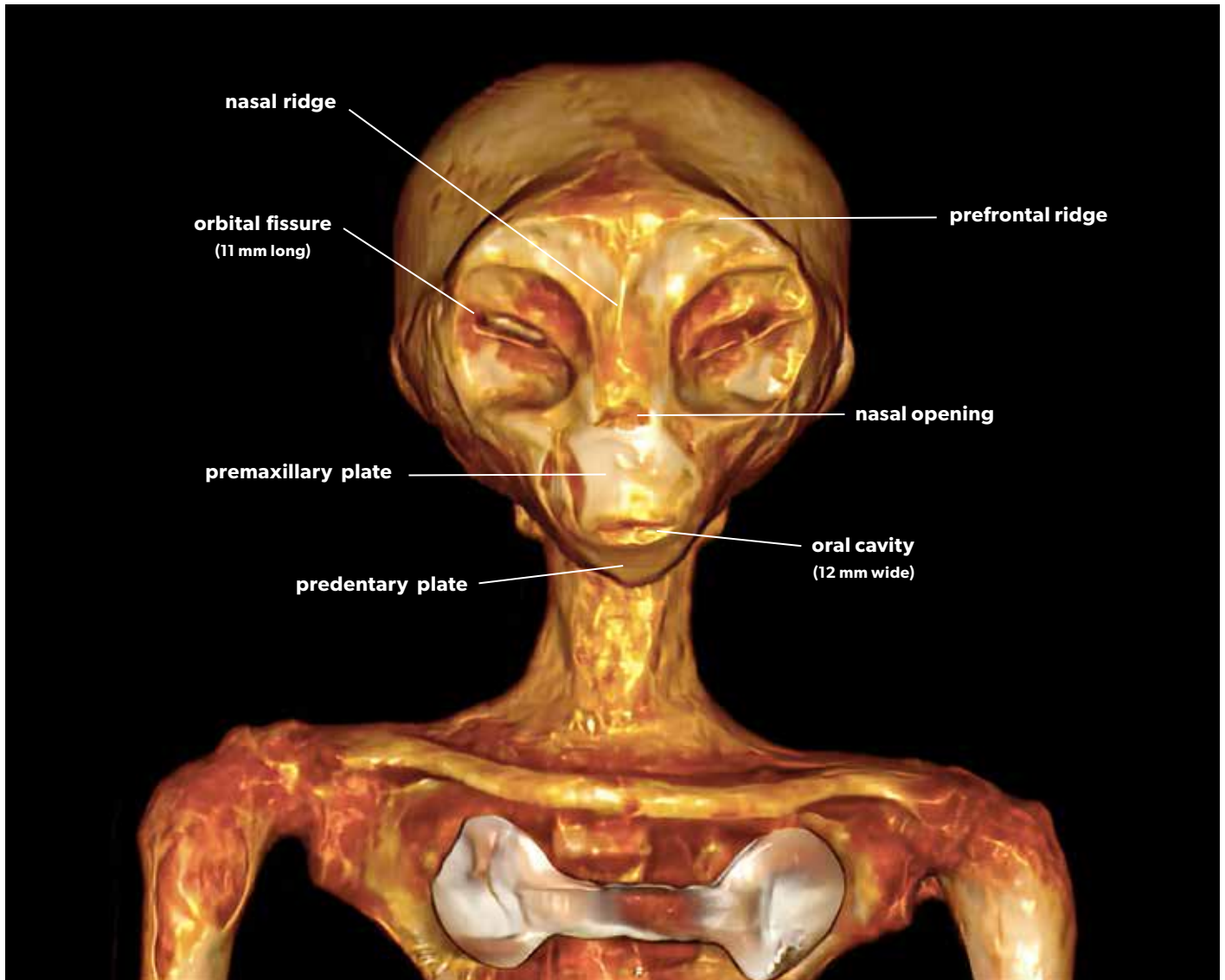

Figure 25. NA-01 anterior.



Dr. Dmitrii V. Galetckii

COMPREHENSIVE DIAGNOSIS

Many of these observations are the work of Dr. Dmitrii V. Galetckii. See *Mysterious Mummies of Nazca: Eyewitness Testimony*, pages 56, 57, 191–228.

Methodology for the measurements

I started with what I considered to be a verifiable number, and that was the 6.4 cm wide medical device. We printed out an image to that scale, which gave us a 1-to-1 ratio of the skeleton. I cross checked other skeletal measurements recorded by the original researchers to verify and create additional actual-size images. All the other images were created on the basis of these measurements. NA-01 is my primary source of scale.

Adults & Juveniles

Sexual dimorphism is apparent in the skulls of *Moultonus dolani*. The female has a more elongated, dorsal ventrally compressed skull, than the male. The male appears rounder when viewed from the side.

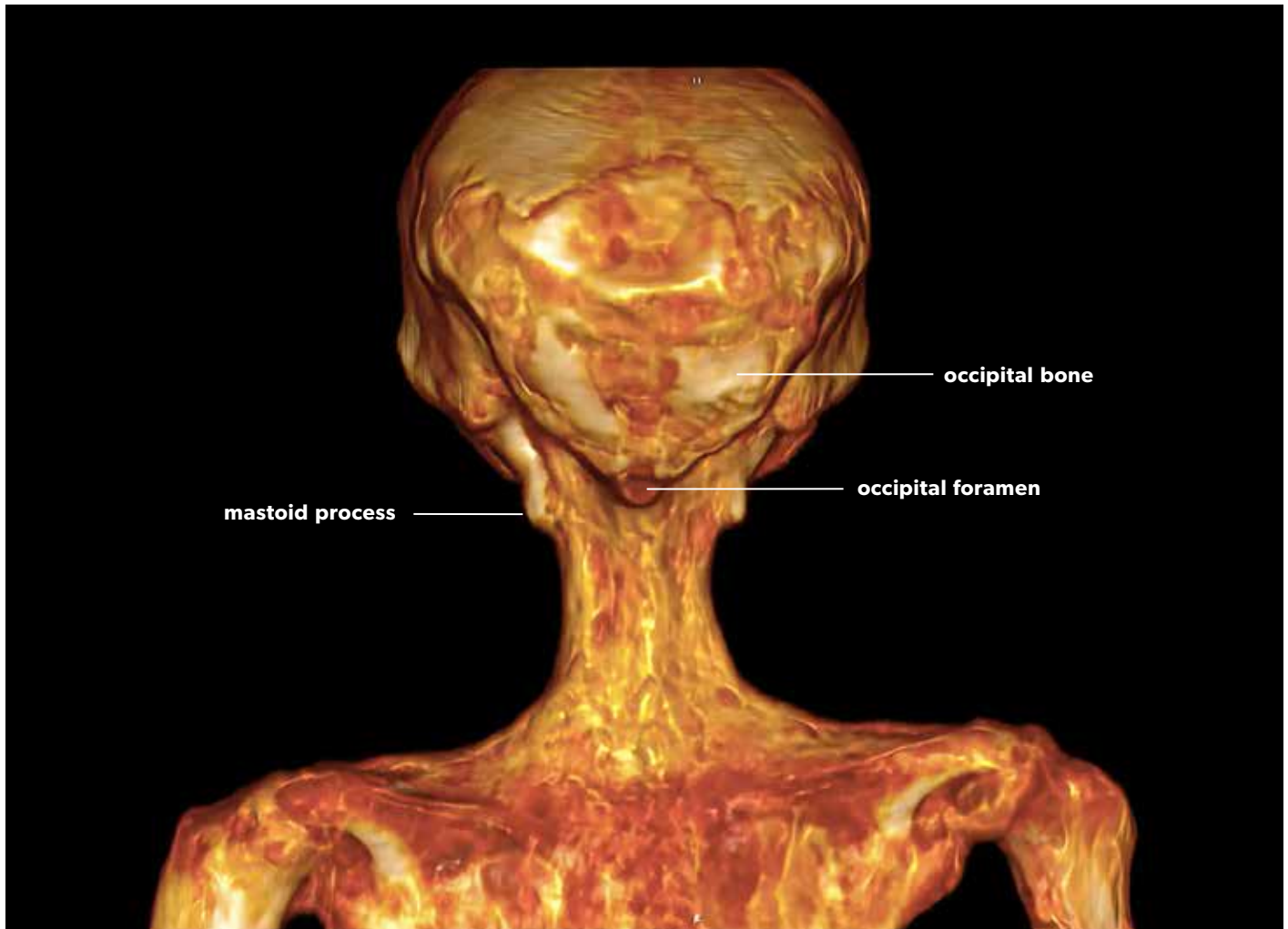

Figure 26. NA-01 posterior.

The skulls of NA-01 and NA-02 appear to be adults. The skulls of NA-03 and NA-04 appear to be more juvenile. These 2 skulls have a larger occipital cavity than in the adults, where it appears to be absent. NA-03 is closer in shape to NA-01 the female while NA-04 is closer to NA-02 which is male. (figs. 19–22)

Skull Description

CRANIAL DIAGNOSIS

When viewed from the front, *Moultonus dolani*'s face and skull is nearly round and resembles our own hominid lineage. It is 7 cm wide and 8 cm tall. Her skull is large in proportion to ours at 12.1 cm long (fig.25). It is anteriorly posteriorly elongated.

From the side you can see that her face, the anterior portion of the skull, is flat. There is a large pronounced prefrontal ridge (fig. 27).

This being lacks what in humans would be a glabella, the smooth area above the nose and between the eyebrows. Instead, she has a **nasal ridge** that divides the skull in half.

She has a paired cavity in the occipital region, which is reduced in the adults. The occipital sinus is not visualized on the CT scans. The absence of sinuses may be due to the absence of the need to heat the air.

The prefrontal bone is 18 mm long (fig. 31). On page 197 of *Mysterious Mummies of Nazca*, Dr. Dmitrii V. Galetkii identifies this bone as part of the frontal. There are frontals, but they are posterior to this bone which clearly has a suture line running across the dorsal-anterior portion of the cranium.

I don't know Dr. Galetkii, but I suspect that he is a physician, and therefore prefrontals would not be

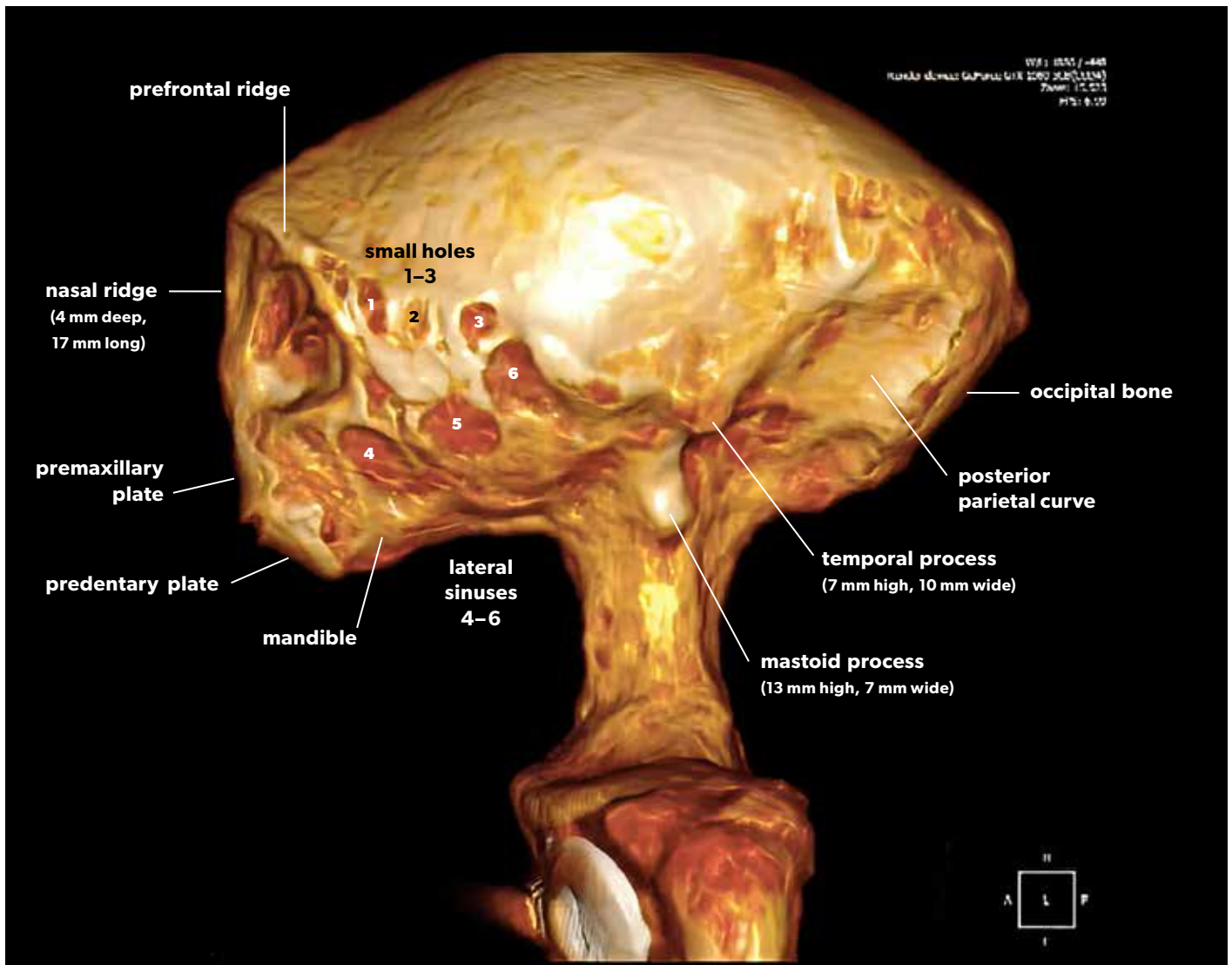

Figure 27. NA-01 left side.

on his radar. Since these bones are prefrontals, they are extremely well developed.

NA-01 appears to have a great cranial capacity for her size, but experts more knowledgeable than I will need to do calculations.

Dorsally the cranium is absent of foramina. The top of the cranium is covered with circular ridge-lines. Their spacing could be suggestive of growth patterns (fig. 29).

Moving from the anterior to the posterior, prefrontals are unique to this species. Frontals are next, followed by parietals and the occipitals. Frontal suture, metopic suture, coronal suture, sagittal suture, and lambdoid suture are all present. The frontal suture is unique to this species since it has prefrontals (fig. 31).

EYES

Eye sockets are quite separated and very large for the size of the skull. They measure 20 mm high and 20 mm wide and are shallow (from 2 mm dorsally to 9 mm ventrally) when viewed laterally (fig. 32).

They have a pronounced edge with sunken eyelids. Behind the slanted eyelids and at the same angle are orbital fissures, which likely serve a dual purpose as the channel for the optic nerve. The right one measures 11 mm wide. Vision range is estimated by the Gaia team as being 180 degrees versus our 140.

NASALS

I am going to assume that the nasals expand laterally to the edges of the orbit and are not invaded by

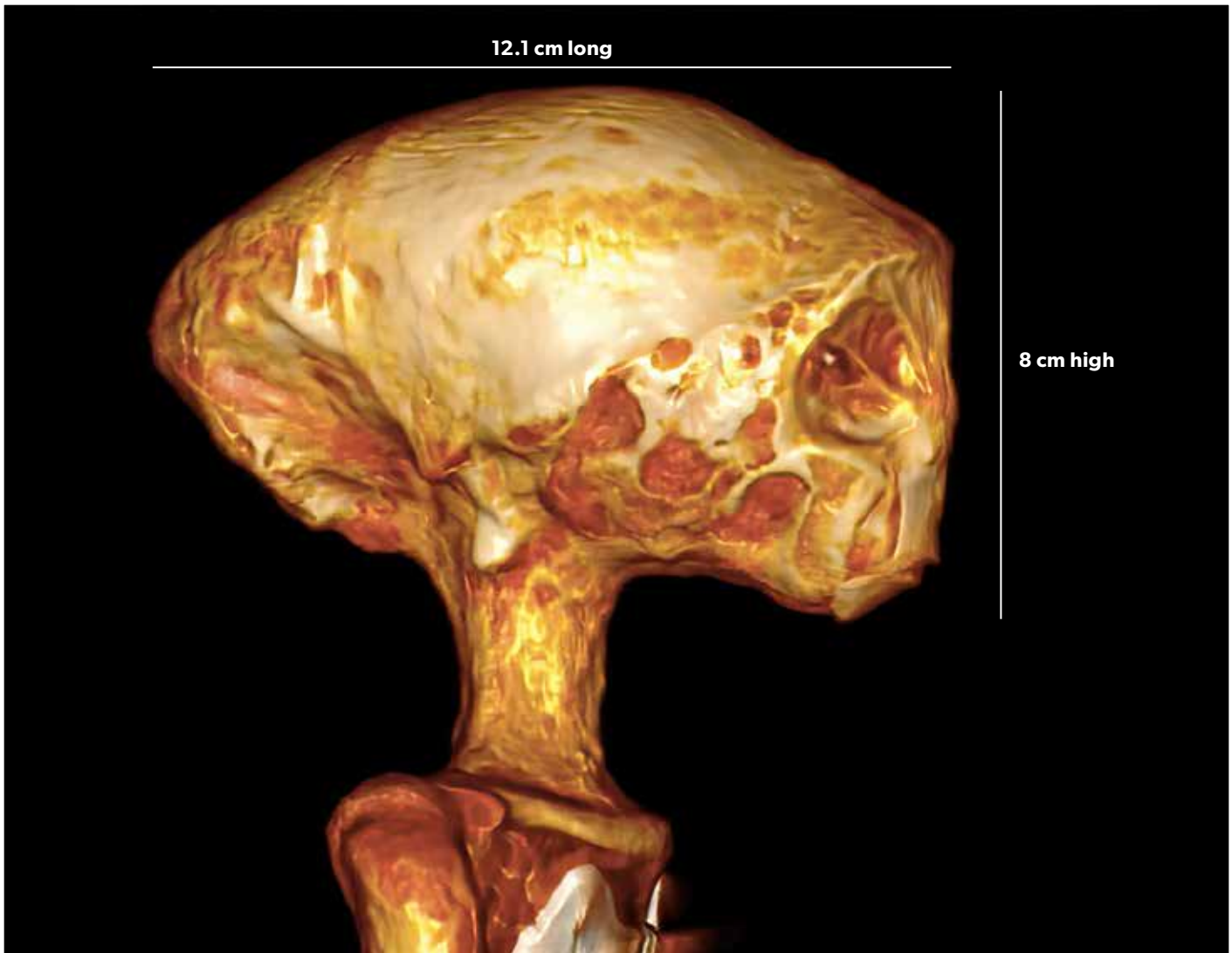

Figure 28. NA-01 right side.

the maxilla like it does in humans. Therefore, it is 12 mm at its narrowest (fig.25).

The nasals form a **nasal ridge** that divides the skull in half. When viewed laterally (fig.27) it is 4 mm at its widest and tapers to a point. It is 17mm high.

The nasal opening is small (fig. 25.), and paranasal sinuses do not exist. The nasal cavity begins at the level of the lower edge of the orbits and presents as an open slit-like cavity 7.5 mm wide and 17 mm high and 3 mm deep.

The nasal cavity is not pneumatized. According to the CT scans, it is filled with a substance with a higher density than air (with x-ray density from 435 to 300 HU, while air density is 1000 HU).

LATERAL CRANIAL FEATURES

Lateral Sinuses: The definition of *sinus* for a unique feature of this species:

1. A bend or curve.
2. Any cavity or hollow formed by a bending or curving.
3. In anatomy and zoology, any of various cavities, hollows or passages, especially, (a) any of the air cavities in the skull opening into the nasal cavities; (b) a large channel for venous blood; (c) a dilated part in a blood vessel, etc.

Near the lateral edge of the eye socket are several small 2 mm holes (fig. 27, #1—3). The first two are about 3mm wide and 6mm high. The third has a round shape and a diameter of 4.6 mm. The holes are



Figure 29. NA-01 dorsal view of skull. Circular ridge lines cover the cranium.

interconnected by a system of channels. Number 2, opens into the pyramid (fig. 36) and possibly serves as a vestibular apparatus. The vestibular system in vertebrates is the system that creates a sense of balance

The *Moultonus dolani* skull has three cavities that run anteriorly/posteriorly along the maxilla and extend well into the temporal region (fig. 27, #4—6). I have labeled these cavities as lateral sinuses.

Lateral sinus 6 is a large spherical hole 8.5 mm in diameter and 5 mm deep. Being in the temporal area and extending to the inner cortical plate, it is connected with the pyramid through a narrow passage. If this hole acted as an organ of hearing, then the vertebrate species of Earth have the reverse order—first the organ of hearing (external auditory meatus), then the pyramid.

As far as I can tell there isn't a single example in the fossil record or among our current living vertebrates here on earth with lateral sinuses. This is another point that favors their alien origin.

It was reported to Linda Moulton Howe by one of her anonymous informants that some alien species preferred to float rather than walk. They have also been reported to float into people's bedrooms. If that is indeed the case, then they would require a highly developed vestibular system. This might explain the complexities on the lateral sides of the

skull. So, is less bone necessary for increased sensory perception?

A being would need a highly developed sensory system in order to create the sense of balance and spatial orientation for floatation movement. Speculation, I know, but until someone comes up with a better explanation, I am going to go with it. I have no problem being wrong.

In the future if these features are deemed to be vestibular sinus, then the name can be changed. For the purpose of this paper I will use *lateral sinus* for all three.

Mastoid Process: These bodies have a pronounced mastoid process. It is 13 mm high and 7 mm wide. Muscles fixed to them (sternocleidomastoid muscle in humans) perform the function of head rotation and nodding (figs. 33–35).

This is important to students of fossil humans because it occurs regularly in our hominids. The development of the mastoid process is related to the upright posture of hominids and the consequent evolutionary realignment of the head in relation to the neck. These beings have an upright posture, they walked on two legs, so the development of the mastoid process is to be expected.

Temporal Process: Above and behind the mastoid process is a feature I am calling the temporal process. It is 7 mm high and 10 mm long. Its purpose is

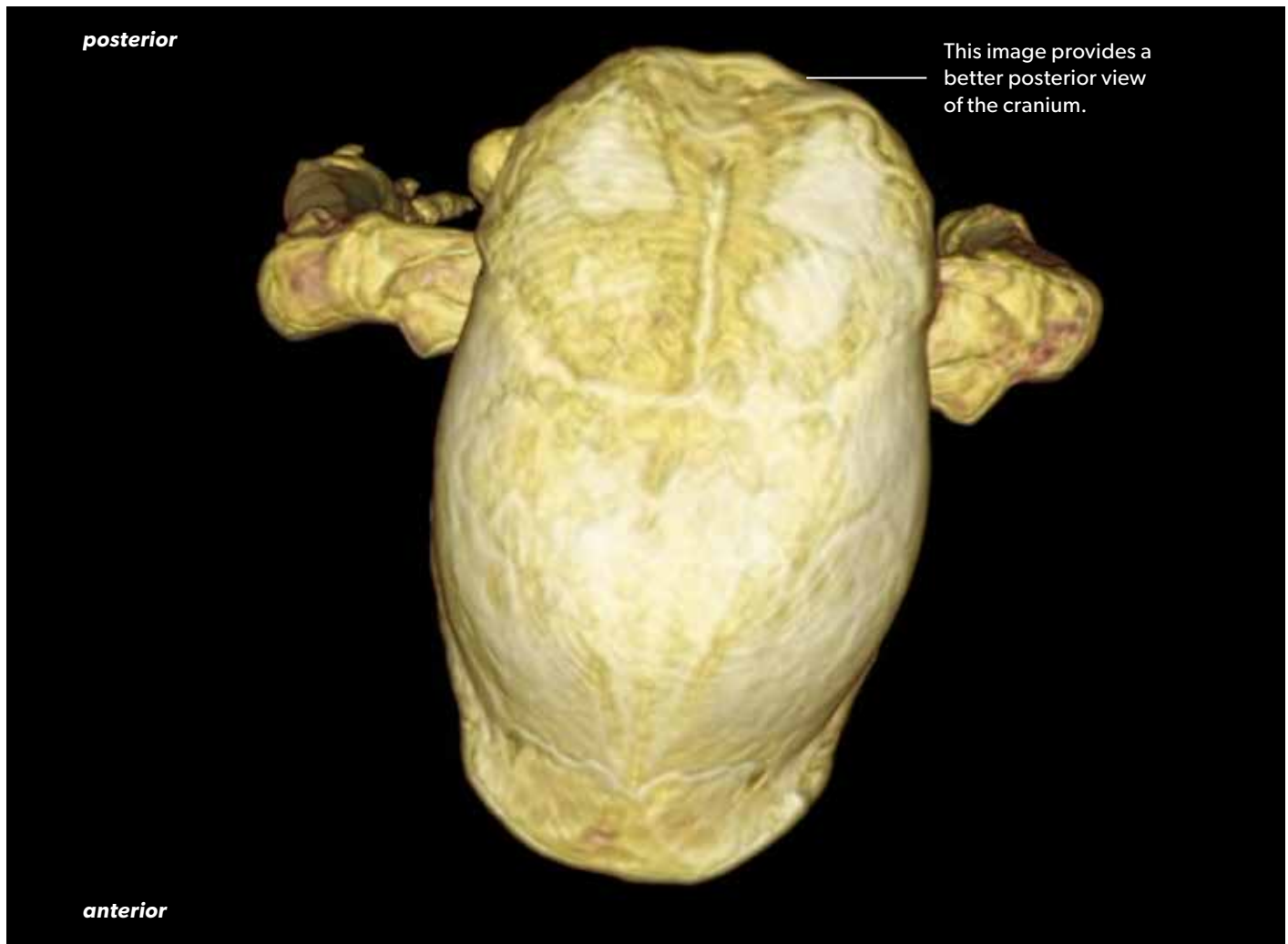

Figure 30. NA-01 posterior/dorsal view of skull (12.1 cm long, 7 cm wide).

unknown, but it appears to be a significant feature, so I decided to point it out and give it a name as reference for future researchers (fig. 35)

Posterior Parietal Curve: Posterior to the temporal process is a curved portion of the cranium. When viewed posteriorly it is pinched in. I have named it the posterior parietal curve (figs. 33 and 35).

Occipital Foramen: In humans the occipital bone is triangular in shape with the tip pointing up. In *Moultonus dolani* the point meets at the bottom, which is the location of another unique feature I have labeled as the occipital foramen (fig. 26). The occipital foramen is oval in shape and measures 6 mm wide and 4 mm tall.

Foramen Magnum: The base of the skull has a square shaped Foramen magnum, which is large for the size of the skull (fig. 14 and 37). In apes and

humans the foramen magnum is located more posteriorly and is rounded.

Most important is the location of the foramen magnum, which is centered over the cervicle column—a unique characteristic. This makes for a very balanced skull from a biomechanical stand point.

Human necks insert more posteriorly into our skulls, which requires our neck muscles to work harder. All of Earth's vertebrate fauna has the insertion of the neck into the back of the skull where the skull hangs off of the neck at an angle.

NA-10: THE YOUNGEST SKULL

NA-10 is the most juvenile skull of all. The lower jaw looks to be cut off the X-ray. The value of the NA-10 X-ray lies in the ventral view. It is only the third ventral view I have for the paper. In it you can see clearly that the mandible is less developed than in the

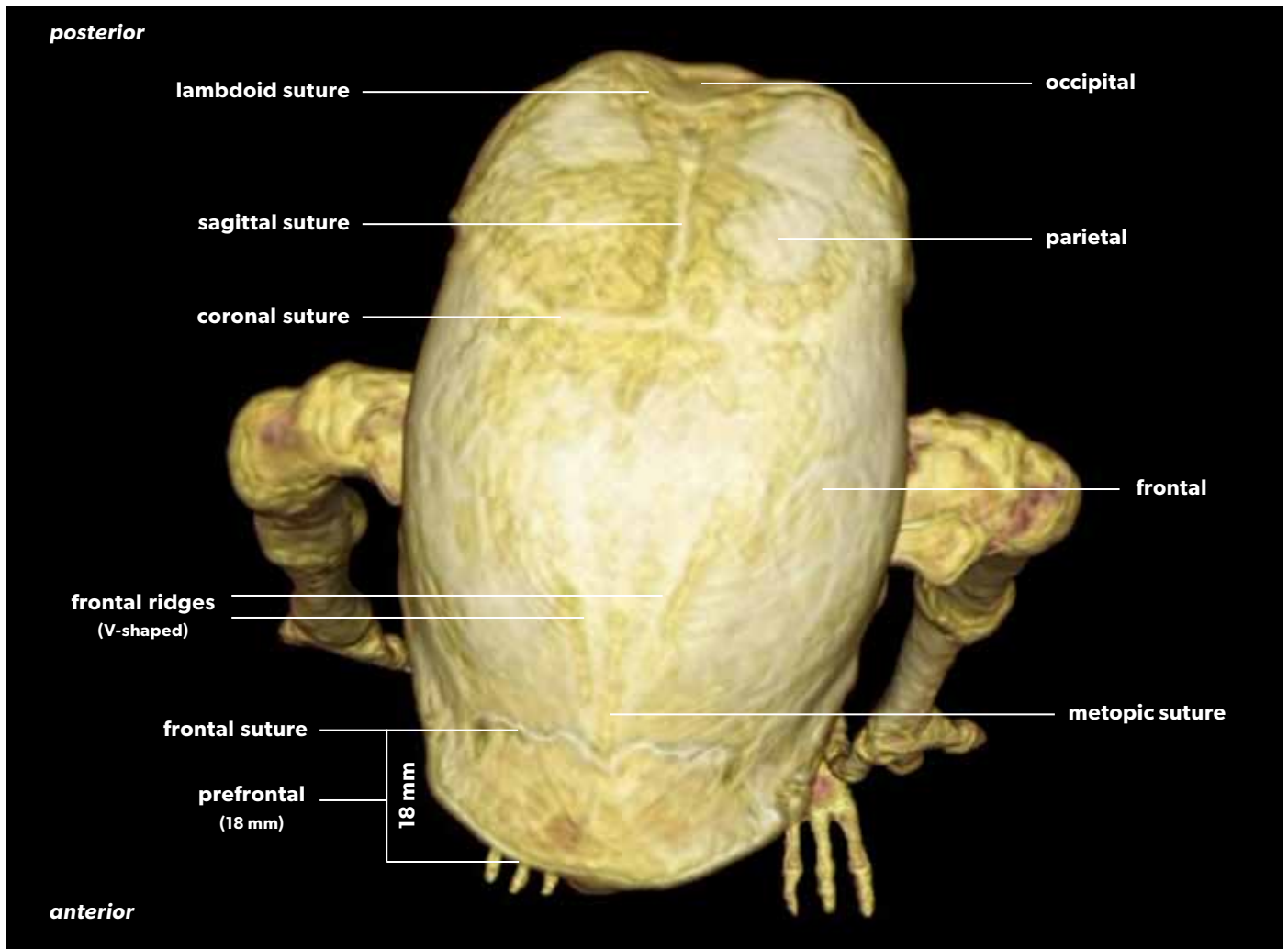

Figure 31. NA-01 dorsal/anterior view of skull (12.1 cm long, 7 cm wide).

adults. The pyramid is present. (See fig. 38.) [Source of the NA-10 X-ray: instituto-inkarri.com/en/]

MANDIBLES

They have very small, short concave mandibles on the lateral surface (fig. 27). They are without teeth (fig. 19).

In the ventral view of the family member x-ray you get the best view of the overall shape of the mandible (fig. 39).

On page 56 of *Mummies of Nazca*, Dr. Korotkov states that the “lower jaw (mandible) is present and fused with the rest of the bone of the skull.” I am going to take their word for it since I am not able to independently verify this aspect. How much mandible movement there is can only be guessed at.

On page 202 of *Mummies of Nazca*, is the CT scan of the left mandible joint (fig. 40). The arrangement of the condyloid process and quadrate appears

unique, having a bit of a ball and socket feel, with the quadrate acting as the ball and the condyloid process being more socket-like. The quadrate is angled posteriorly and very rounded. The quadrate articulates with the condyloid process laterally. The condyloid process abuts the quadrate medially.

The joint looks to be unencumbered. However in the X-rays it appears that the mandible could be bound up posteriorly. This is likely, since you can clearly see the rounded (unique) articular joints for both the premaxilla and prementary in the X-rays (fig. 20). Premaxilla are fused midline forming a premaxillary plate (fig. 25). The prementary (as seen in the dinosauria) has also formed a fused prementary plate. The original researchers and I came to this conclusion independently.

The prementary and premaxilla have taken the place of the teeth and lower jaw for mastication. The

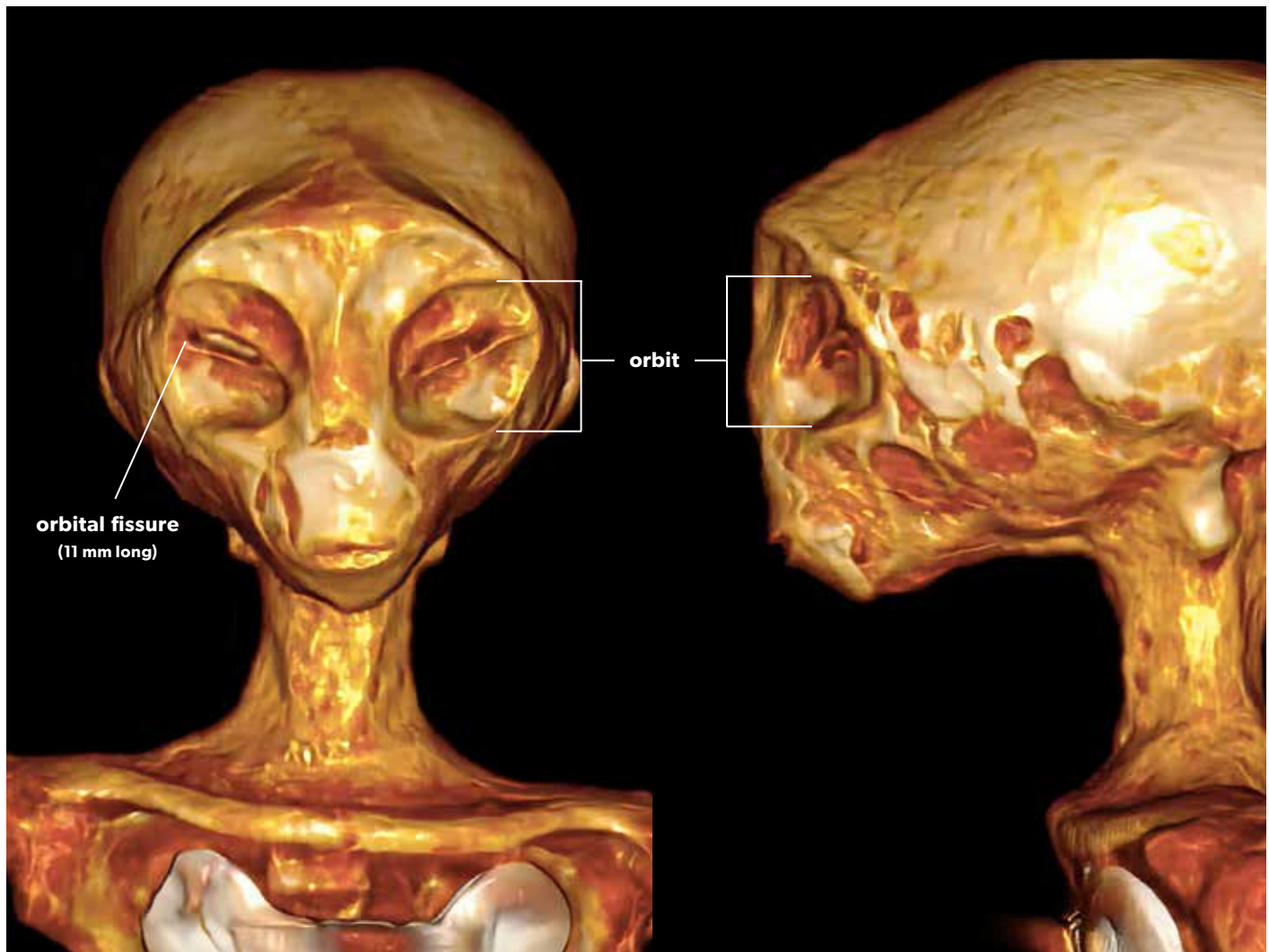

Figure 32. NA-01 eyes.

absence of teeth implies weak jaw mechanics. In lateral view X-rays of the skulls, you can see clearly a hinge space for both the prementary and the premaxilla. You can see in the CT scans that together they make up a premaxillary and prementary “plate.”

A remarkable aspect of this species is that whatever mastication occurs, it is performed by a combination of premaxillary and prementary plate movement. You can see clearly that these plates are what surround the oral cavity (12 mm wide). Movement is achieved in an anterior/posterior way, which I would describe as a nipping movement.

This appears to be unique among all of the higher vertebrates. I am unaware of premaxillary and prementary movement used as part of the eating process. We can only guess as to their dietary specialization.

There are 2 curved plates resembling a hyoid bone (fig. 41). They are behind the plate of the lower jaw, symmetrical, and spliced along the midline with the base of the skull. The space between the skin and this bone may be a short throat.

The mastication plates on right side of the type specimen are pathological (fig. 42), which is attributed to a stab wound in *Mysterious Mummies of Nazca*. The mastication plates on the left side appear normal (fig. 43). They have a symmetry to them that is absent on the other side.

INTERIOR OF THE SKULL

The occipital part of the skull is rather sharp. In the occipital region there are several cavities between the cortical plates (fig. 44). The maximum height of the



Figure 33. NA-01 pronounced mastoid process.

main cavity is 27 mm. The maximum depth is 5.5 mm, and the width is 24 mm.

On the inner surface of the parietal region along the midline, from the frontal bone to the middle, a furrow passes, an analogue of the furrow from the upper sagittal sinus (fig.45). In the cavity of the skull remains of the brain are visible.

Pyramid: A pyramid in anatomical terms is a feature that is described as a more or less pyramidal

shape. Dr. Dmitrii V. Galetckii has applied this term to the dense bone formation (2350 HU) located behind the malar area and below the temporal area inside the skull. (figs. 36 and 37).

These dense bone formations are located on the anterior third of the skull, laterally, with a system of channels/openings extending to the lateral surface of the skull.

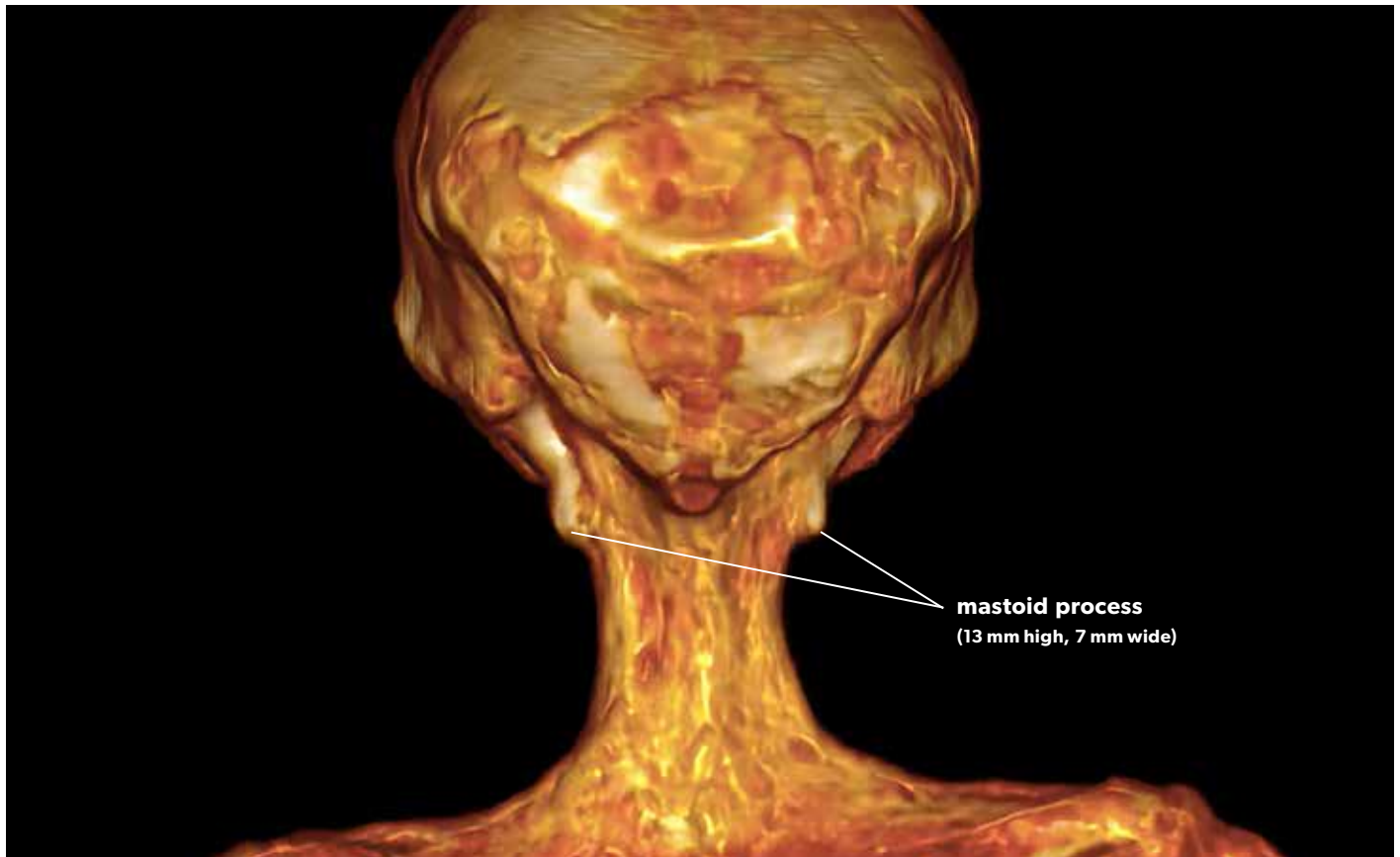

Figure 34. NA-01 pronounced mastoid process.

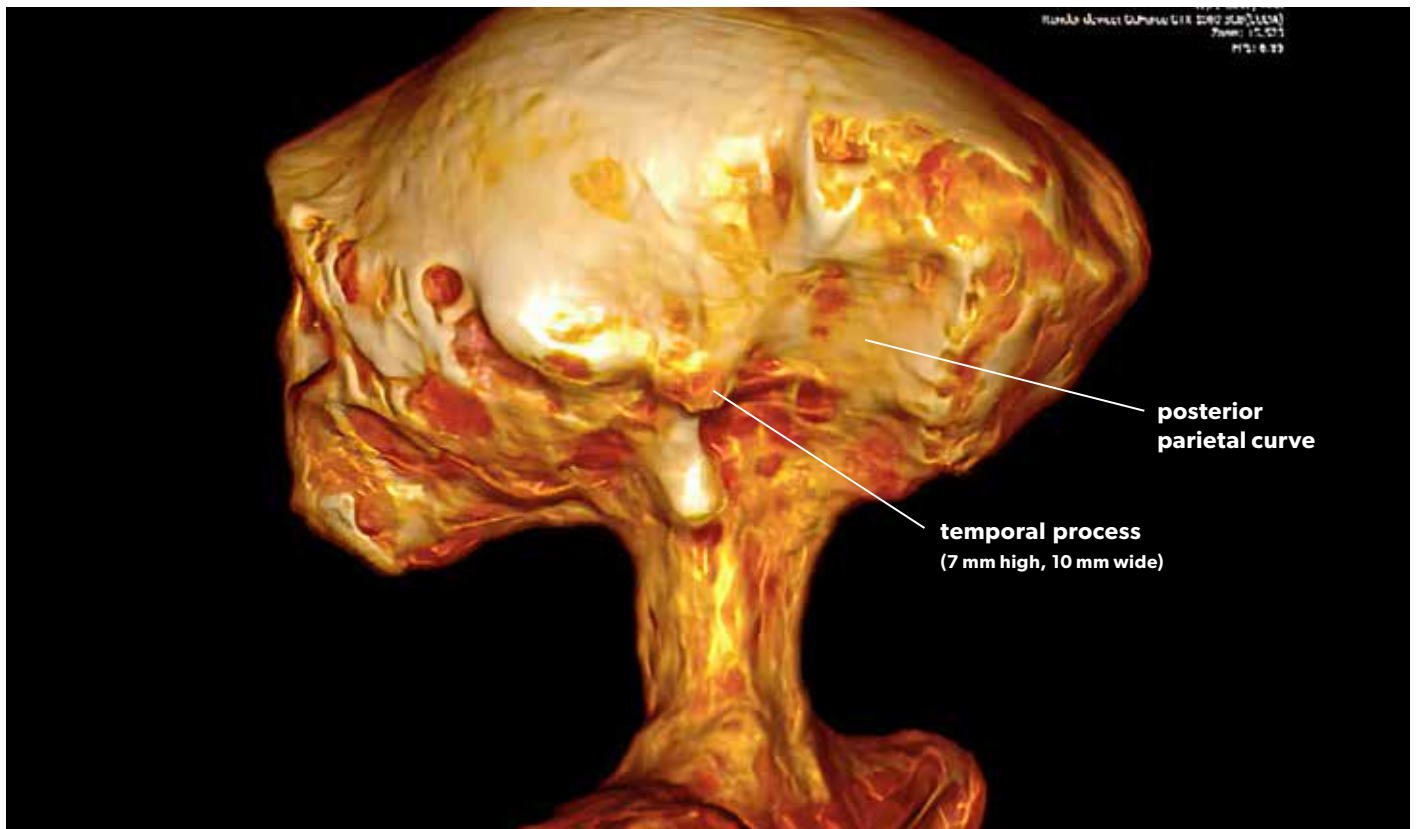

Figure 35. NA-01 temporal process and posterior parietal curve.

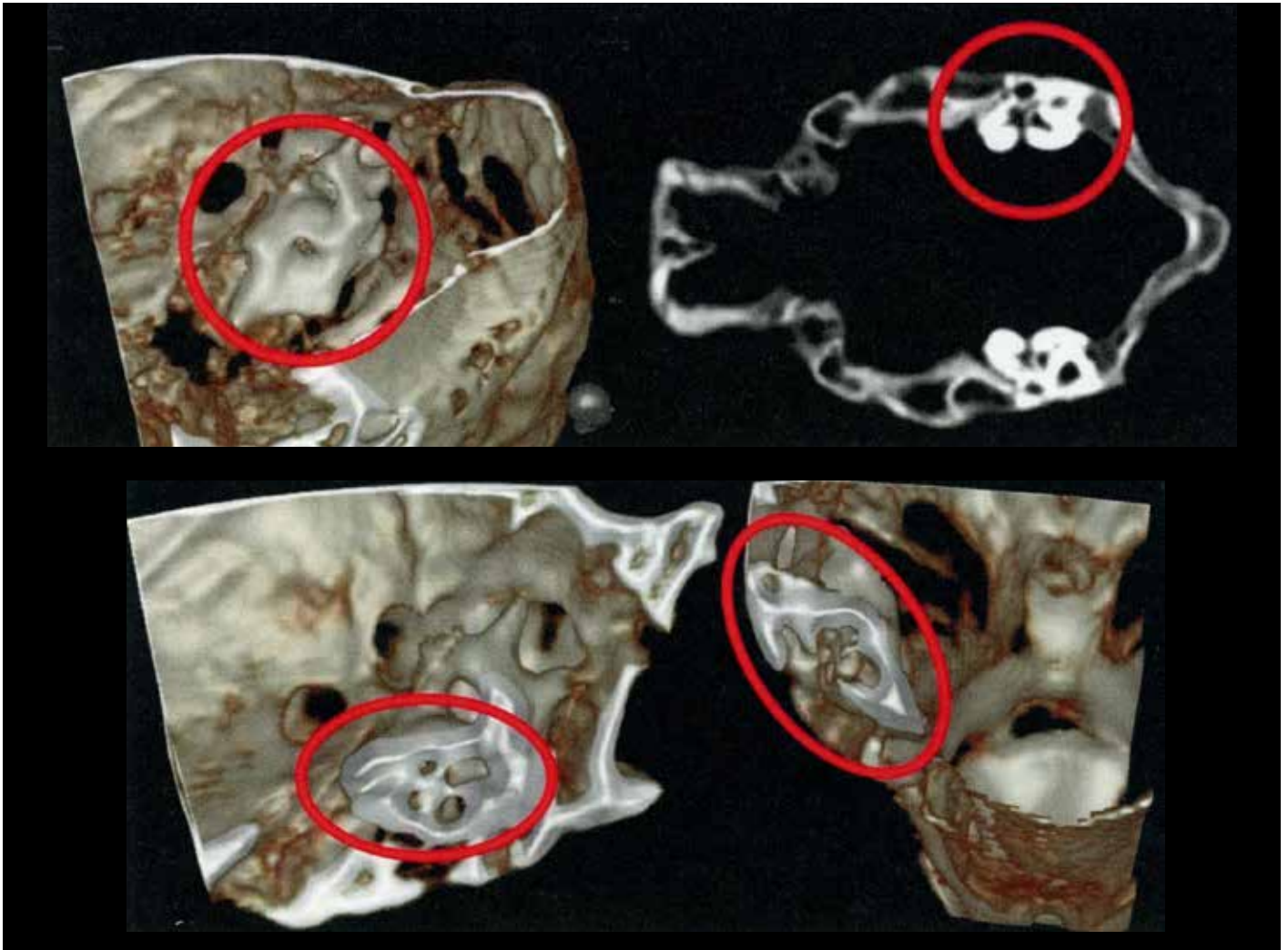

Figure 36. Sagittal slice and obliquely horizontal slice of the pyramid.



Figure 37. NA-03 ventral x-ray. Pyramid is indicated by the blue arrow; the foramen magnum is within the red circle.



Figure 38. NA-10, the youngest skull, right side and ventral X-ray.



Figure 39. NA 06, 07, or 08 (family member) ventral X-ray.

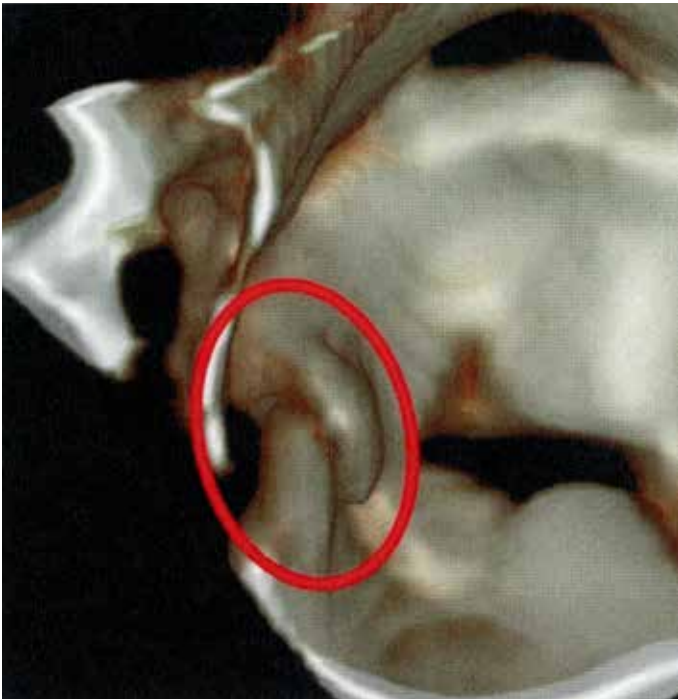

Figure 40. condyloid process left and quadrate right.

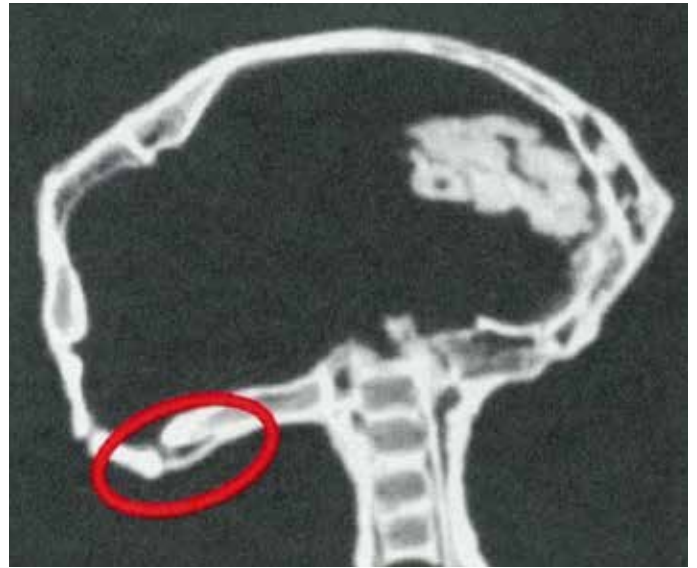

Figure 41. NA-01 hyoid.

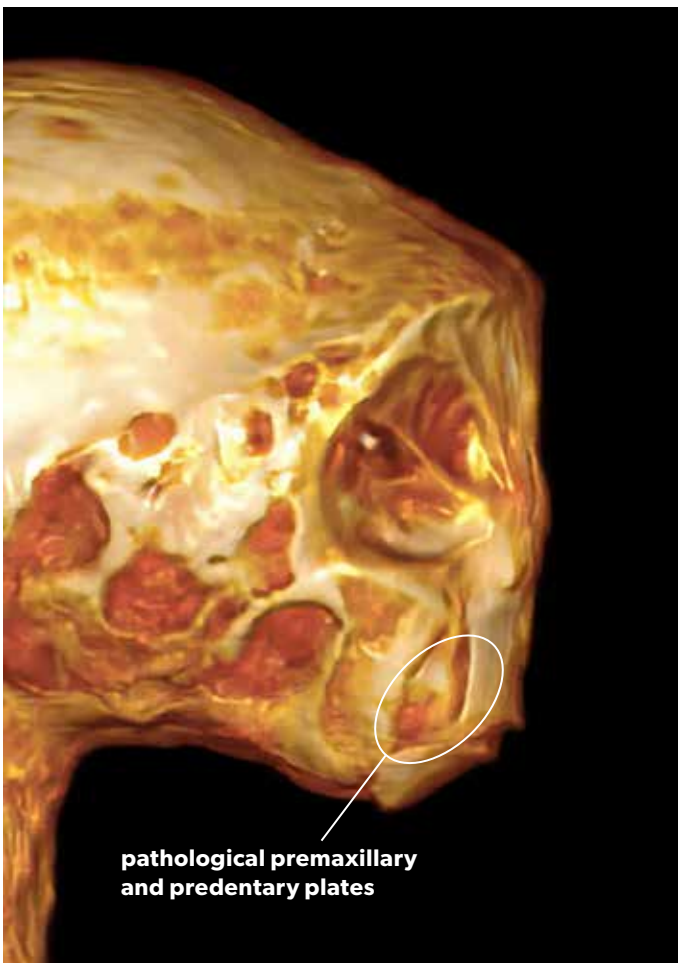

Figure 42 . NA-01 pathological right side.

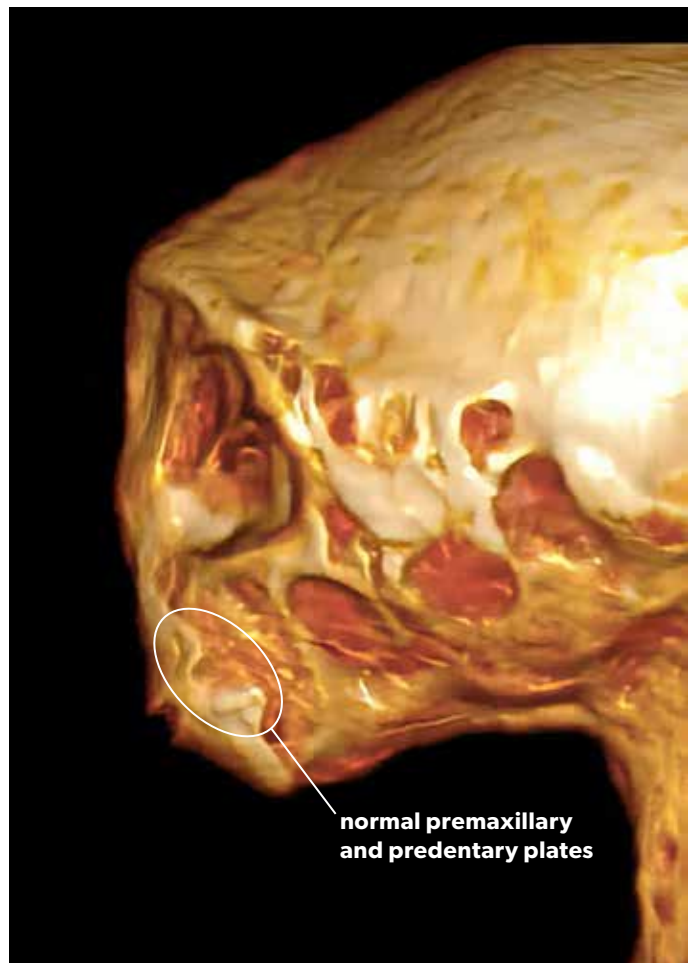

Figure 43. NA-01 normal left side.



Figure 44. NA-01 occipital region.

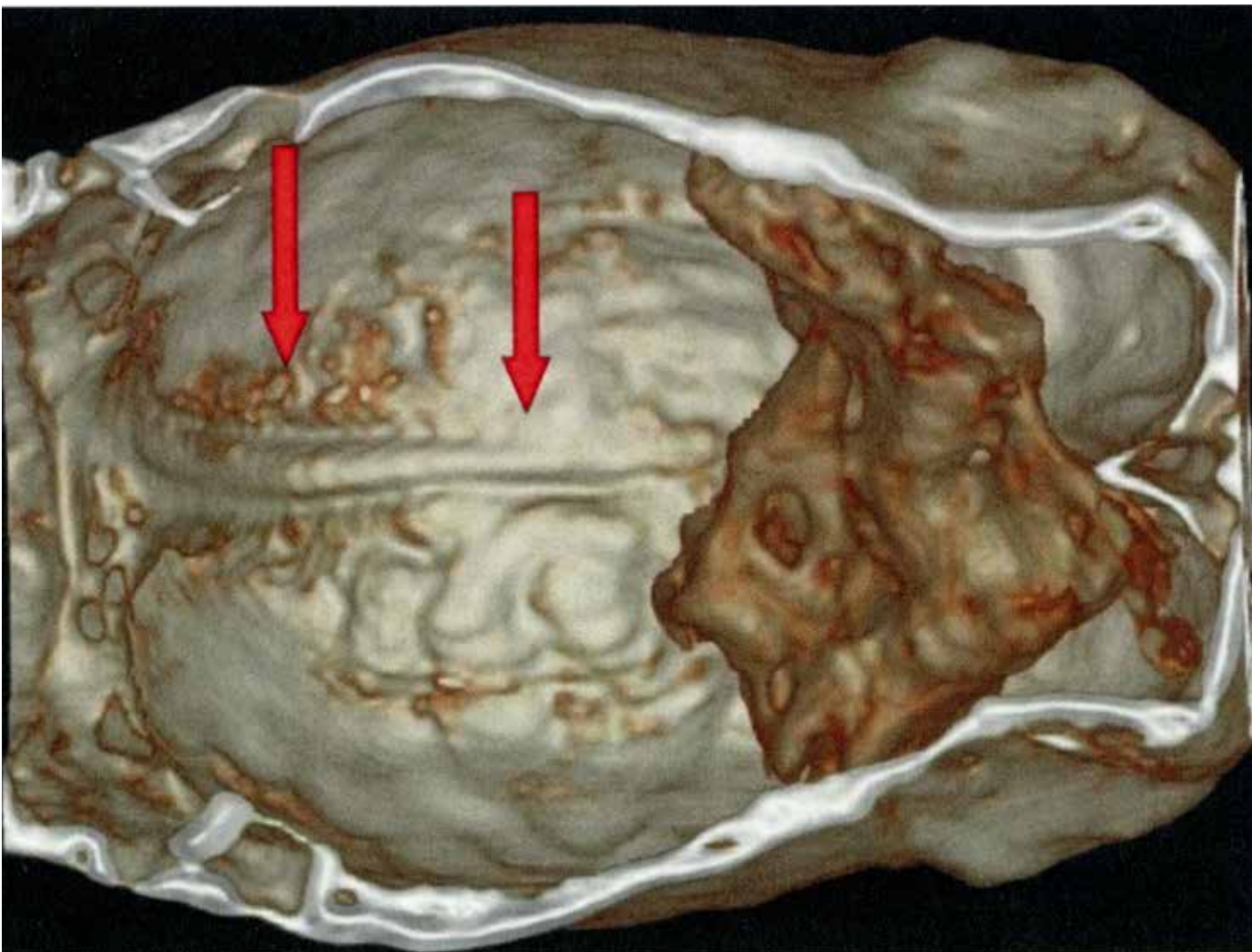

Figure 45. NA-01 furrow of the superior sagittal sinus.



Figure 46. NA-01.



Figure 47. NA-01.

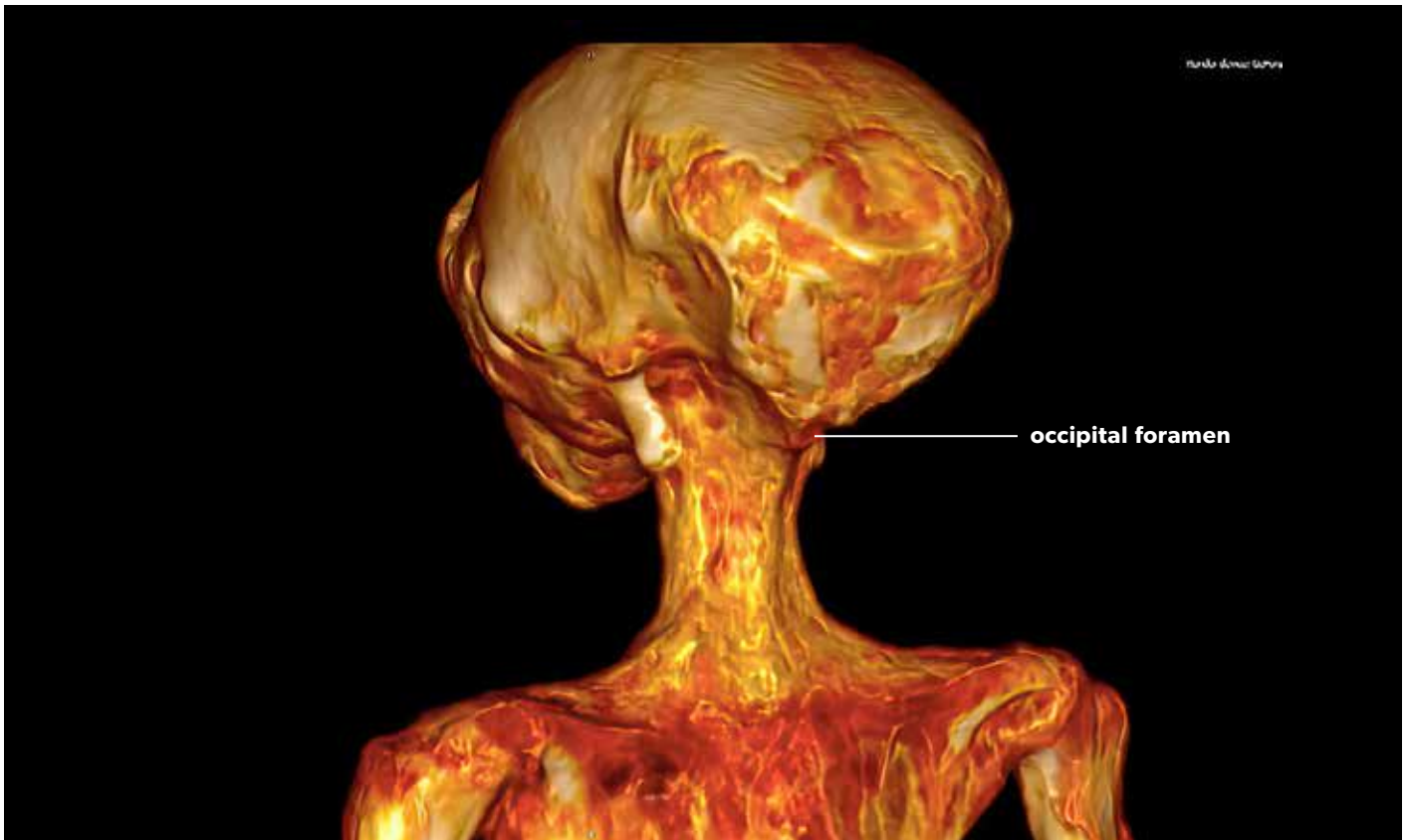

Figure 48. NA-01 occipital foramen.

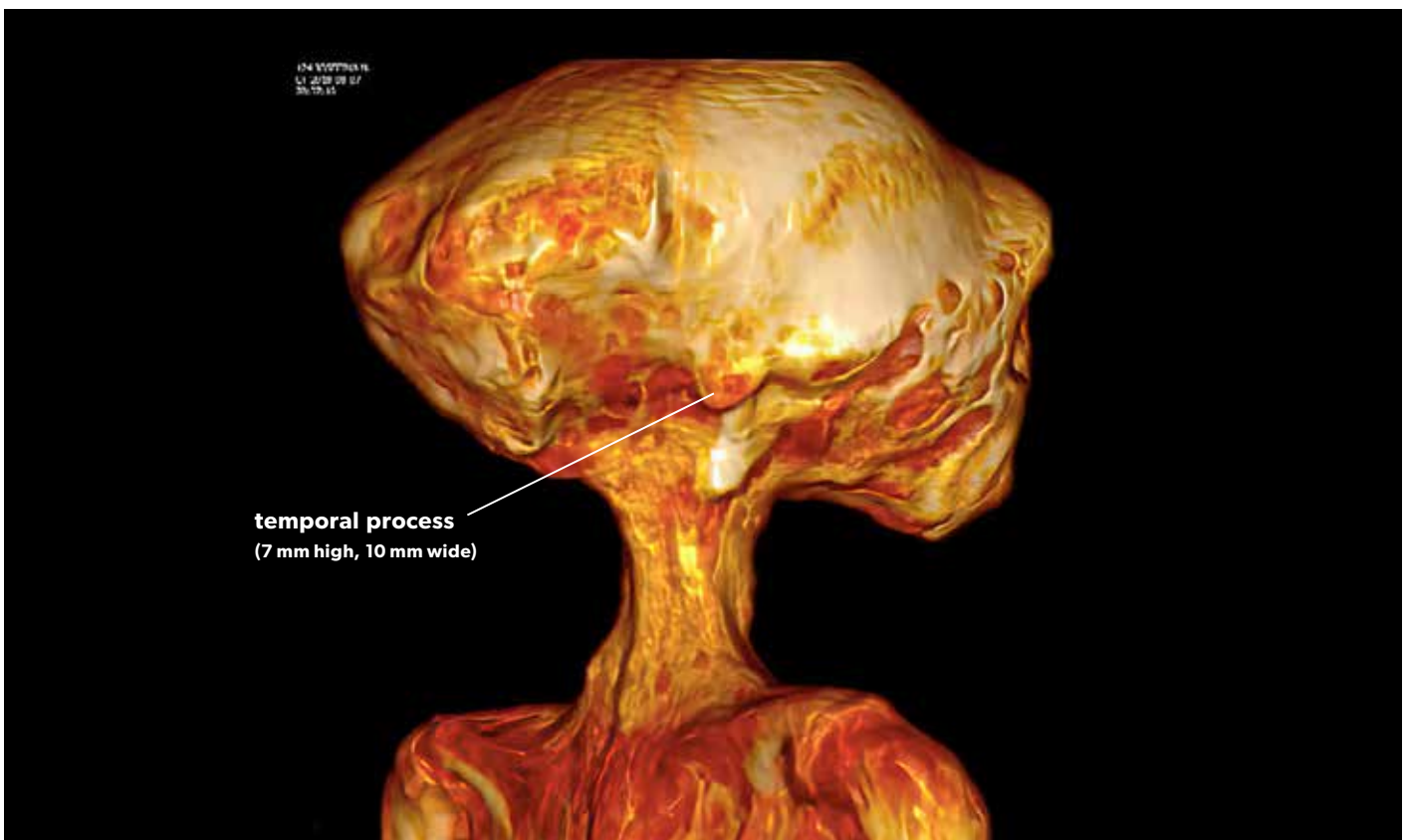

Figure 49. NA-01 temporal process.

Vertebral Column Description

The vertebral column consists of 27 vertebrae—5 cervicle, 17 dorsal, 5 sacral. The following is my methodology for assessing the vertebral count.

1. In figure 51 you can clearly see the first 4 cervicles. That left space for one more cervicle to reach the clavicles for a total of five.
2. I used the anterior X-ray of NA-01 to count the 5 dorsal transverse processes that are easy to see. Dorsal 6 has no transverse processes or ribs (fig. 55).

3. I used the NA-01 left side X-ray. Starting with the ribs, I worked up the column, matching spine tops with ribs. I concluded that rib 1 is attached to dorsal 7 (fig. 56).
4. I used the sacrum X-ray of NA-02 for the sacral count, as well as the NA-01 ilia ligaments image from *The Mummies of Nazca* referenced later in this paper (figs. 57 and 99).

The posture of *Moultonus dolani* is more vertical than humans. This is because the vertebral column, especially in the upper third of the skeleton, is straighter than our own. This is also because her skull is centered more squarely over the neck.

CERVICLES

Cervicle vertebrae are always counted to the pectoral girdle. *Moultonus dolani* has 5. The authors of *The Mummies of Nazca* assigned 10 cervicle vertebrae in their description. It took significant time to figure out their vertebral arrangement so that I could clearly understand what they were describing. Then I made my adjustments and have endeavored to describe *Moultonus dolani* NA-01 with the methods and terms I am familiar with.

Cervicles 1–4 have robust centra in proportion to the neck (fig 51). Cervicle centra are opisthocoealous cylinders with a height of 7.8 mm, a width of 13 mm, and a length of 9 mm. Between the



Figure 50. NA-05 Opisthocoealous cervicle surface.

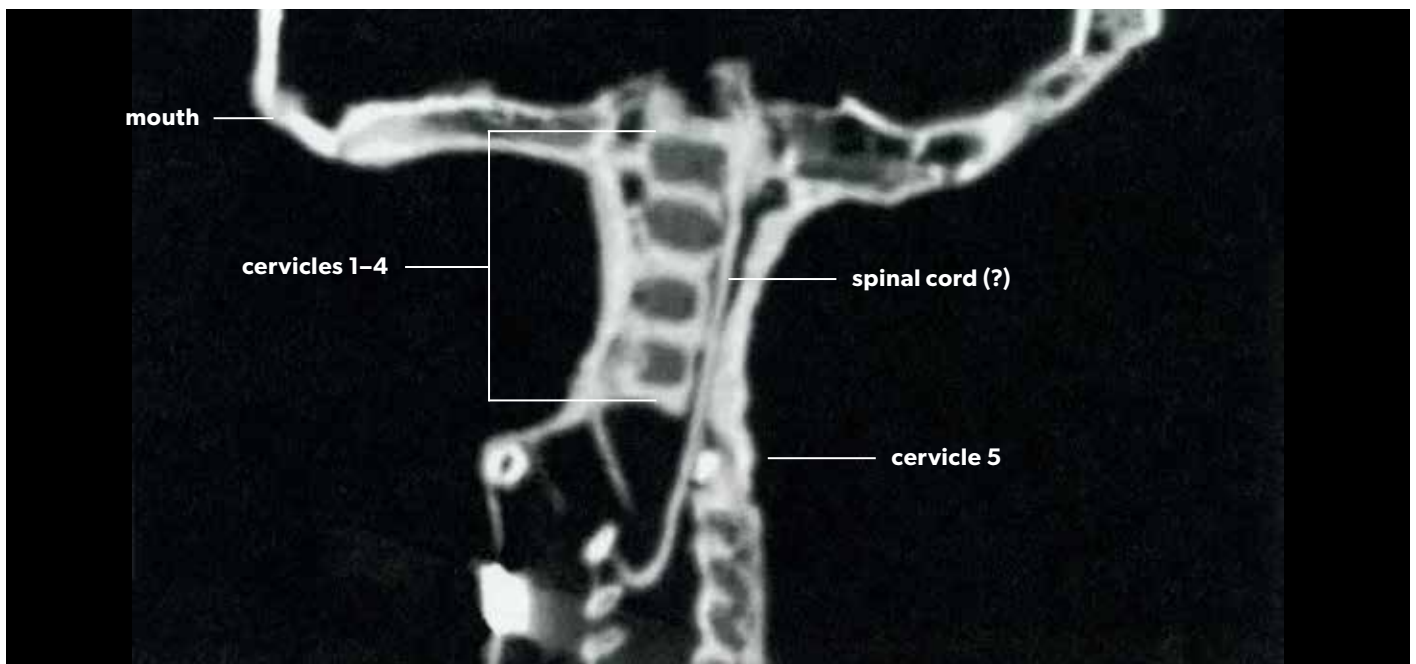

Figure 51. NA-01 Cervicle centra 1–4 (sagittal plane cut).

centra are sections of intervertebral disc cartilage (172–207 HU).

Transverse processes and neural arches are absent. On the posterior surface of the vertebrae is an open neural groove (2 mm x 5.8 mm). In it is a formation resembling a spinal cord (136–176 HU).

Cervicle 5 has no centrum. It has pronounced transverse processes and an open neural arch forming an open neural canal through which spinal fluid passes (fig. 51). In earthly vertebrates spinal fluid passes through a closed neural groove.

In figure 53, two ovals laterally positioned on each side of cervicle 5 can be seen. These are unknown features.

DORSALS

Dorsal vertebrae 1–3: with centra plates (fig. 54).

Dorsal vertebrae 1–5: with well-developed transverse processes (figs. 53 and 55).

Dorsal vertebra 6: absent transverse processes or ribs which is, I believe, unique. (fig. 53).

Dorsal vertebrae 7–15: fully enclosed, horizontal ribs, with transverse processes. (figs. 56 and 64–66).

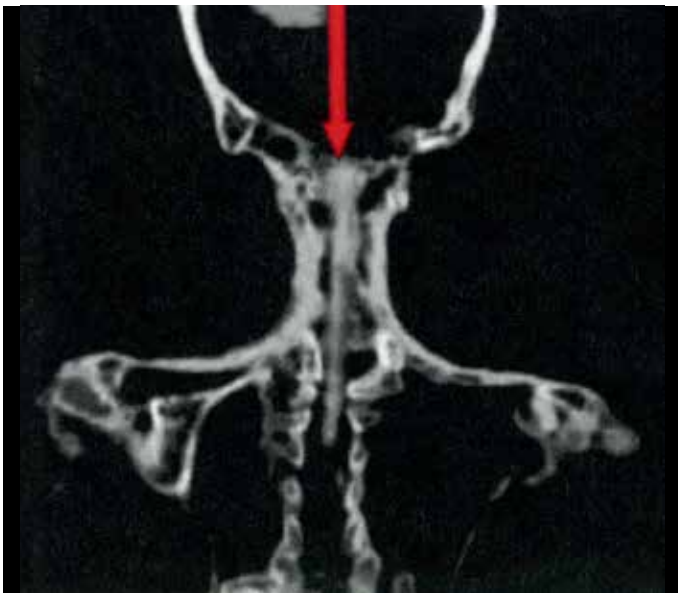

Figure 52. NA-01 spinal cord pathway.

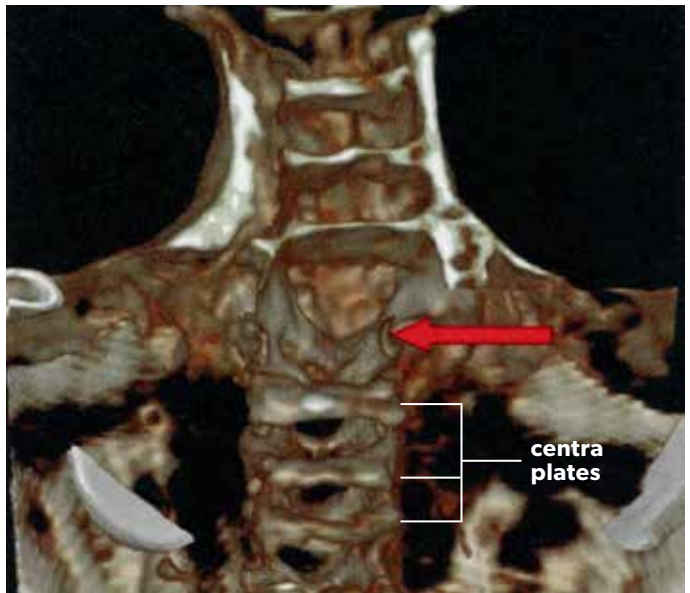

Figure 54. Cervicle 5 position (red arrow) and centra plates.

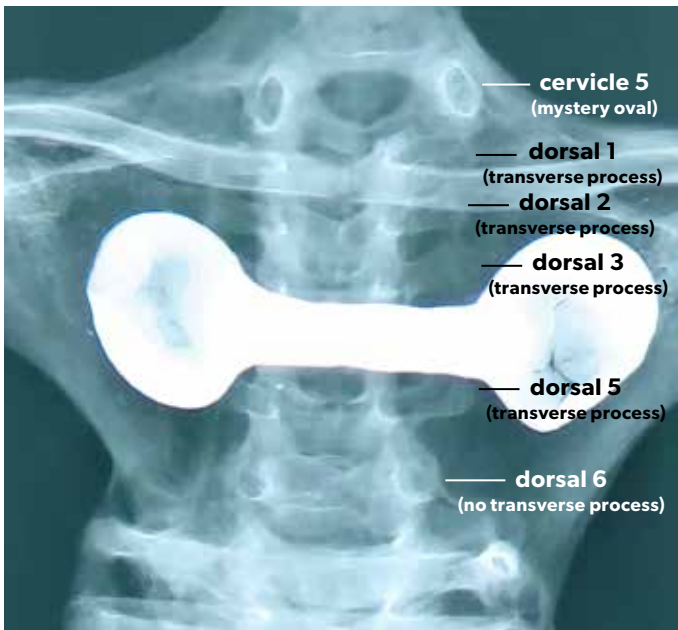

Figure 53. NA-01 transverse processes, anterior view.

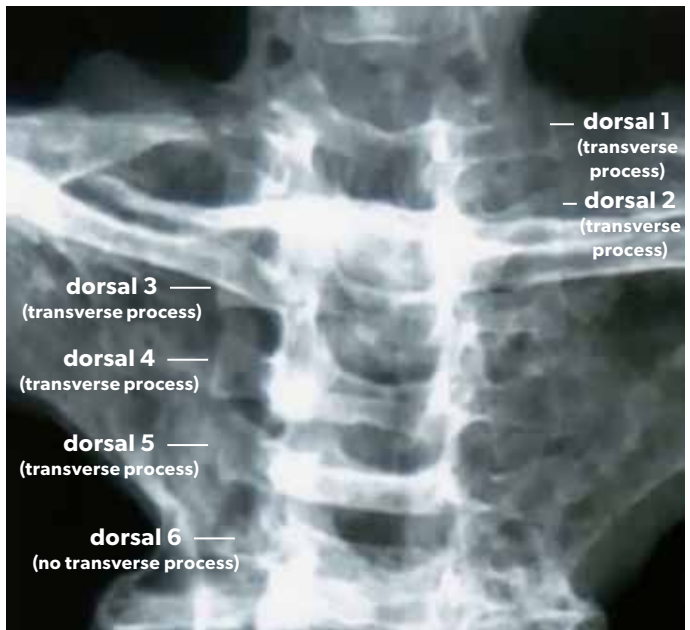

Figure 55. NA-02 transverse processes, anterior view.



Figure 56. NA-01 left side.

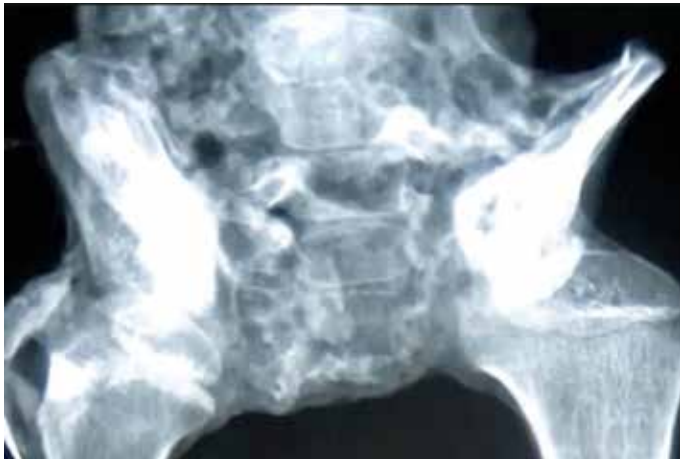

Figure 57. NA-02 Sacrals.

Dorsal vertebrae 16 and 17: typical ribs with one on each side of the centrum (fig. 70).

In the upper dorsal vertebrae, normal centra construction is absent. Instead they are represented by horizontal plates, which I refer to as centra plates (fig. 54). The centra plates are located horizontal to the vertical axis. I have no idea whether this is part of their normal development or whether it is pathological to NA-01. Since there is more than one of these centra plates, I lean toward normal development.

Their pectoral girdle seems over-built for a being of such a small stature. The lack of vertebral centra

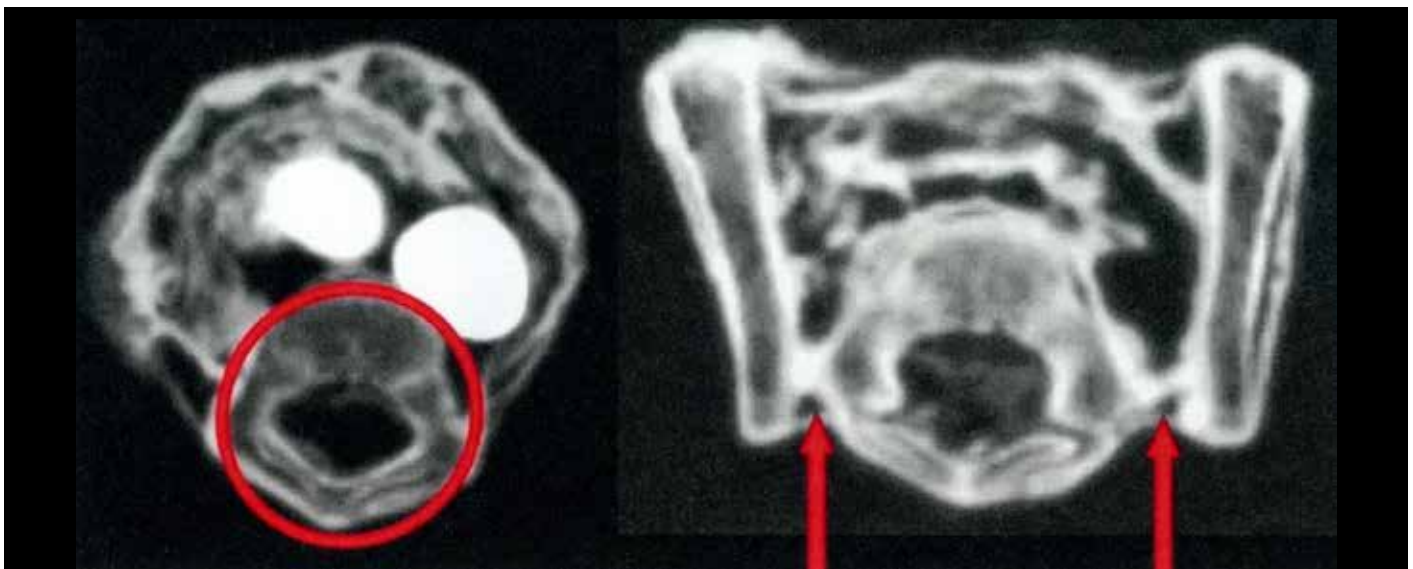

Figure 58. NA-01 large neural canal and sacral ribs.

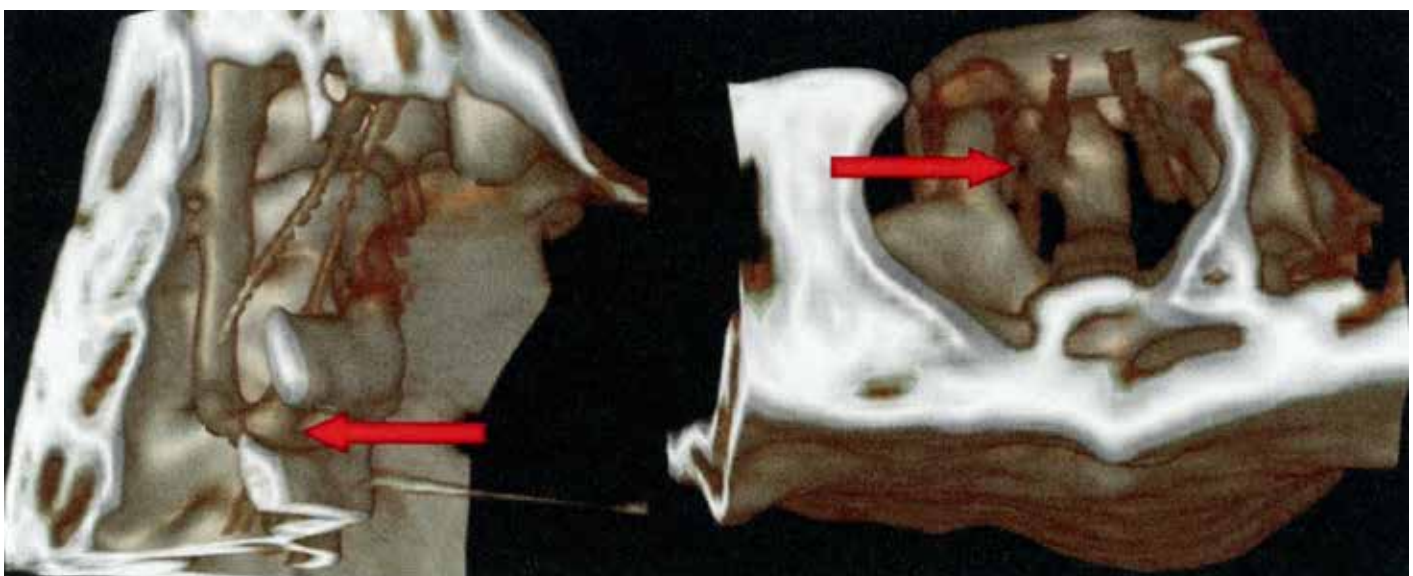

Figure 59. NA-01, two formations merge with the spinal cord. (There is no further explanation of this feature in *The Mummies of Nazca*.)

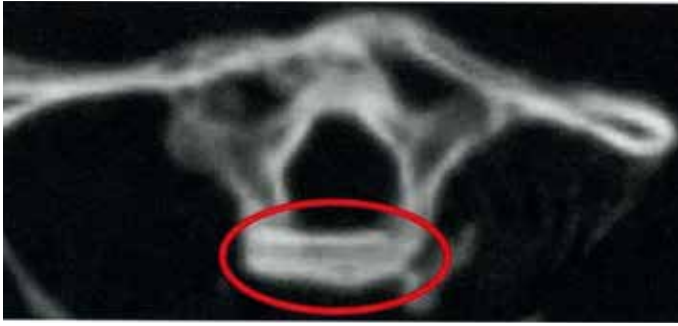

Figure 60. NA-01 dorsal 1 centrum plate with attached neural arch (cross section).

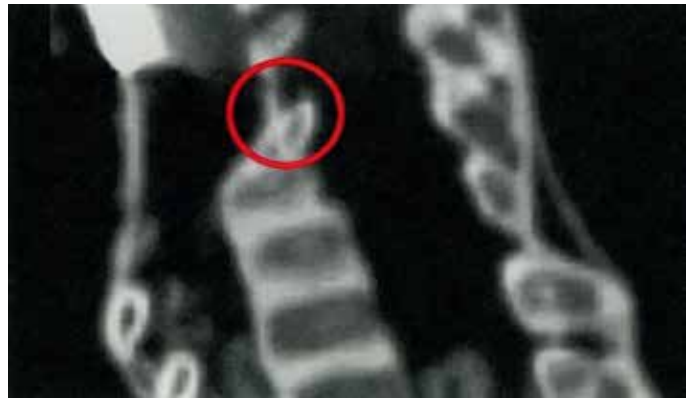

Figure 61. NA-01 centrum of dorsal 5.



Figure 62. NA-01 female left side X-ray (for comparison).



Figure 63. NA-02 male left side X-ray (for comparison).



Figure 64. NA-01 upper section of left side.



Figure 65. NA-01 center section of left side.



Figure 66. NA-01 lower section of left side.



Figure 67. View of overlapping zygapophyses in *Camarasaurus* caudals.

could be the compensating developmental reason for the robust pectoral girdle.

The neural spines for dorsals 1–6 cannot be seen clearly in any of the images available to me. What can be seen is that they are reduced and take a significant jump in length where the ribs begin. You see this same pattern in the X-ray of the male NA-02 (figs. 62 and 63).

Dorsal vertebrae centra 7–17 are slightly larger than the cervicle vertebra centra and retain the typical anatomical shape. The neural groove is large 14.2 x 17.6 mm. Transverse processes are short and directed laterally. To the transverse processes are attached 9 ring-shaped ribs forming the chest.

From dorsal 7 onward the neural spines are developed and teardrop shaped, becoming less so as you move down the vertebral column, where they become more rounded (figs. 64 and 65). The last two dorsal neural spines become more elongated just before the sacrum (fig. 66).

In earthly vertebrates prezygapophyses engage the postzygapophyses on the outside of the preceding vertebrae (fig. 67). That is not the case with *Moultonus dolani*. In this species the prezygapophyses are covered by the neural arch of the preceding vertebra (figs. 65 and 66).

The interior interactions of the neural arches, and postzygapophyses cannot be ascertained without further study. In the X-rays there is no evidence of postzygapophyses such as we are familiar with.

This is seen clearly in the last 10 vertebrae of the vertebral column (fig. 65). To me this is a very elegant design that is amazing and unique.

SACRUM

The sacrum consists of 5 unfused vertebrae (fig. 57), four of which have attached sacral ribs.

In the dorsal cross-section image of the sacral section, one can see that the neural tube takes up a significant part of the centrum. The overall shape of these vertebrae gives just a hint of a neural spine (fig. 58).

SUSPECTED FELINE INJURIES

Two sets of wounds, both approximately 55 mm apart, have been identified (fig. 68). The first wound is between the premaxillary plate and the clavicles. The second is between the fracture of dorsal 10 and the rupture of the intervertebral disc between dorsal 16 and 17. Given these facts, it can be assumed that the injuries were caused by an animal with canine teeth, such as a jaguar.

Between dorsal 15 and 16 there is damage to the intervertebral disc (from 2–4 mm). The linear nature of the disc damage and the fact that the centrum, neural arches, and transverse processes of the vertebra are not damaged, indicate that the impact causing the trauma was likely from the front (fig. 69). The clavicle injury is described in the Clavicles section of this paper.

RIBS

Moultonus dolani has no sternum. Horizontal ribs begin at dorsal 7, and, along with the vertebral column, form the chest, which is cylindrical with apertures (upper and lower) that are approximately equal (fig. 70).

The CT scan and X-ray cross sections (fig. 71) show one very important feature that the previous authors missed. Each section of ribs is composed of 3 parts: short rib, gastralia, short rib. Two short ribs arise laterally and are connected by a gastralia (height 5 mm, width 48 mm–58 mm). Evolutionarily, it is this combination that has allowed the ribs to close up into a single horizontal course, which helps support the overall structure of the abdomen.

In fig. 72 you can see the short side ribs on the right side of *Moultonus dolani*'s rib cage. The ribs are



Figure 68. Left: Injury distance between maxillary plate and the clavicle. Right: Injury distance between dorsals 10 and 16.

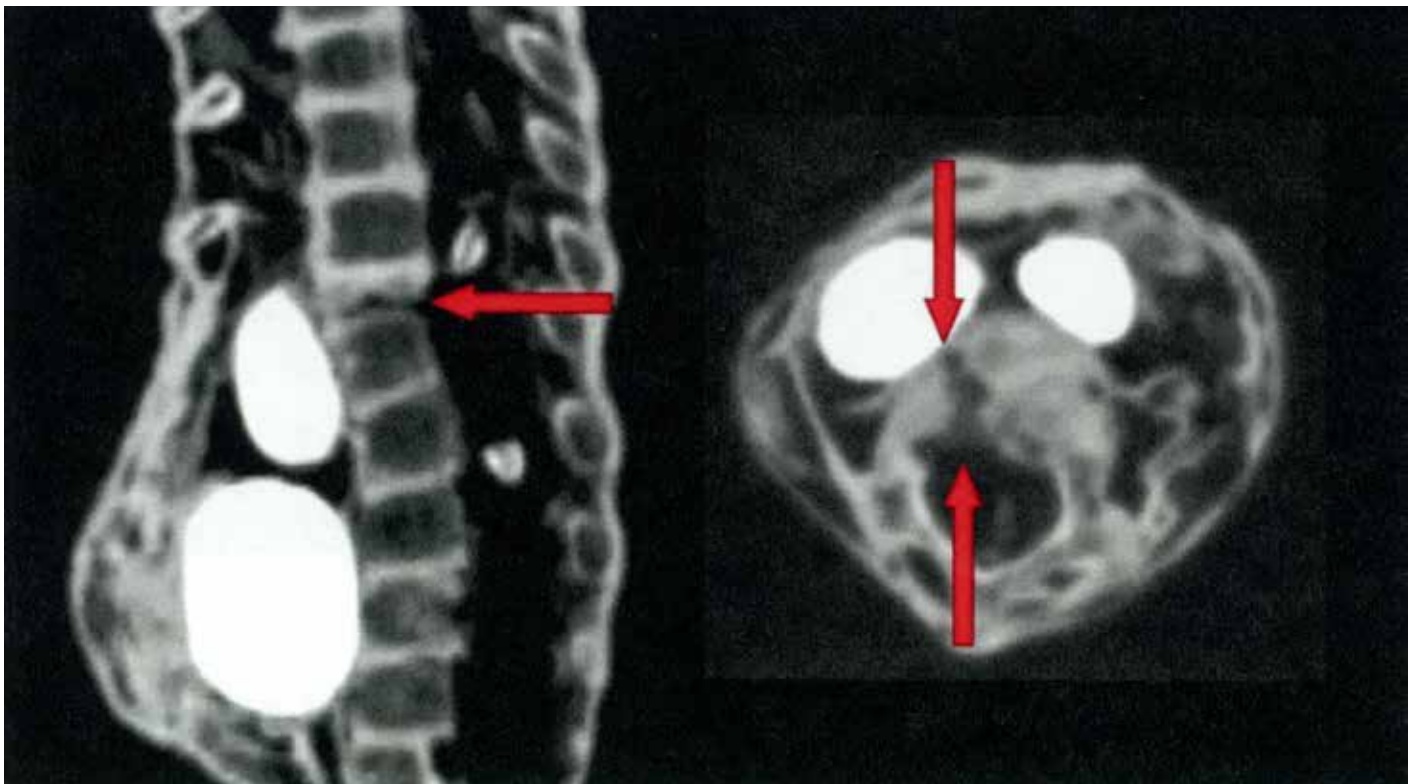

Figure 69. Intervertebral disc damage marked by red arrows.



Figure 70. NA-01 gastralia. Note that the rib cage is horizontal. The ovals on each side are articulation points with the side ribs.

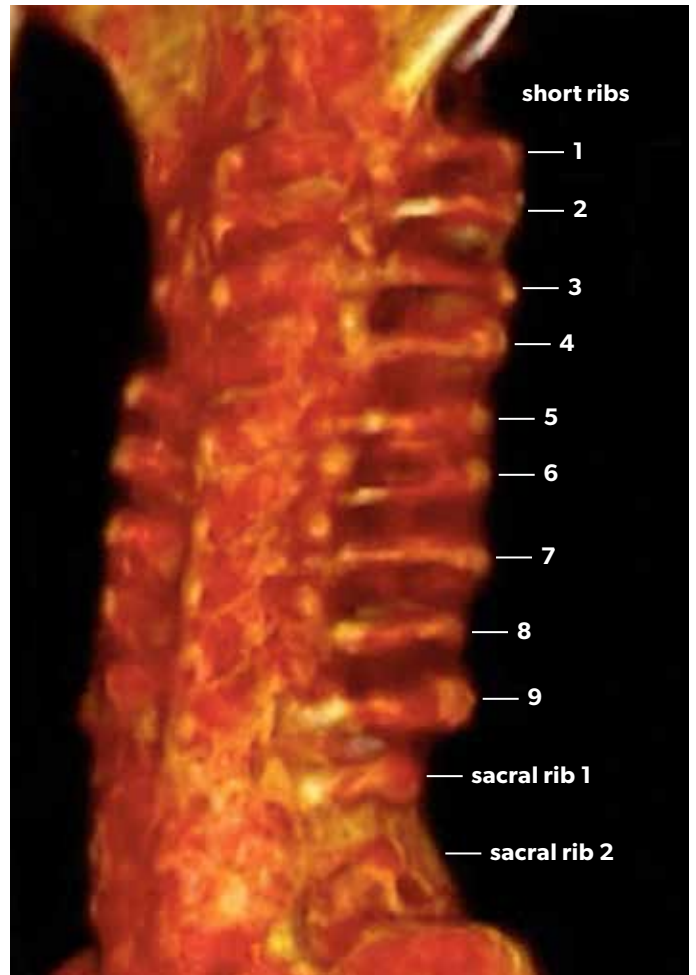

Figure 72. NA-01 posterior right view of short and sacral ribs.

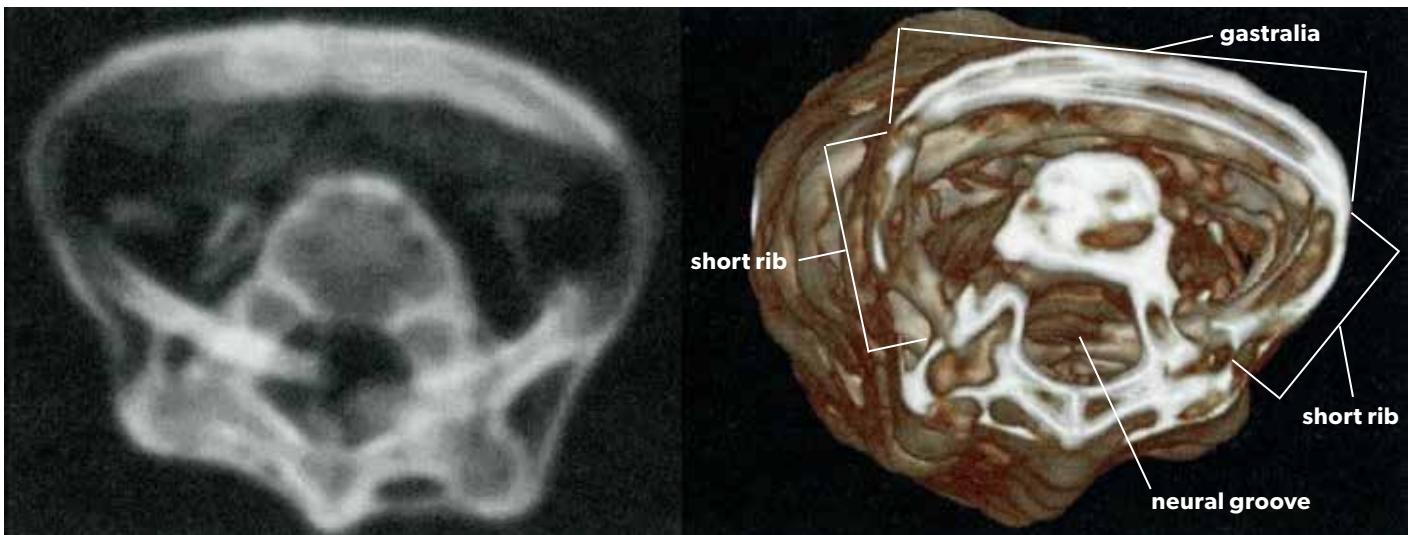

Figure 71. NA-01 ribs cross section. Left: X-ray; right: CT scan

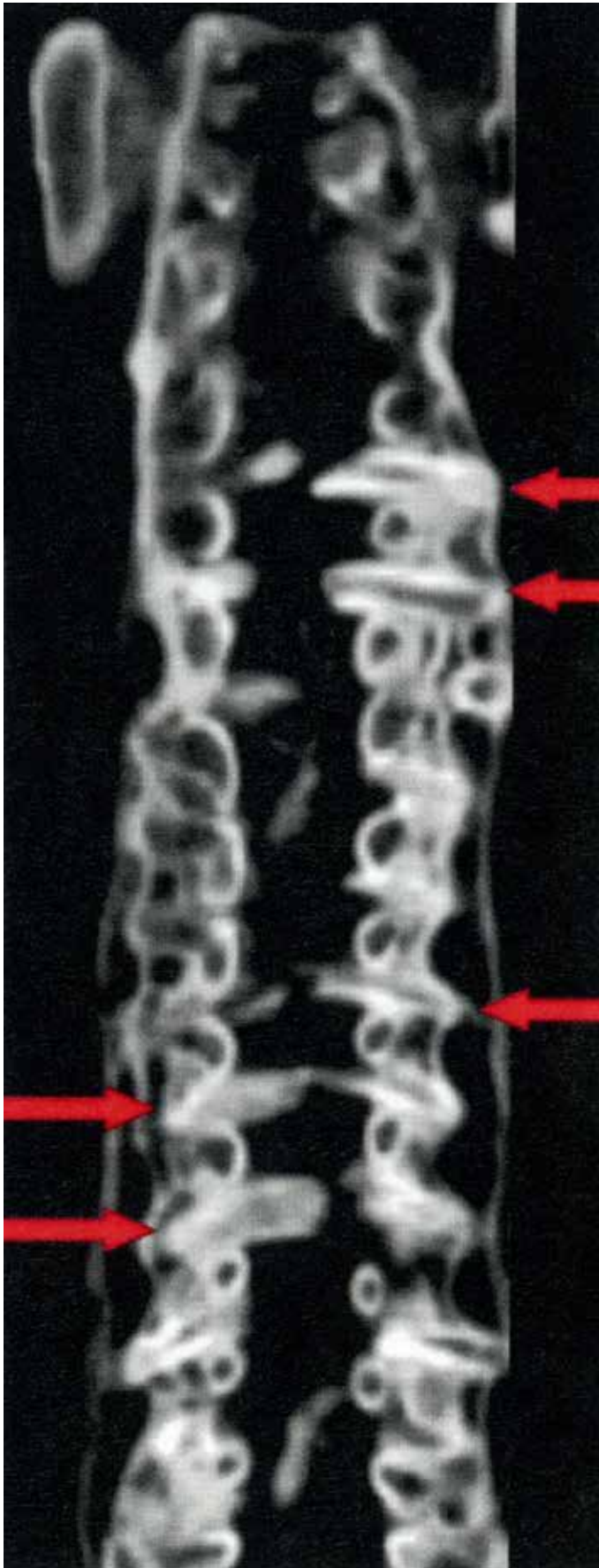

Figure 73. Broken rib fragments in the intervertebral foramina. The edges of the fragments are seen in the spinal canal (lateral view).

composed of bone only, lacking cartilage. Many of the ribs are broken and separated from their attachment points. They shifted into the intervertebral spaces. The edges of the fragments are seen in the spinal canal (fig. 73).

Gastralia are found in theropod and prosauropod dinosaurs, pterosaurs, plesiosaurs, choristoderes, and some primitive pelycosaurs. Gastralia are also known to be present in primitive ornithischian and sauropodomorph dinosaurs. The gastralia present in this species points to a saurian origin.

CLAVICLES

In humans the clavicles articulate to the manubrium of the sternum forming sternoclavicular joints. *Moultonus dolani*'s species lacks a sternum, so their clavicles articulate to each other at the midline of the chest forming a unique joint. The clavicles expand medially much more than in humans. This forms a robust triangular shaped joint that is flattened on the anterior surface. This is seen in the N-05 body (fig. 75). The clavicles have a dorsal bow to them just past the halfway point. The lateral ends form the acromioclavicular joint.

NA-01 has broken clavicles and a metal plate (6.4 cm wide x 0.4 cm thick x 1.2 cm high) (fig. 74). Cervicle 5 and the fracture of the clavicles are in the same plane, and it seems that after the injury in this area there was a loss of what, in us, would be the sternoclavicular joint. Possibly the injury to the clavicles also resulted in the loss of the centrum of cervicle 5 (fig. 51).

The metal plate in the center of the chest has a density of 8223 HU (fig. 74). It can be seen in all chest views of the NA-01 body. The device follows the curve of the chest and is bilaterally symmetrical. The clavicles of the other 5 individuals protrude at an angle and their joints converge at the midline of the chest (fig. 75). I believe we can assume that the surgery to remove the damaged articular parts of the clavicles reduced the total length of NA-01's clavicles, and the metal plate was applied to hold the shape of the chest cavity.

On some of the other individuals metal objects are found in the tissues. This fact indicates that members of *Moultonus dolani*'s species carried out these medical procedures.



Figure 74. NA-01 Broken clavicle.

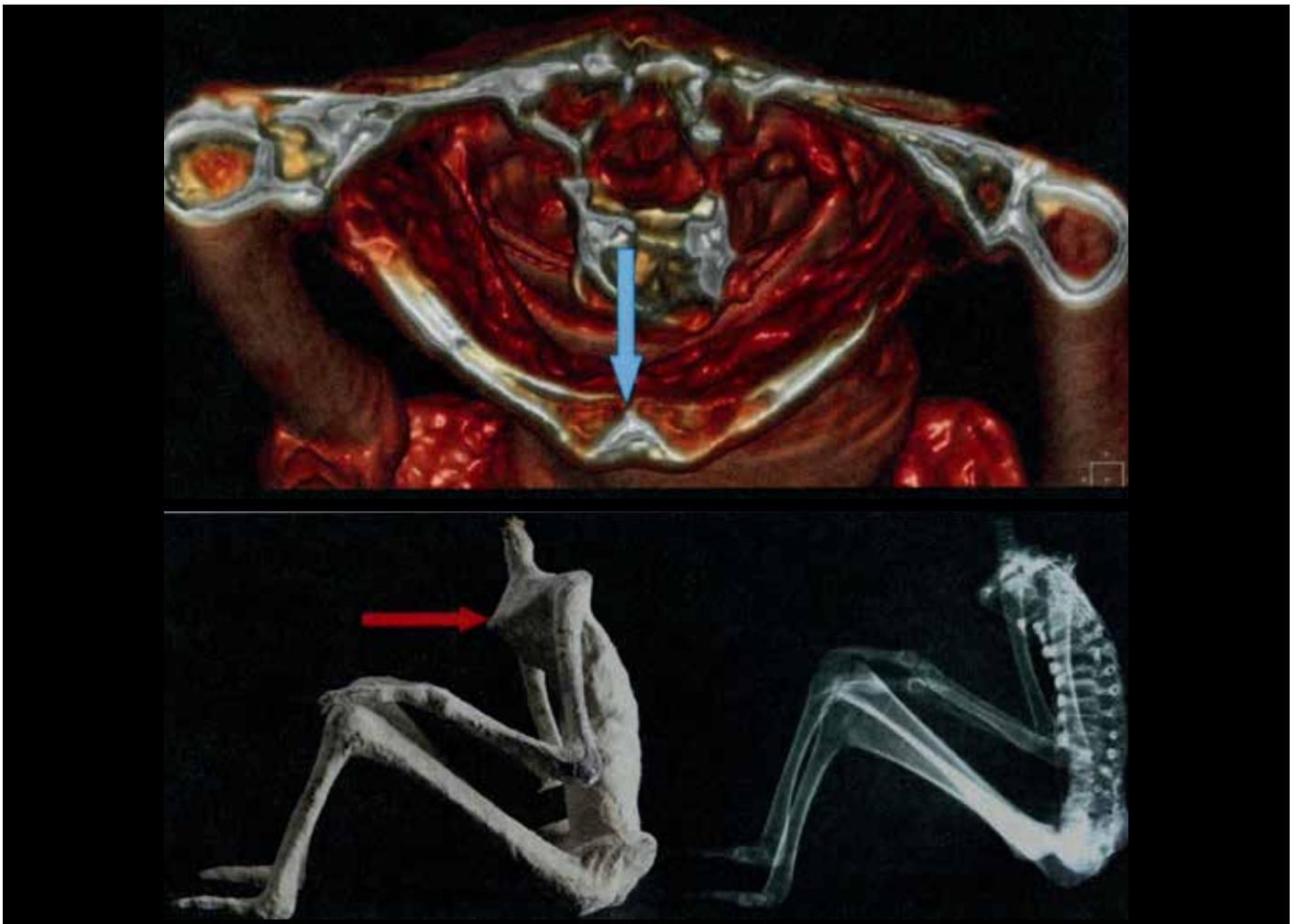

Figure 75. NA-05 showing the articulation of the clavicles (blue and red arrows).

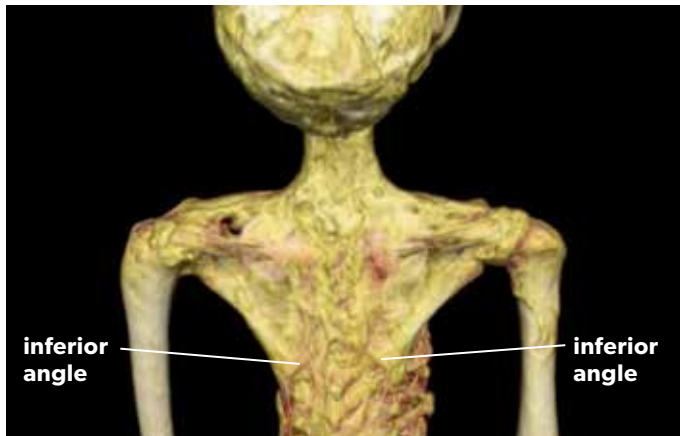

Figure 76. NA-01 inferior angle of the scapula, posterior view.

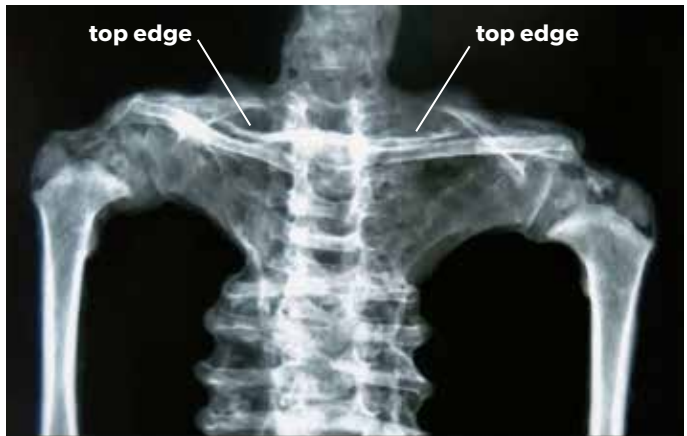

Figure 78. NA-02, anterior view, top edge of scapula and head of humerus.

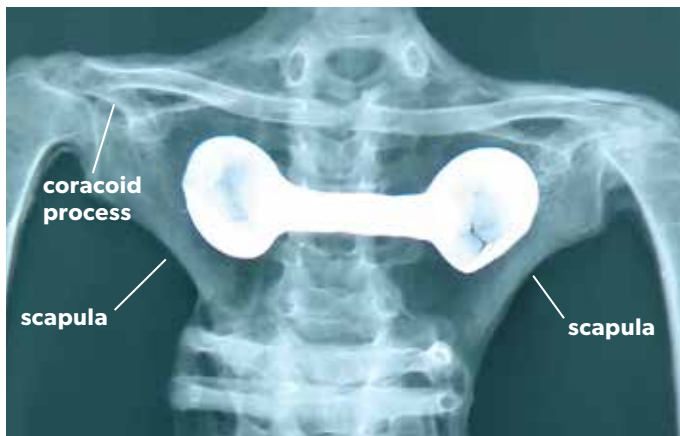

Figure 77. NA-01 anterior view, scapula and head of humerus.



Figure 79. NA-01 Left: Posterior view, right acromion process. Right: Anterior view, connection of the right clavicle.

SCAPULA

In the upper extremities, both scapula are positioned similarly to those in human anatomy. They have a wing-shaped form and nonpronounced spines. The spine of scapula comes off at an angle that is more horizontal than humans' (fig. 76). The inferior angle of the scapula is more squared off than ours, as well as being at a completely different angle (figs. 76 and 79). The lateral border is easily discernable (figs. 77 and 78), and the coracoid process is clearly seen (fig. 77).

In humans the acromion process extends from the top of the spine of the scapula towards the front of the body. It functions to stabilize the shoulder joint and is attached by ligaments to the clavicle and coracoid process of the scapula. The deltoid muscle also attaches to the acromion process, which allows a person to abduct their arms.

In *Moultonus dolani* the acromion is built much the same way as in humans, with the addition of an extension, the acromion hook. When viewed posteriorly the acromion hook comes down and extends into the shoulder joint at the margin of where the humerus joins the shoulder, strengthening the glenoid cavity by providing increased contact surface (fig. 79).

A hook-shaped process on the posterior surface of the scapula was pointed out in fig. 3.90, page 214, of *Mysterious Mummies of Nazca*. There was no discussion that I could find. I believe it is unique for scapula anatomy, so I am naming it the Korotkov process after the man who authored the book, Dr. Konstantin Korotkov (figs. 80 and 81).

The Korotkov process is seated on the scapula, a little behind the shoulder and a little bit off the blade of the scapula. It rises up to meet part of



Figure 80. NA-01 left posterior view, Korotkov process.

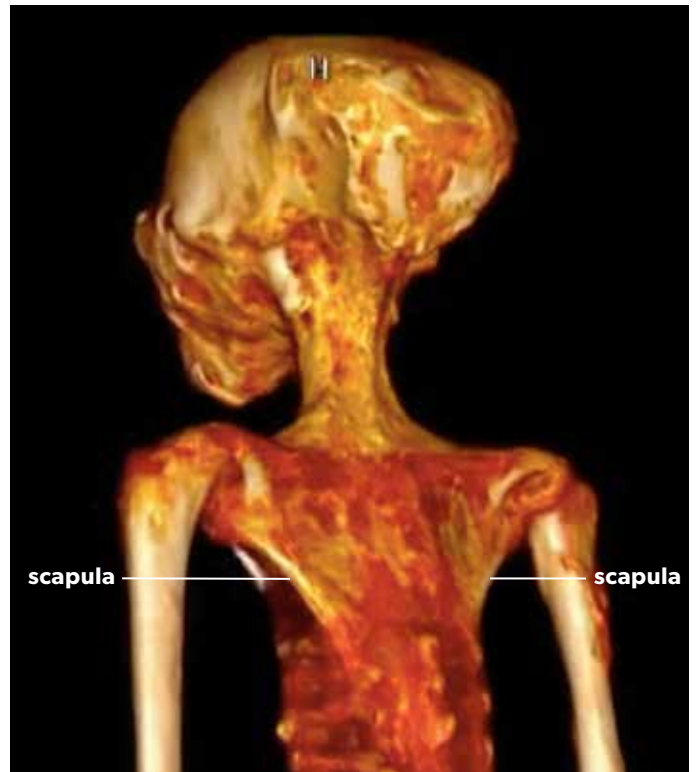

Figure 82. NA-01 posterior view of the scapula.

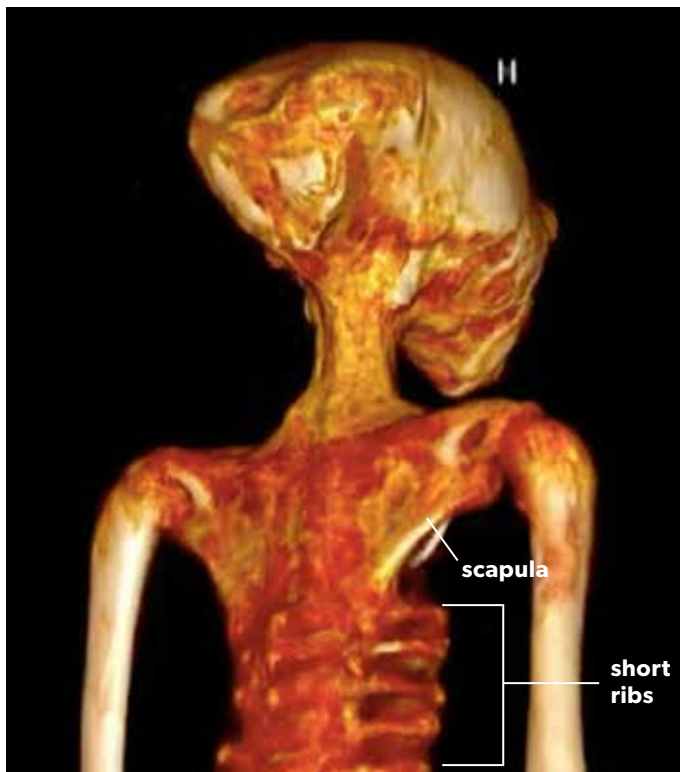

Figure 81. NA-01 posterior right view of scapula and short ribs.



Figure 83. NA-01 anterior view, lateral boarder, and subscapularis. This is the only view that gives any hint of the features on the anterior surface of the scapula.

the humerus and likely provides additional joint stabilization.

The lateral border of the scapula is easily discernable. The subscapularis is the V-shaped groove on the lateral edge. It gets wider in the dorsal direction (fig. 83).

LIMBS

The long bones of this species are of a much simpler construction, lacking many of the features that are found in human skeletons. They have a single bone in place of the ulna and radius and have only a tibia with no fibula. They have unique joints as well.

HUMERUS

The shape of the articular cavity for the humerus is more elongated (10 mm x 25 mm) than in humans. The articular surface is spherical. The humerus has been drawn to the upper edge of the joint and the acromion process due to the shortening of the tendons of the muscles during dehydration. The shape of the head and the position of the humerus can be seen in figures 77 and 78.



Figure 84. NA-01. Note the differing features of the humeri.

The humerus bones are long and consist of a body and two epiphyses. Humerus lengths: 11.9 cm right, 12.6 cm left. Thickness at the center of the shaft: 10.6 mm right, 9.2 mm left. The proximal epiphysis of the humerus is gracile and has a beak-shaped head. The articular surface is turned inside and up to meet the glenoid cavity (fig. 78).

NA-02 clearly has a more robust humerus than NA-01. His humerus has a more ball-and-socket appearance to it—more like what we see in our femur construction. These differences may be an aspect of sexual dimorphism (fig. 78).

I believe that NA-01 is an older individual based on the fact the dorsal growth plates are absent in her humerus (fig. 77). The epiphysis of NA-02's humerus is clearly visible, so he was still growing when he died (fig. 78).



Figure 85. NA-01. Both humeri can be seen.

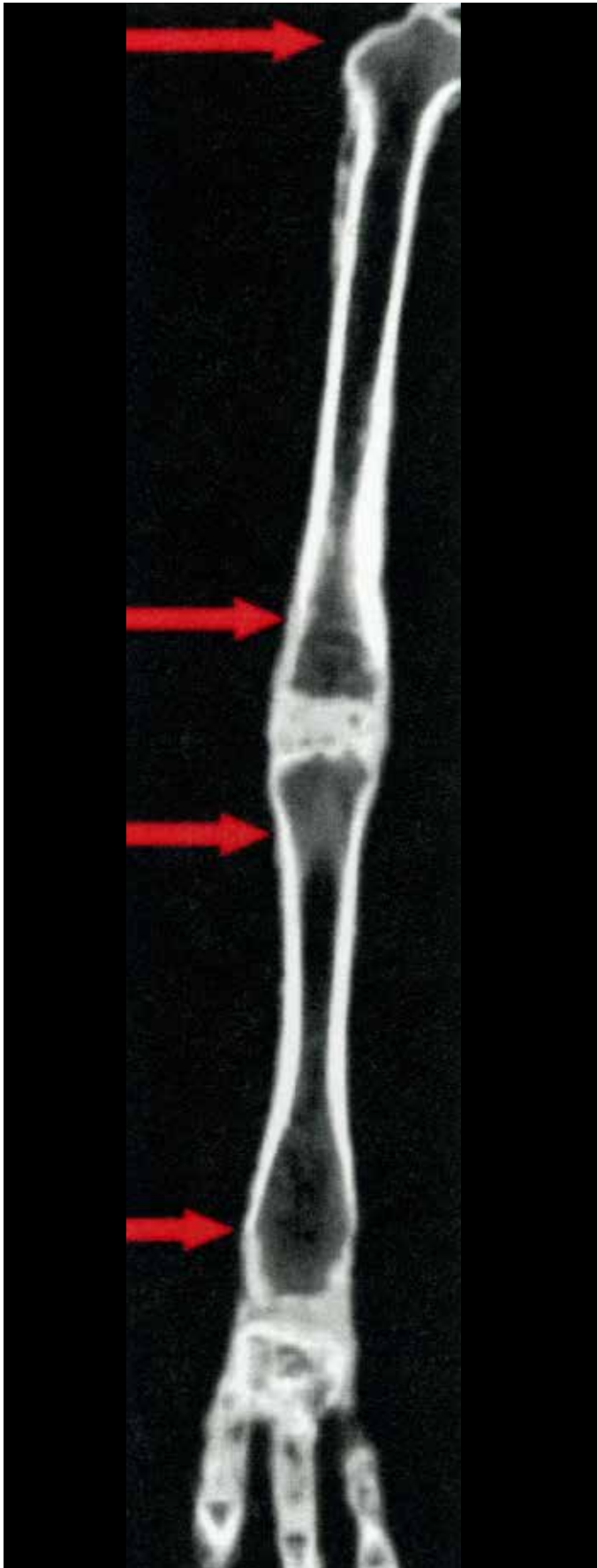

Figure 86. NA-01 right arm including a view of the epiphyses of the humerus and forearm; spongy substance is visible.



Figure 87. NA-01 right and left elbow joint. Cylinders are indicated by an arrow.



Figure 88. NA-01 ulnius.



Figure 89. NA-02 ulnius.

In NA-01 the left and right humeri are shaped differently. In the X-ray (fig. 84) it appears that the distal end of the left humerus is pathological in some manner because it is less expanded than the right. Alternatively, different sizes of the bones on the right and on the left might be explained in terms of physiology by the activity imposed upon them.

Cortical bone is the dense outer surface of bone that forms a protective layer around the internal



Figure 90. NA-01 left ulnius.

cavity. In humans this type of bone, also known as compact bone, makes up nearly 80 percent of skeletal mass and is imperative to body structure and weight bearing because of its high resistance to bending and torsion.

In the X-rays of the right distal epiphysis of the humerus we see the absence of cortical bone, from the lateral and medial side to a height of 22 mm, and the splitting of the right distal epiphysis by 8 mm. In the left distal epiphysis of the humerus these distances are 9.4 mm and 4.5 mm respectively (fig. 84). The distal epiphysis of the left humerus is flattened in the anterior-posterior direction. My theory is that cortical bone is not as critical for such a small species of beings.

The articular surfaces do not interact with each other. This is a fundamental difference of this type of joint from the joints of humans or any other vertebrate species (fig. 87).

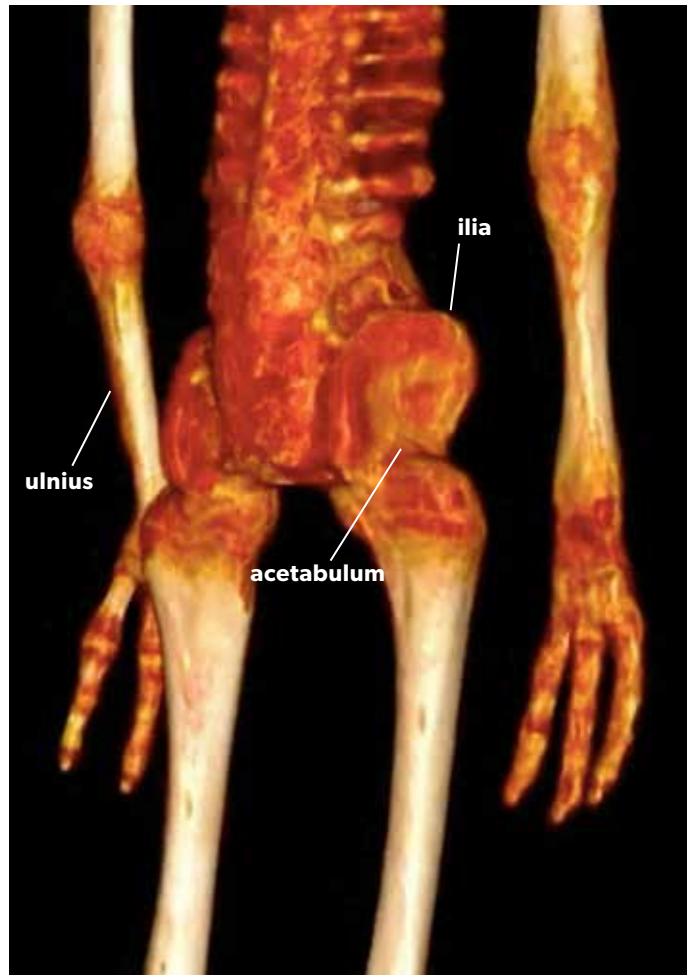

Figure 91. NA-01 posterior view; CT scan of ulnius and hands.

The peculiarities of the anatomy of the “elbow joint” include the presence of bony protuberances in the form of a crown at the ends of the humerus, and the “elbow” bone has a convex surface. The elbow joint consists of several cavities (fig. 87).

The forearms of this species consist of one bone that I am designating the ulnius. All existing earthly species of vertebrates have two forearm bones—the ulna and radius. This also holds true for all of the fossil record. This is the primary reason that *Moultonus dolani* can be identified as an alien being. It did not evolve on this planet.

The ulnius consists of the shaft and two epiphyses—proximal and distal. In the proximal and distal areas, the bones are thickened and flattened in the anterior-posterior direction. The right ulnius is 9.3 cm long and the left is 8.1 cm, with a thickness of 10.3 mm in the center of the shaft. In the proximal and distal ends of the ulnius, there are trabeculae with a bone marrow residue.

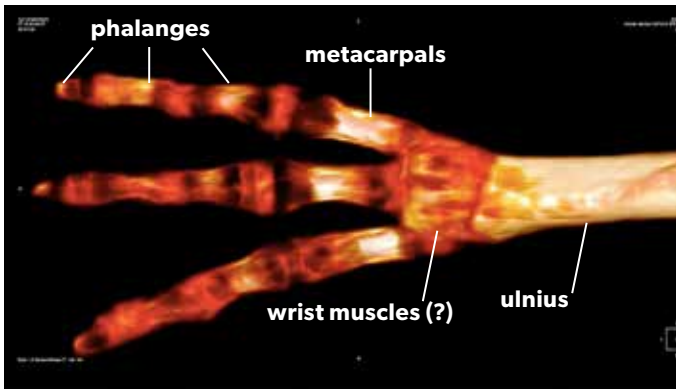

Figure 92. NA-01 CT scan of left hand (6.5 cm). Note the muscles (or possibly tendons) over the single carpal.

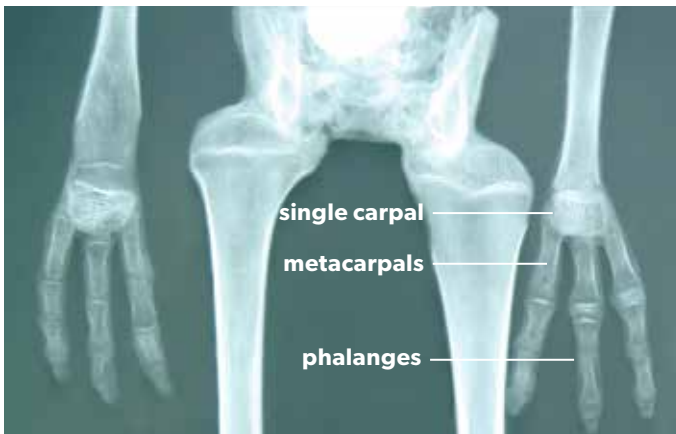

Figure 93. NA-01 hands.

In figures 90 and 91 you can see that there is no trace of another bone associated with the ulnius. All directional views for this bone are available.

HANDS

The hand consists of a wrist with a single robust carpal, three metacarpals, and three phalanges each with three digits. The palm is absent, and the three metacarpals are extensions of the fingers, giving each finger 4 digits for movement. This very likely compensates for their lack of an opposable thumb (figs. 92–94).

The single carpal is trapezoidal in shape—13 mm high, 16 mm wide, with trabecula inside (fig. 90).

In figure 95, upper left, you can see the form of the wrist with a visible septum. On the upper right shows the shape of the articular surface of the metacarpal of the heel. The red arrow points to the subulate process (slender pointing to a tip)

The bottom of figure 95 show the angles between the articular surface and the axis of the bones of the metacarpal.

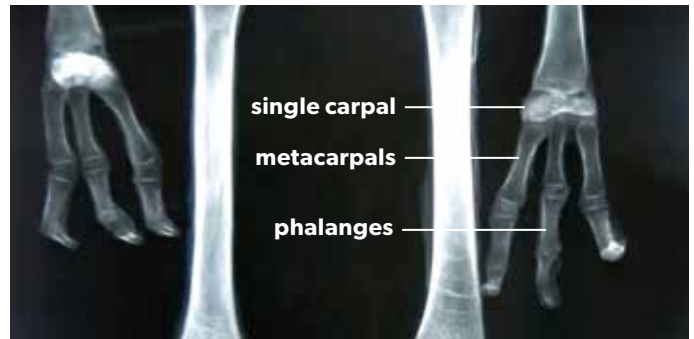

Figure 94. NA-02 hands.



Figure 95. NA-01 metacarpals.

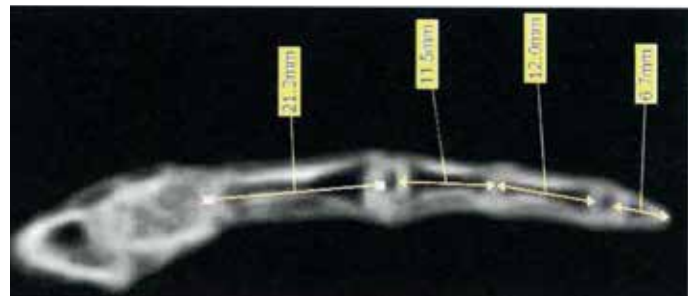

Figure 96. metacarpal and phalanges measurements

At the base of the outer bones of the metacarpus, the subulate process is seen from the outside, which resembles the shape of the articular surface of the #3 metacarpal bone. The size is about 21 mm. The interface is not perpendicular to the axis of the body of the metacarpal bone, but at an angle of 136 degrees. (fig. 95). The dorsal and palmar interosseous muscles are missing where they are normally located in our metacarpals. This makes sense with regards to finger movement because their metacarpals are open providing additional finger length. They can't be missing so the dorsal and palmar interosseous muscles must be located in the wrist (fig. 92).



Figure 97. NA-01 pelvis anterior view. The analog of the epiphyseal line is the line from the fusion of the spongy substance of the epiphysis and the cartilage of the tubular bone.



Figure 98. Ventral view.



Figure 99. NA-01. Ligaments of the ilium junction and the end of the vertebral canal of the sacrum; the relationship of the ilium wing and femoral head.

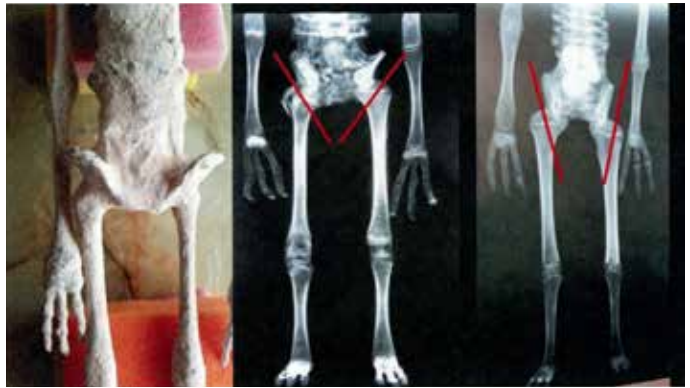

Figure 100. The difference in the angle of the wings of the iliac bones for NA-02 and NA-01.

Measurements of the metacarpals and phalanges range from 12–7 mm. The structure of the phalanges corresponds to our human anatomy. The joints of the fingers are adjoint (fig. 96).

ILIA

The ilia sit on the heads of the femurs, rather than having insertion points, and cover a large percentage of the femur heads dorsally. This is odd compared to earthly vertebrate species (figs. 91 and 98).

Ilia are near perfect ovals. There is a shallow lateral curve to the ilium (fig. 97). Acetabulum is present (fig. 91), and sacral ribs are attached (fig. 58). A pelvic girdle is absent; there are no pubis or ischia.

The iliac bones are fixed to the sacral bone through several ligaments (136–212 HU). The coccygeal part is absent, and the vertebral canal in the lower part is covered by skin (fig. 99).

In the analysis of the ilia bones of the various NA individuals we can see a wide divergence of the wings of the ilia. In the NA-01 female they are positioned almost vertically. In the NA-02 male they are more V-shaped (fig. 100).

NA-01 has a cloaca fissure like our reptiles (fig. 97). [Statement by Jose de la Cruz Rios, in one of the documentaries.]

FEMURS AND TIBIA

The femurs each measure approximately 15 cm long in NA-01. It is difficult to determine the extent of the distal end. The femur consists of a shaft and two epiphyses. The body of the bone is bent anteriorly (fig. 102). The proximal epiphysis has the form of a hemisphere. The proximal epiphysis of the femur

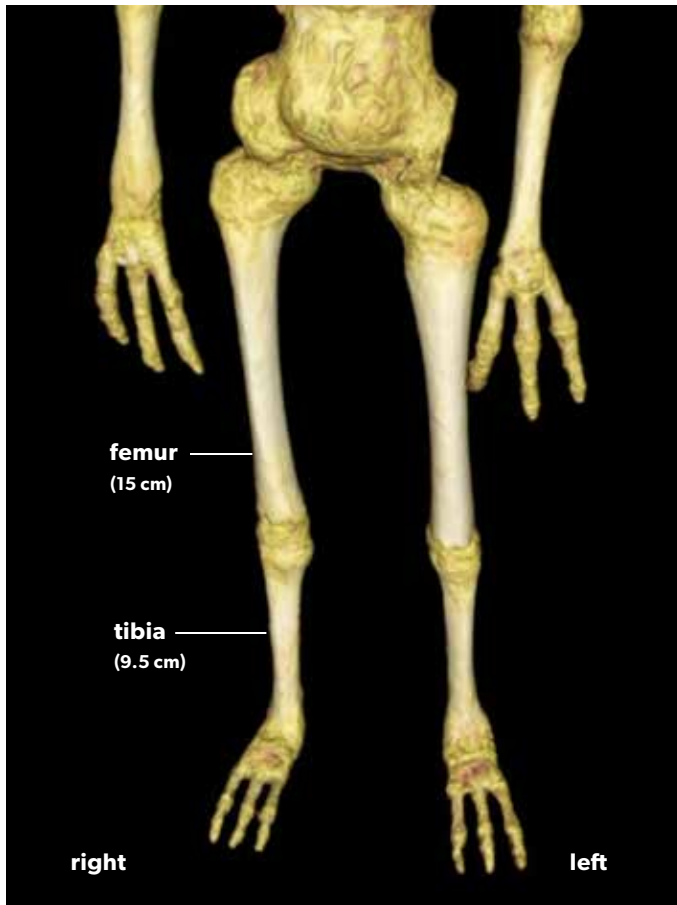

Figure 101. NA-01 femurs.

consists of two fused parts. There is a spongy substance of the epiphysis and the epiphyseal cartilage of the tubular shaft, between which is the analog of the epiphyseal line (fig. 97).

They have a shallow insertion of the femur head, and the femurs are wider than the ilia. Our hips are the same width as our legs. This is not the case here (fig. 101).

The knee joint itself is represented by several cavity cylinders. The articular surfaces appear to move due to change in volume in the cylinders. This is a fundamental difference compared to human limb joints (fig. 105).

The most distinctive part of the femur is in the distal epiphysis. It is expanded laterally ever so slightly and considerably more in the male (fig. 106). It ends with crown-shaped outgrowths (fig. 107).

The lower limb is represented by only one bone—the tibia. The fibula is absent. The tibiae are 9.5 cm long in NA-01, and, again, it is difficult to get a good measurement from the CT scans.



Figure 102. Na-01 femur bent anteriorly.



Figure 103. NA-01 anterior view of femurs.



Figure 104. NA-01 posterior view of femurs.



Figure 105. NA-01 knee joints.



Figure 108. NA-01 tibiae.



Figure 106. NA-02 knee joints.



Figure 109. NA-02 tibiae.



Figure 107. NA-01. Growths in the form of a crown on the distal epiphysis of the femur bone.

The tibiae consists of a shaft and two epiphyses. The shaft of the tibia is long and oval in cross-section. The proximal epiphysis of the tibia has the form of a hemisphere, the distal epiphysis is thickened and widened in the transverse direction. It ends with two outgrowths-condyles representing a heel (figs. 108 and 109).



Figure 110. NA-01 distal end of tibia and a foot. The distal epiphysis of the tibia ends with two outgrowths (condyles) representing the heel of the foot.

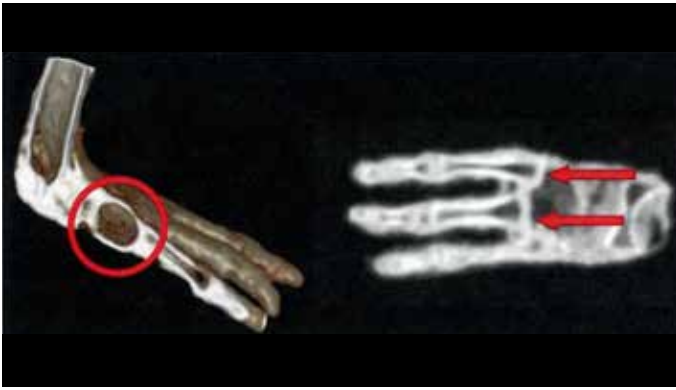

Figure 111. NA-01 foot. Left: An oval cavity is in the center of the foot. Right: The shape of the articular surfaces of the proximal phalanges.

FEET

The feet lack any kind of ankle construction like we are used to. Ankle bones are absent. The three metatarsals are absent. They have three phalanges each with three digits.

The foot is formed at the distal epiphysis of the tibia. Between the distal epiphysis of the tibia is a small outgrowth of bone. There is a layer of connective tissue, which plays the role of the joint for the heel (fig. 110). On the posterior surface of the foot there is a bulge forming a soft tissue heel (fig. 111).

In the center of the single bones of the tarsus is an oval cavity (20 x 12 mm), presumably formed of bone marrow. The bones of the metatarsus are absent. Toes are represented by 3 phalanges—sizes ranging from 20 mm for the proximal phalanges down to 7 mm for the distal.

The articular surfaces of the proximal phalanx is perpendicular to the axis of the body. The joints of the toes are paired (fig. 111).

X-rays and CT scans of the feet are very poor. Additional information and more study is needed to better resolve the feet.

INTERNAL ORGANS:

There is a structure that has been identified as the aorta, which in humans is the main artery supplying oxygenated blood to the circulatory system. In humans the aorta passes over the heart from the left ventricle and runs in front of the backbone.

In *Moultonus dolani* it is on right side of the body which is the opposite of humans. It is the only structure that can be identified as any kind of a heart. When all the study is concluded I believe it will be labeled as an aortic heart for two reasons: One is its tremendous size in relation to the body,

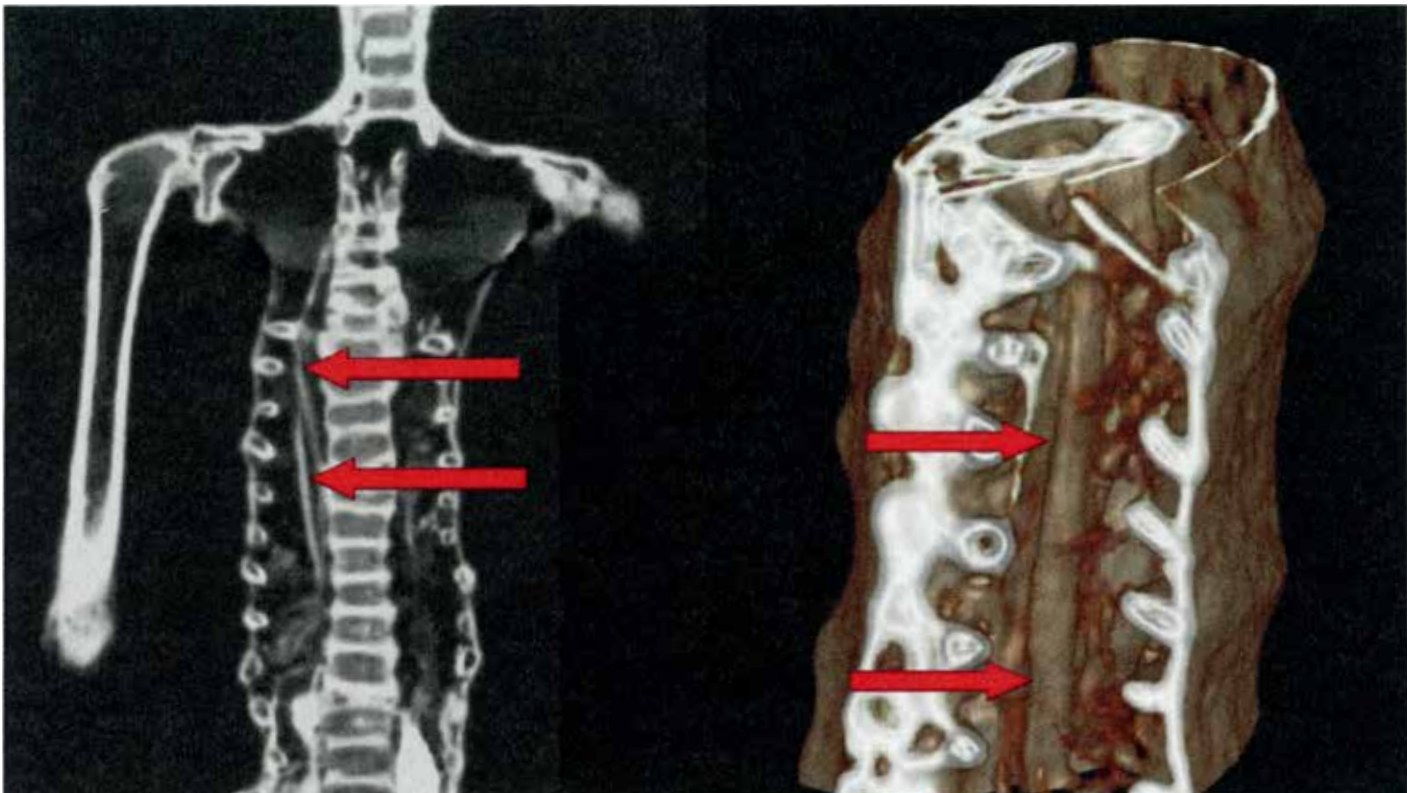

Figure 112. NA-01 aortic heart (?).



Figure 113. NA-01 aortic heart (?).

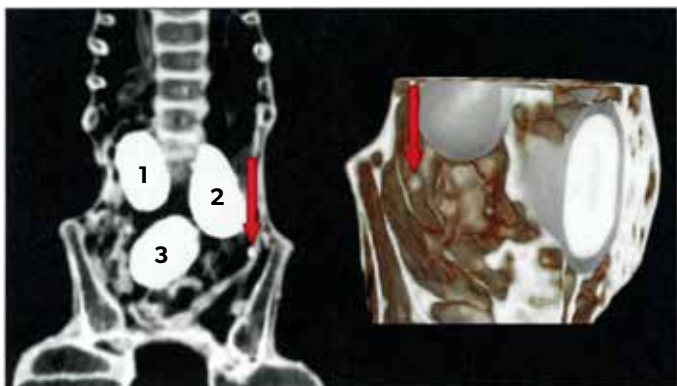

Figure 114. NA-01 egg in the fallopian tube

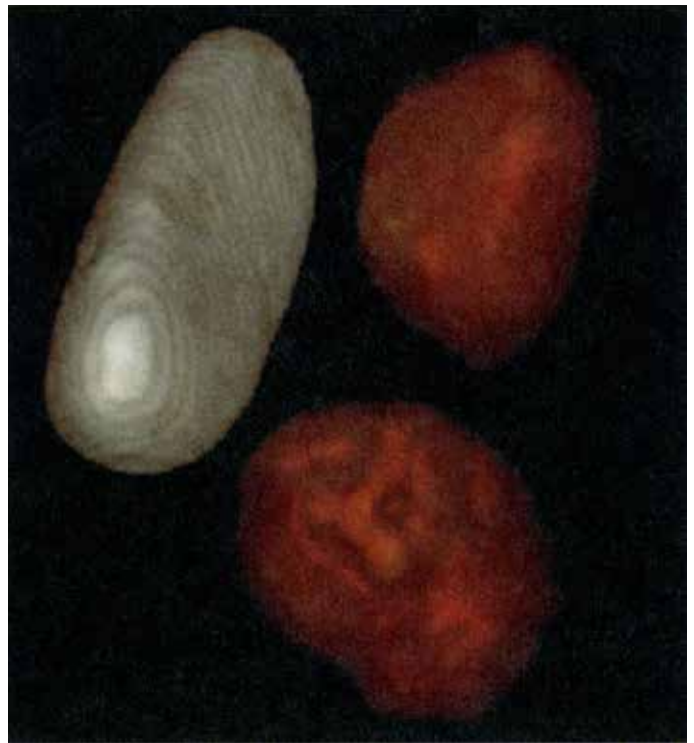

Figure 115. Computer enhanced eggs .

and the other is that it is the only organ identified as a possible heart (figs. 112 and 113).

THE EGGS

The holotype female has three eggs preserved within her pelvic cavity. Each is a different size. I don't think it is a preservation issue related to death and burial. The eggs look complete and uncrushed. They have the following measurements (*The Mummies of Nazca*, p. 57):

#1 is 2.3 x 1.3 x 2.6 cm

#2 is 1.9 x 1.6 x 3.1 cm

#3 is 2.7 x 1.9 x 2.3 cm

The density of the eggs is (1926–2016 HU), which is denser than the cortical plate of bones and calcinates. (The density of oxalates and kidney stones is no more than 1518 HU.)

The tissues of the organs surrounding the eggs have a tight contact with them in some places, which can indicate alimentation of these formations and gradual development (figs. 113 and 114).

In the pelvic area on the left side rises a narrow structure resembling a fallopian (1.7 mm in diameter). Within can be seen an egg (fig. 114).

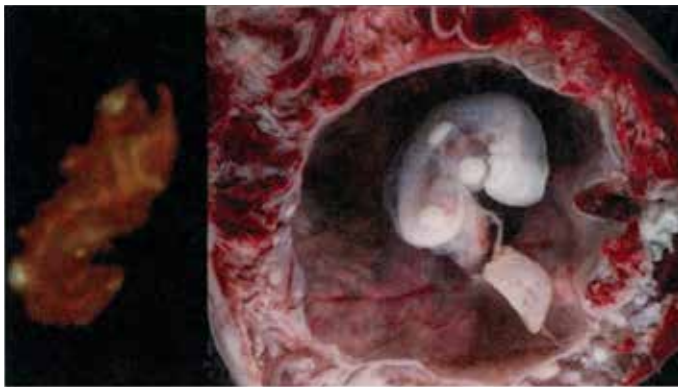

Figure 116. The content of the vertical egg and a human embryo of 8 weeks.

Dr. Dmitrii V. Galetckii determined that the eggs contain embryos. Changes in the density show structural irregularity. Using CT scans to change the structural density of the tissues—removing and rotating the image—we come to the contents of the eggs. This is interpreted as an egg with an embryo of 8 weeks (assuming that we share similar growth rates) (figs. 115 and 116).

We can only guess as to their reproductive patterns. I would like to suggest that the three eggs are in different stages of development based on their different sizes. The largest egg is closest to the cloaca opening. The next largest is to the right, and the smallest is to the left. The size differences between the three eggs isn't even close. This is the strongest indicator for these beings birthing their offspring at different times. This would give the mother time between births and allow for any problems to be solved while waiting for the next offspring to arrive. We can only guess as to the intervals.

One of the most observant people I know, Ben Woodruff, former director of the Hutchings Museum in Lehi Utah, told me that all birds he could think of space them out. Most birds of prey lay each egg, a day to a day and a half apart. He also went on to say that Barn owls almost always have two clutches (each egg a day apart) and then lay another clutch right after the first group hatches. So they end up have two different aged clutches. So within the nest one set will be about fully fledged while the other will be downy and small.

Fig. 118, is one of my favorite CT scan images that was made for the documentaries. Paleontologists rarely, if ever, get soft tissue



Figure 117. NA-01 lateral cross section of body.



Figure 118. NA-01 close-up cross section of the body



Figure 119. NA-01 CT scan, posterior view.

preservation. I have been lucky to get skin impressions of Stegosaurus and Allosaurus in my career, plus nearly a hundred lizard skin impressions out of the Green River Formation. I am very much intrigued to learn what others have to say about *Moultonus dolani*'s anatomy. Again, more extensive studies need to continue.

This description closes with four final full-length images.



Figure 120. NA-01 CT, right side.



Figure 121. NA-01 CT scan, right posterior.



Figure 122. NA-01 CT scan, left posterior.

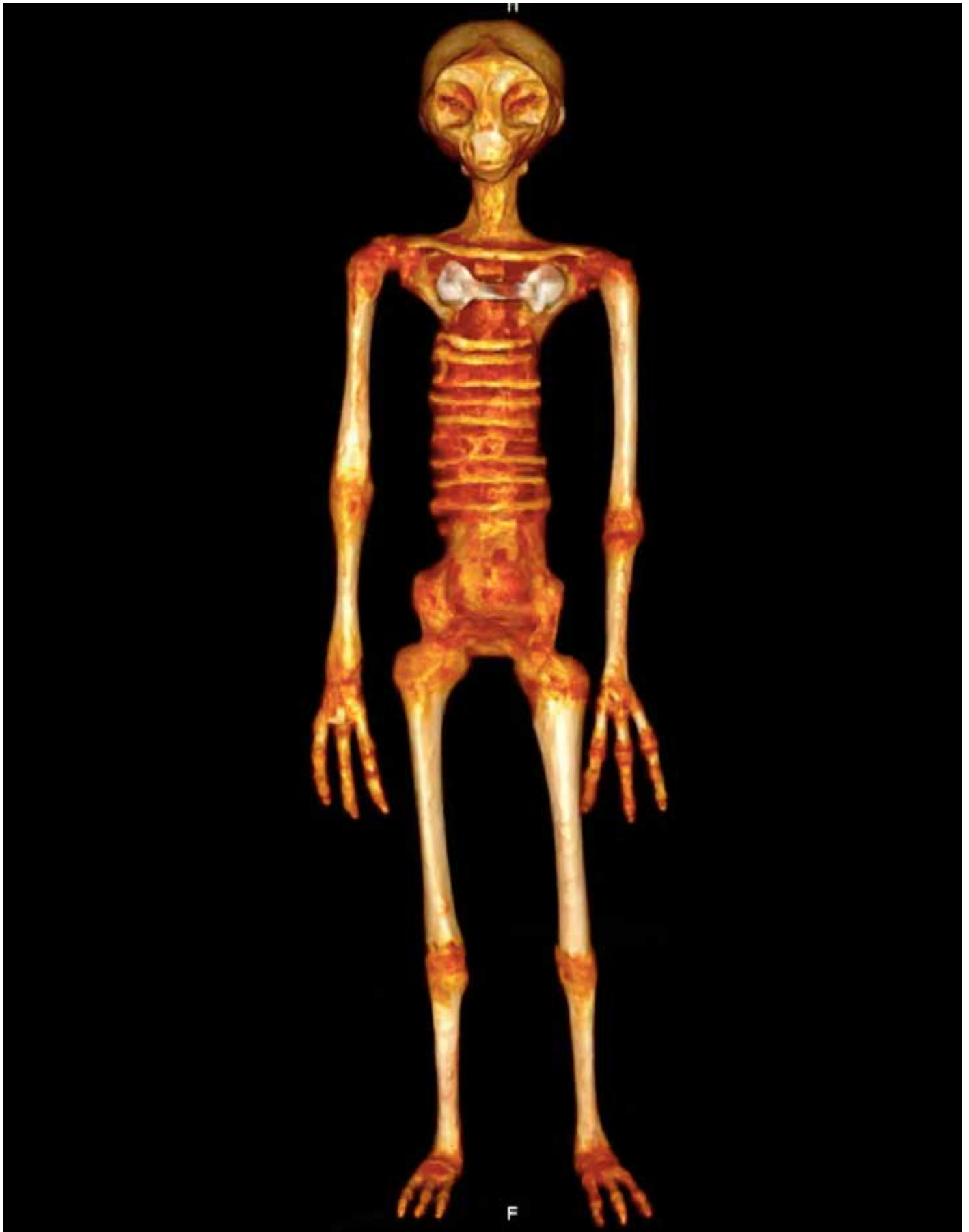

Figure 123. NA-01.

Alien Bodies Addendum



Figure 124. NA-02 (Alberto) and NA-01 (Josephina).



Figure 125. NA-01.



Figure 126. NA-01.



Figure 127. NA-01.



Figure 128. NA-01 close-up of medical device. Note the exposed metal.



Figure 129. NA-01 right hip (ilia). Note how rounded it is.



Figure 130. NA-06, 07, or 08 family member getting CT scan.



Figure 131. NA-06, 07, and 08.



Figure 132. NA-06, 07, and 08 head shots.



Figure 133. NA-01 fingernail close-up.



Figure 134. NA-02 fingernail close-up.



Figure 135. NA-05. Screen shot from Gaia documentary. This is an important image for two reasons. It shows the skin pattern of this species, and it shows a very important feature about posture. On the back you can see a vertebra clearly protruding at the dorsal 7 (rib 1) position. The back slopes from the neck to this point without curving and continues in a straight alignment after this point.



Figure 136. NA-05. This image shows ranges of motion and posture.



Figure 137. NA-05. DNA sample being taken from the iliac crest.



Figure 138. NA-05. Close-up of the DNA sample.

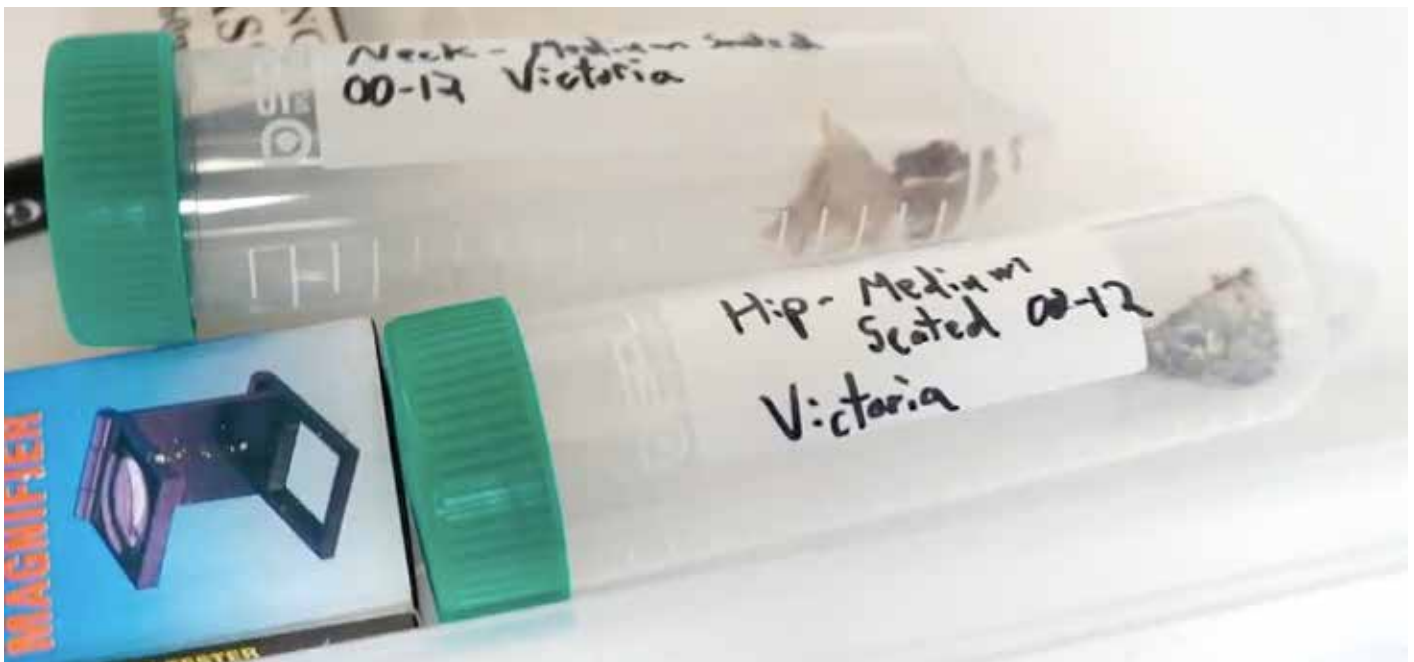

Figure 139. NA-05. DNA samples in vials ready to be sent for testing.

(Variables: d13C = -13.0 o/oo)

Laboratory number **Beta-467733**

Conventional radiocarbon age **1050 ± 30 BP**

95.4% probability

(65%) 987 - 1051 cal AD (963 - 899 cal BP)

(30.4%) 1080 - 1145 cal AD (870 - 805 cal BP)

68.2% probability

(59.9%) 992 - 1044 cal AD (958 - 906 cal BP)

Figure 140. NA-05. Radiocarbon age results, 987–1145 AD.



Figure 141. NA-11 Moultonus dolani infant. I see plenty of infant features, but others will need to do an analysis. This photo came from the Inkari Institute, Instituto-inkari.org, <https://nl.ulule.com/alien-project/>.

Summary



Moultonus dolani, original art by Kelly Pugh, recaptureartworks.com

© 2022 by Kelly Pugh

SUMMARY

The one single glaring attribute that states that *Moultonus dolani* is an alien is that she **looks** like one. She has **all** of the features that are attributed to Gray Aliens. She is only one species of many.

We don't understand all of the anomalous features of this species, simply because we have no idea under what circumstances this species evolved. The conditions on her planet can only be guessed at.

I created the table below when I realized how many fewer bones *Moultonus dolani* has than humans do.

Contrasting postcranial skeletal bone counts for *Homo sapiens* and *Moultonus dolani*—two upright bipedal species.

Bone	<i>Homo sapiens</i>		<i>Moultonus dolani</i>	
Cervicles	Atlas/axis present	7	Atlas/axis absent	5
Thoracic vert	With attached ribs	12	No ribs attached here	0
Dorsal vert		0	Ribs start at D7	17
Lumbar vert		5		0
Sacral vert		5		5
<hr/>				
Total # of vertebra		30		27
Coccyx		1		0
Ribs		24	9 courses of ribs	27
Transition ribs before sacrum		0	left and right	4
Humerus		2		2
Ulna		2	Ulnius	2
Radius		2		0
Carpals		16		2
Metacarpals		10		6
Phalanges		28		18
Ilia 2		2		
Ischia		2	Pelvic girdle absent	0
Pubis		2	Pelvic girdle absent	0
Femur		2		2
Tibia		2		2
Fibula		2		0
Mid & Hind foot		16		0
Metatarsals		10		0
Phalanges		28		18
Totals for the post cranial skeleton:		181		110

Moultonus dolani has **71 less** bones than the average human.

Moultonus dolani was an upright bipedal species with the same basic body design as our own.

- Skulls are small and anteriorly-posteriorly elongated with fused lower jaws and no teeth.
- Prementary features as seen in the Dinosauria. The premaxilla are fused and became a premaxillary plate. You can see in the CT scans that together they make up a premaxillary and prementary shield—Unique.
- No apparent nasal cavity. Paranasal sinuses do not exist—possibly unique.
- Large shallow eye sockets. For the size of the eye, I would have expected much deeper eye sockets. I don't know enough to say how **unique** this may or may not be.
- Lateral sinuses—Unique.
- Occipital foramen—Unique.
- Temporal process—Unique.
- Posterior parietal curve—Unique
- Pronounced mastoid process. This develops in bipeds.
- Square Foramen magnum—Unique.
- Skull is centered over the cervicle vertebrae—Unique.
- Pectoral girdle: *Moultonus dolani* has no sternum, so the clavicles meet at the center—Unique.
- In humans thoracic vertebrae refer to each of the twelve bones of the backbone to which the ribs are attached. Lumbar vertebrae refer to any of the vertebrae situated below the thoracic vertebrae and above the sacrum.

Moultonus dolani's body is the direct reverse of the above definition. She has no thoracic or lumbar vertebrae, so I used term dorsals. She is ribless in the upper portion of her body, followed by 9 ribs beginning at dorsal 7 and descending down through dorsal 17, where her sacrals start. In all of our vertebrates, past and present, I could not find a single example where ribs did not start right after the pectoral girdle—Unique.

- *Moultonus dolani* is missing several centra in her upper body. They are either absent or in the form

of centra plates. Her remaining vertebrae are of normal vertebrate design. It is unknown if the vertebral anomalies in her upper body are due to natural biology or pathology. Further study of other members is going to be necessary to make this determination.

- In *Moultonus dolani* the prezygapophyses are covered by the neural arch of the preceding vertebra—Unique.
- Closed horizontal rib cage—Unique.
- Sacrum absent pelvic girdle—Unique.
- *Moultonus dolani* has long slender limbs. She is absent the ulna and radius and only has an ulnius—Unique.
- The fibula is absent and she only a tibia. While not unique it occurs only in our birds.
- In her hands are 2 carpals (wrist bones) only—Unique.
- In her feet there are no ankle bones and no metatarsals—Unique.
- *Moultonus dolani* has three fingers and three toes. And yet here she is, a space alien with no opposable thumb.
- If her aorta proves to be an aortic heart, that will be an additional **unique** feature.

I have observed at least 15 unique features that prove *Moultonus dolani* did not evolve on Earth. Again, none of these features are in the fossil record. I am sure that when she is studied by scientists with more knowledge than I, even more differences will be found.

**No ancestors in the fossil record
= did not evolve on this planet = Alien being**

**No current vertebrate family to which
Moultonus dolani can be assigned = Alien being.**

These beings are saurians, meaning of or like a lizard. **I recommend the use of *Saurians* as the designated race name** until we have more open communication with them and learn what they call themselves.

LITERATURE CITED

Carroll, Robert L. 1988. *Vertebrae Paleontology and Evolution* (W.H. Freeman and Company), ISBN 0-716-71822-7.

Korotkov, Konstantin. 2019. *The Mysterious Mummies of Nazca: Eyewitness Testimony*, ISBN 9781075152351

McIntosh, J. S., C. A. Miles, K. C. Cloward, J. R. Parker. 1996. "A New Nearly Complete Skeleton of *Camarasaurus*," *Bulletin of the Gunma Museum of Natural History* 1.

**PALEONTOLOGICAL BIBLIOGRAPHY FOR CLIFF MILES**

"Supersaurus in Dry Mesa," in *Dinosaur Science: Prosperity and Mass Extinction* (Japan: Gakken Mook, 1988).

"Skull of a Jurassic ankylosaur (Dinosauria)," *Nature*, 25 June 1988, vol. 393, p. 782–783.

"What do I do with this fossil?" in *A Photographic Encyclopedia of Dinosaurs* (Japan: Gakken Mook, 1990).

"A New Nearly Complete Skeleton of *Camarasaurus*," with John McIntosh, Karen Cloward, Jeffrie Parker, *Bulletin of Gunma Museum Natural History* 1, 1996.

"Evolutionary Significance of New Ankylosaurs, (Dinosauria) from the Upper Jurassic and Lower Cretaceous, Western Interior," with Kenneth

Carpenter, James Kirkland, Karen Cloward, and Donald Burge, *Journal of Vertebrate Paleontology*, 1996, vol. 16, suppl. 3, p. 25a.

"A New Primitive Stegosaur (*Ornithischia*) from the Upper Jurassic," with Kenneth Carpenter, *Journal of Vertebrate Paleontology*, 1997, vol. 17, suppl. 3, p. 35a.

"A New Skeleton of *Coelurus fragilis* from the Morrison Formation of Wyoming," with Kenneth Carpenter and Karen Cloward, *Journal of Vertebrate Paleontology*, 1998.

"Historical Update: Paleontological Excavation in the Como Region," with David Hamblin, in *Marsh's Dinosaurs: The Collections from Como Bluff*, John H. Ostrom and John S. McIntosh, 2nd ed. (New Haven: Yale University Press, 1999) p. vii–xiv.

"A juvenile *Ceratops* (Theropoda, Dinosauria) from Bone Cabin Quarry West (Upper Jurassic, Morrison Formation), Wyoming," *Journal of Vertebrate Paleontology*, 1999, Abstracts, vol. 19 no. 3, p. 33a).

"New Primitive Stegosaur from the Morrison Formation, Wyoming," with Kenneth Carpenter and Karen Cloward, *The Armored Dinosaurs* (Indiana University Press, 2001), p. 55–75.

"A new scaphognathine pterosaur from the Upper Jurassic Morrison Formation of Wyoming, USA," with Ken Carpenter, David Unwin, Karen Cloward, Clark Miles, in *Evolution and Palaeobiology of Pterosaurs*, *Geological Society* (London Special Publications, 2003), 217, p. 45–54.

"New Small Theropod from the Upper Jurassic Morrison Formation of Wyoming," with Kenneth Carpenter and Karen Cloward, *The Carnivorous Dinosaurs* (Indiana University Press, 2005), p. 23–48. This is where we named *Tanycolagreus topwilsonii*.

"Skull of *Minotaurasaurus ramachandrani* a new Cretaceous ankylosaur from the Gobi Desert," with Clark J. Miles, *Current Science*, 2009, 96:1, p. 65–70.

OTHER PUBLICATIONS RELATED TO MY WORK

- The Illustrated Encyclopedia of Dinosaurs* (Salamander Books Ltd., 1985), p. 91.
- “Scientists Believe That They Have Largest Dinosaur Vertebra Ever Found,” Nancy Bringham Perkins, *BYU Today*, October 1987, p. 4–5.
- “Huge Dinosaur Bones Discovered Hollow,” R. Monastersky, *Science News*, 29 April 1989, vol. 135, p. 261.
- BYU Scientists Say World’s Largest Dinosaur Pelvic Bones are Hollow,” Nancy Bringham Perkins, *BYU Today*, July 1989, p. 12–13.
- Dinosaurs Rediscovered*, Don Lessem, A Touchtone Book, 1992, p. 176–178.
- “Studies of Paleoenvironments and Historical Biogeography in the Fossil Butte and Laney Members of the Green River Formation,” Lance Grande, *Contributions to Geology*, spring 1994, vol. 30 no. 1, p. 17, 23, 24. Includes our fossil lily pad that we donated to the Science Museum of Minnesota, our palm leaf that went to the Keiseki Museum of World Stones, and our new alligator species that is in France.
- “It’s a Baby,” Kenneth Carpenter, *Museum Quarterly*, Denver Museum of Natural History, 1997, vol. 6, issue 2.
- “A Dinosaur for the Mantel,” Virginia Morell, *Natural History Magazine*, October 1998, p. 58–65.
- Dinosaurs: The Encyclopedia, Supplement 1*, Donald F. Glut (McFarland & Company, Inc., 2000), p. 213–215.
- Gunma Museum of Natural History*, 2000, introduction, p. 4–7, 9, 12, 17, 44–45. This publication contains an article on our juvenile *Camarasaurus* that we sold to them, our *Diplodocus* skull, our *Camarasaurus* with its pathologies, the *Goniopholis* crocodile that we gifted to them, and an article on collecting.
- “Dino’s Still Rule,” Gail Dutton, *Popular Science*, October 2001, p. 82.
- Dinosaurs of Utah and Dino Destinations*, Pat Bagley and Gayen Wharton (White Horse Books, 2001) acknowledgements, p. 33, 44.
- Dinosaurs: The Encyclopedia, Supplement 2*, Donald F. Glut (McFarland & Company, Inc., 2002), p. 125, 285–287, 301, 354–355, 679.
- “The North American Museum of Ancient Life,” Neal L. Larson, (Dino Press, 2002), vol. 6, p. 4–13.
- Dinosaurs: The Encyclopedia, Supplement 3*, Donald F. Glut (McFarland & Company, Inc., 2003), p. v, viii, 5–11, 13, 16, 17–18, 38, 48, 54, 92, 96, 106, 141, 168, 178–179, 181, 186–187, 195, 199, 222, 254, 258, 263–268, 271, 280, 290, 297, 308, 315, 317, 342–343, 353–359, 370, 427, 459, 461, 464, 532–542, 549–555, 563–564, 568, 571, 577, 588–589, 602–604, 650, 670, 710, 712, 715, 716, 719–722, 724, 726.
- “Cliff Miles: Utah’s Entrepre-saurus Rex,” *Utah Spirit*, January 2004, p. 12–15. Details my background that led to the creation of the North American Museum of Ancient Life.
- The Complete Book of Dinosaurs*, Dougal Dixon (Hermes House, 2006), p. 147.
- “Dinosaur Markdowns,” Susan Adams, *Forbes*, 2009, p. 32.
- Dinosaurs: The Encyclopedia, Supplement 6*, Donald F. Glut (McFarland & Company, Inc., 2010), p. 404–406. Includes *Minotaurasaurus*.
- The Lost World of Fossil Lake*, Lance Grande, (The University of Chicago Press, 2013) p. 192, 212, 213, 376, 377.
- “A new goniopholidid from the Upper Jurassic Morrison Formation, USA: novel insight into aquatic adaption toward modern crocodylians,” Junki Yoshida, Atsushi Hori, Yoshitsugu Kobayashi, Michael J. Ryan, Yuji Takakuwa, Yoshikazu Hasegawa, *Royal Society Open Science*, 8:12, December 2021. This goniopholidid, *Amphicotylus milesi*, was named after me.

This page has no content.

History of the Discovery: Alien Mummies from Nazca, Peru

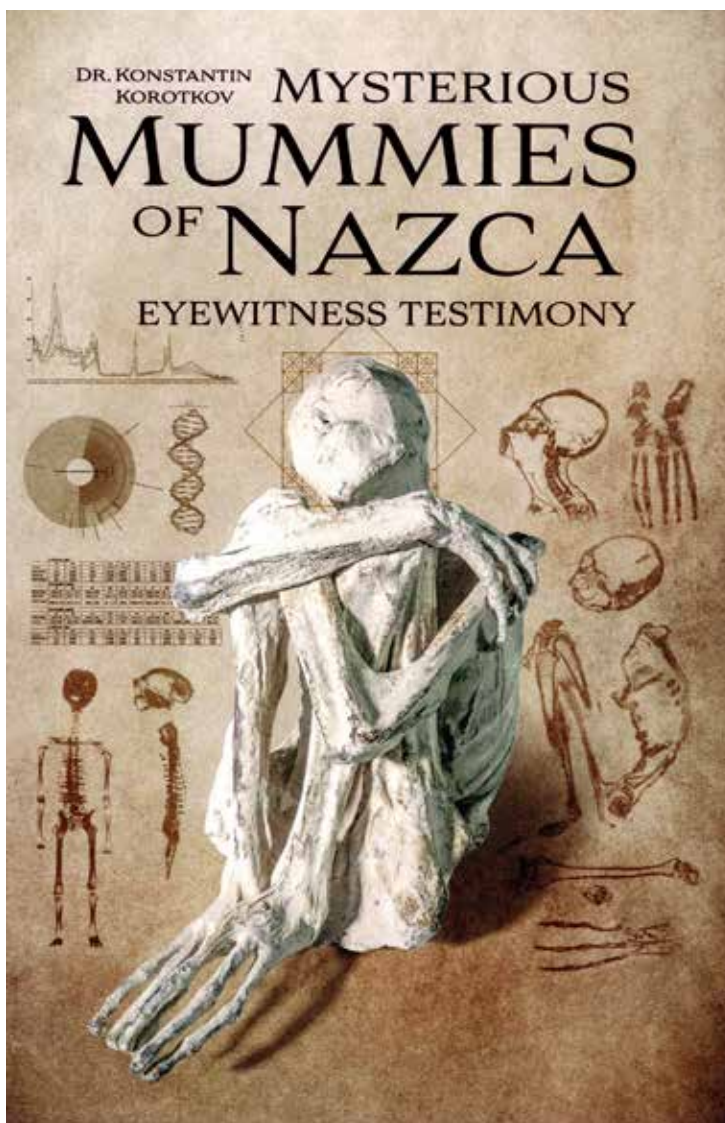

For the species description and the history of discovery sections of this paper, I extensively used two resources:

1. *The Mysterious Mummies of Nazca: Eyewitness Testimony, Dr. Konstantin Korotkov, ISBN 9781075152351.*
2. *Unearthing Nazca: The Complete Story, Gaia documentary, 2019.*

In addition to the above I used the textbook Vertebrate Paleontology and Evolution, Robert L. Carroll, 1988, W. H. Freeman and Company, ISBN 0-716-71822-7. It is the number one resource for all students of vertebrate paleontology. Its 700 pages cover the entire history of vertebrate evolution on Earth, and within it I confirmed my suspicions that these beings did not evolve on this planet.

THE HISTORY

In October of 2016, Leandro Benigno Rivera, an archaeological explorer with 25 years of experience, and a few friends brought in his finds from Nazca to Thierry Jamin, president of the Inkari Institute in Cusco. Jamin, an archaeologist and historian from France, is dedicated to the study of historical Peruvian heritage. He had worked with Rivera off and on whenever Rivera wanted help with identifications.

Jamin noted, “The group was in possession of several little bodies, heads, and hands. They were looking for our professional opinion, and they wanted our help in disclosing the findings. Our first impression was that they were authentic.”

Jamin recognized immediately the significance of the find. Images were uploaded to the internet, so it became public knowledge. Immediately people from all over the world were interested in the findings.

In October/November 2016, Jamie Maussan of Mexico, an award-winning TV investigative journalist for programs such as *El Sol de Mexico* and *60 Minutes*, saw the images. What he saw didn’t look human, and initially he thought they were fakes. A few months later in March 2017, a biologist contacted him and said, “Look at this. This is very interesting. Have you talked to Thierry Jamin?”

“So I interviewed him on my program on the internet,” Maussan recalled, “and I thought that this was very serious. I thought this was very important. This man had credibility, and I said, ‘I have to go to Peru.’”

Jamie Maussan contacted Gaia—a member-supported media network of truth seekers to see if they wanted to investigate the bodies with him and his team.

Melissa Tittl, director of content for Gaia, stated in the documentary, “Our real mission on taking this lead, following Jaime to see these bodies was just to see what it is. We’re just literally there because we’re curious about what it might be.”

Several crews consisting of camera operators, translators, journalists and forensic experts headed to Cusco, Peru, to see the pieces for themselves.

Thierry thought the best thing to do was to alert the Peruvian authorities, so that they could join in

the discovery. On January 11, 2017, Thierry Jamin sent a letter to Dr. Jorge Nieto Montesinos, minister of defense for Peru, to inform him of the findings and to request his participation in the investigation. However, an official response was never received.

An archaeologist named Alberto Jacinto, head of the culture department at Nazca got in touch with Thierry via email to let him know that the minister in Lima had assigned him the case and urged him to investigate.

People from five countries came together to do the investigation. Dr. Konstantin Korotkov took the lead. There were journalists from Mexico and Peru and the journalistic team from Gaia in the U.S.; biologists and forensics doctors from Mexico, the U.S., and Peru; as well as archaeologist Thierry Amin. Their goal was to come to an objective explanation of the discovery.

Dr. Korotkov wrote,

Periodically in different fields of science, there comes a complete revision of views. We observe shifts of paradigm in the universal sciences of medicine and physics, not to mention technological achievements. Another area of knowledge requiring radical revision is mankind’s ancient history. More and more facts collect to erode the simple linear schemes at the foundation of Darwinian concepts and testify to civilization developing in much more complex way.” [*Mysterious Mummies of Nazca*, p. 7–8]

The first two pieces that the team of scientists, researchers, and media personnel saw on a second trip were two elongated heads. On one of them you can see the atlas or C1. Later three more bodies, named “the family,” were discovered in the same cave.

During their first trip, someone had shown the ministry of culture a three-fingered hand, and the ministry labeled it as a fraud. They declared that the hand had been intentionally mutilated by removing two fingers and that smeared plaster gave the hand a mummified appearance. Additionally the ministry declared the work was done in a workshop in Nazca. Thus began the poisoning of the whole project.

Sometime later Mr. Jamin showed the team a couple of bodies that were about 60 centimeters long. It is these bodies that are the subject of this paper.

There are remains from eight individuals—five complete bodies in the corpse pose, a seated individual with no head, and two loose heads. [Am I remembering correctly that you said there were more?]

Later the group took the bodies to a clinic to perform X-ray and CT scans. What they discovered in the X-rays was that there was a piece of metal over the chest of the female. In addition, you could see three eggs where the bulge in her belly was and what appears to be a birth canal.

The team was very impressed, so much so that Mr. Leandro Rivera promised more bodies. Later the team was taken to his home where Mr. Rivera promised to have a big surprise.

What the team saw was a human-looking mummy whose hands and feet each had three long digits. The mummy had an enlarged skull and no ears. Genetic studies later determined that the body is a female and it was subsequently labeled “Maria.” Maria is actually a desiccated body and not a mummy. She is complete with her internal organs.

The team took tissue samples of the body that were to be tested in different laboratories in Russia, the United States, Canada, and Mexico. The X-rays and topographies showed surprising results. She is real and complete with no alterations whatsoever. All of her skin is intact with no lines anywhere that would indicate that she had been modified. Later CT scans were performed so that there would be more data with which to work. The CT scans were shown to Natalia Zaloznaja, MD, PhD, head of image analysis of the Medical Institute MIBS at Saint Petersburg Federal University in Russia. “It is the skeleton of a person with an anomaly—it’s three fingered. She is very well preserved.”

The CT scans were also shown to M. K. Jesse, a musculoskeletal radiologist at the University of Colorado Hospital. “The bones of any mammalian skeleton are incredibly complex.” She determined that Maria’s skeleton appeared to be “normal” with the exception of her elongated hands and feet with only three fingers and toes. She noted that Maria’s wrist bones were thick and her finger bones robust. The elongated skull was also notable, and Jesse observed that she could “see no suture lines in the skull. They all appear fused.”

It was at this point that the team considered that they likely had a new species of human.

The white powder that covered the bodies was not plaster. It was later determined to be diatomaceous earth—a fossilized microscopic algae. It has absorbent qualities and also acts as a natural insecticide by getting in small places and cutting insects up in such a way that they do not survive for long. The diatomaceous earth within the cave has been dated to approximately 18 million years old.

At this point in the history the team was informed of 2 more bodies. One was the headless alien called Victoria and a baby called Wawita with the same features as Maria. (The name *Wawita* means *baby* in the Quechua dialect.) Wawita appeared to have been tampered with, so focus was placed on the other bodies.

The results of the carbon 14 dating came in from Mexico. Maria was found to be approximately 1,771 years old plus or minus 30 years. This places her in the period of time the Nazca culture was flourishing.

Gaia also did its own testing on Maria and Victoria at a company called Beta out of Miami, Florida. They got the results back on June 26, 2017. The numbers came out to be the same for Maria—approximately 1,700 years old.

In the documentary, Victoria was dated to around 800 A.D., making her 1,200 years old. In Dr Korotkov’s book he states that Victoria was dated as being much much older. On pg. 52 he states that the first date came back as 6,420 +/- 30 years. A second sample was sent in with a different field number label, and it came back as 3380 +/- 30 years. You have to wonder if the lab that performed the dating had large “C” (calibrated dating) as opposed to small “c” (uncalibrated dating). Calibrated dates are more accurate because they take in the dendrochronology of tree rings. Scientists learned some time ago that there was a problem with carbon-14 dating. The levels of C14 in the earth’s atmosphere over the past 8,000 years have been subject to significant fluctuations.

Once this was understood, a model was created to take this into account. More C14 tests are going to be needed in order to get a more accurate age for Victoria.

More DNA was taken to see if they matched any modern human species or any other biological species on the planet.

The team reached out to other archaeologists, inviting them to come see for themselves, but they refused. There was an active effort by officials to keep any information from surfacing about the “mummies.” Participation by ministry scientists has been non-existent to this day. I am amazed at how often arrogance gets in the way of progress.

More DNA was taken by Dr. Konstantin on his last visit before he had to return home, and the sample was sent to Russia. Tests were performed by the Institute of Analytical Chemistry, University of St. Petersburg. The testing took just over a month. This is when Maria was confirmed to be female because her DNA included an x chromosome. Sequencing was the next step for Maria.

Even more DNA was extracted for further tests. It was collected from Maria, Wawita, and Josephina the female alien.

After they returned home they began to get results. At St. Petersburg State University, Evgeniy Borisovich Serebryakov, PhD, concluded from a chemical analysis that the sample contained an ordinary set of elements except for cadmium. “We have found cadmium chloride on the surface of the specimens. The specimens were covered with cadmium chloride and diatomaceous earth.

Dr. Konstantin, “As far as I understand cadmium chloride is not found at all in nature.”

Dr. Serebryakov, “Cadmium needs to be acidized, extracted, then transformed into a soluble form, into cadmium chloride. It also needs to be purified for sure. It is a complicated procedure.

Dr. Konstantin, “So it is unobtainable or impossible for the primitive civilizations. Is that correct?”

Dr. Serebryakov, “If they do not have concentrated acids and simple chemical reactors then it is really impossible.”

Dr. Konstantin, “It is clear that all the subjects, were processed with cadmium chloride and those elements may be created only by a highly developed civilization. It’s not simple people living in Nazca area, different tribes who were able to make this chemical process. Our European civilization came to process it only in the middle of the nineteenth

century. And now we use a lot of cadmium chloride in our civilization to preserve different subjects because this is the best preserver that kills all bacteria, all combinations and viruses. So we use it in our modern life a lot, but it doesn’t exist in nature.”

Later they were taken to the cave. It is located between the Nazca Lines and the Palpa Lines within the boarder of Palpa and Nazca. You can see from the photos that it is covered from ceiling to floor with diatomaceous earth dated to around 18 million years old. This is when they confirmed that this was indeed the place where all of the “mummies” were found.

More DNA samples were taken and unique and new data was obtained for Maria and Wawita. William Brown, a biophysicist and molecular geneticist from Southern California, stated:

Of the DNA that was isolated, only 25% of the total matched any known human gene. So that means that 75% of this DNA is not matching any known human reference sequence. And this is pretty rigorous because, there is the 1000 genome project, where that have done whole genome sequencing of over 2000 individuals, from every continent on earth and compiled an average reference human genome. So you take these sequences isolated from this being, you go compare them to that reference genome data and only 25 percent match up. 75 percent don't. [at 45:20 of the documentary]

Dr. Doug Taylor is a professor of biotechnology at the University of Harrisburg. He explained that DNA sequencing is evolving, and it depends on the question you want to answer, which will determine what direction to take in isolating the DNA. “This is an incredibly interesting find and really needs to be looked into,” he concluded.

Victoria’s DNA samples taken from the neck and hip went to Mexico and Russia. Dr. Konstantin said, “Of all known DNA, organic life, I mean human, animals, plants, bacteria, microbes, there is NO correlation with Victoria—no match at all, So it is clear to scientists that *it is something different*. This is something amazing and never before seen.

On August 18, 2018, high-quality CT scans were obtained of both Maria and Josephina. It was during this part of the investigation that they learned that



On the way to the cave.



Outside the cave.



Diatomaceous earth is everywhere!

Interior of the cave.



A previous discovery.



"Victoria" left and an unknown individual not part of the study.



In that moment, I really felt we were proving something.

Exiting the cave.

Maria was missing her lower organs. From injuries observed it was determined that she was likely killed by a jaguar.

The construction of Maria's ear bones is different than ours. Construction of nasal bones are also different.

Victoria the Victor: What I mean by this statement is that when the first DNA results were obtained, it became clear that Victoria was male because the DNA contained a Y chromosome. However, for the ease of this paper I will continue to use the original name that was given.

Cen4gen labs from Edmonton, Alberta, Canada, performed the sample processing and sequencing. The fact that DNA was extracted proves that they are real. The Canadian laboratory had a greater amount of material, so that they were able to do better sequencing. The computerized analysis of the data showed this DNA does not coincide with any human being or living organisms—that the specimens were an unknown species of living beings.

The Peruvian government was very adamant they did not want to be involved, but they let the testing continue privately.

Later at the end of the team's investigations, they had a chance to present their findings to Peruvian government decision-makers and none of them supported continued investigation. After this the Peruvian government went dark! I wonder why. Do they have an agreement with the "powers that be" who keep this kind of research suppressed. It has

been more than five years, and we have heard nothing. That is why I decided to take action.

After all of the backlash, a university took interest in the bodies. The last known location for the specimens is the Universidad Nacional San Luis, de Ica, in the town of Ica about 190 miles south of Lima in the Nazca region.

All of the bodies went there except Josephina, which I have chosen as the Type for the species. Leandro Benigno Rivera refused to turn her over because he believes that she has great monetary value. I agree with him and think he should be compensated appropriately and forgiven because he is in a legal gray area in regard to keeping her.

Peru needs to embrace its alien heritage, even if for only the reason that it would greatly increase tourism to Peru. For reasons currently known only to the aliens they chose Peru. They must have seen something special about the Peruvian people.

What has now become known is that at least one alien race has had a hand in our history. To what extent is still to be uncovered. Many have tried to point this out. Men like Erich Von Daniken who wrote "Chariots of the Gods." The ideas put forth in his book are rejected by virtually all scientists and academics who categorize his work as pseudohistory, pseudo-archeology and pseudoscience. These alien beings were discovered in Nazca—ground zero for Von Daniken's work. He has now been vindicated. A complete reassessment of the Nazca lines is about to be rewritten. Giorgio A. Tsoukalos is now your expert in this field.











Lleandro Rivera



Evgeniy Borisovich Serebryakov, PhD / Russia
Head of the Center of Analytical Chemistry
Saint Petersburg State University



Doug Taylor, PhD / USA
Professor of Biotechnology at University of Harrisburg



Ben Rich:

Lockheed Martin Skunk Works



Lockheed Martin Corporation is an American aerospace, arms, defense, information security, and technology corporation with worldwide interest. Ben Rich ran Lockheed Martin's Skunk Works, which was where Lockheed Martin's most secret work was accomplished. After Ben Rich retired he had a great many opportunities to speak. When he did, he gave indications of what was out there in regard to our ability to travel in outer space. He made his strongest statement just before he died. "Jim, we have things out in the desert that are fifty (50) years beyond what you could possibly comprehend. If you have seen it on Star Wars or Star Trek, we've been there done that, or decided it was not worth the effort." (Source: Direct comments by Ben Rich to Jim Goodall via telephone call at the USC medical center approximately one week before Ben passed away on January 5, 1995. See secretprojects.co.uk/threads/lockheed-skunk-works-ben-rich-comments-revealed.5048/)



In the summer of 1972, Ben Rich, one of the most seasoned engineers in Lockheed Martin's Skunk Works® division, stood nervously outside the office of his boss, the legendary Clarence "Kelly" Johnson.

In the 18 years since Johnson recruited Rich to join Skunk Works, the two men had developed a unique, almost father-son, relationship. Rich had helped his mentor shore up thermodynamic and propulsion issues with some of Johnson's most famous creations, including the F-104 interceptor and SR-71 Blackbird. And in return, Johnson had taken Rich under his wing, letting him tag along to meetings with military officials.

Rich had come to tell Johnson that he'd been offered a new position at a rival airplane manufacturer. Kelly listened, shook his head, and then offered up a secret of his own.

Johnson told his protégé that in three years he would be retiring. And when he did, he planned to personally recommend Rich to take over as director of the Skunk Works, the most prestigious engineering post in the history of aviation.

Rich stayed. And Johnson delivered on his promise, helping his protégé win the post he not only desired but richly deserved.

[\[lockheedmartin.com/en-us/news/features/history/rich.html\]](http://lockheedmartin.com/en-us/news/features/history/rich.html)

JAN HARZAN INTERVIEW

Jan Harzan, MUFON Board of Directors, B.S.

nuclear engineering: In 1976 I got a flier from the school of engineering inviting me to a lecture by Ben Rich.

Narrator: Ben Rich was the director of Lockheed Skunk Works for 16 years. [Skunk Works is the official alias for Lockheed Martin's Advanced Development Programs.] He oversaw several USAPS [Unacknowledged Special Access Programs] that were secretly managed at Skunk Works, including most notably the development of the F-117 stealth fighter.



Jan Harzan. Screenshot from Sirius documentary, directed by Amardeep Kaleka, 2013.

Jan Harzan: Ben shared a slide set of about 40 slides of different things, starting with the U-2 spy plane going all the way up to the stealth fighter at that time, mentioning that he couldn't talk about the other secret stuff. But when he ended his talk, he had a slide of a black disk zipping off into outer space, and he ended his talk with these words, "We now have the technology to take ET [extraterrestrials] home." [Not a reference to the Steven Spielberg movie.]

... Later, we asked him questions about it. "What did you mean when you said, 'We now have the technology to take ET Home.?'"

Ben shared three major things that I think are worth of research by researchers worldwide at this point in time.

First, we've somehow figured out *how to do interstellar travel already, It's known.*

[CAM: Since this is known we just need to get it exposed.]

Jan Harzan: The second point he made was that there was an error in the equations. My suspicion is that it's probably Maxwell's equations for electromagnetic theory.

The third thing he said was, "How does ESP work?" And I was really kind of startled because I didn't know what to say. But I blurted out, "I don't know. *All points in time and space are connected.*"

And he looked me back in the eye and said, “*That’s how it works!*”

[Jan Harzan interview excerpts from *Sirius* documentary, directed by Amardeep Kaleka, 2013.]

[CAM: Our remote viewing teams should be able to help here. They are up and running you just need to find out what the current name is for the program. Every part of the universe is invisibly linked to the rest through a network of sympathetic connections. Not my original concept, but I believe it.]



F-117 Stealth fighter developed by Ben Rich’s team.

BEN RICH QUOTES

The following are significant statements made by Ben Rich, former head of Lockheed Skunk Works, specifically pertaining to advanced propulsion/space travel. All have been 100 percent verified and authenticated.

“Dear John, Yes, I’m a believer in both categories. Feel anything is possible. Many of our man-made UFOs were UnFunded Opportunities. In both categories, there are a lot of kooks and charlatans, be careful. Best regards, Ben Rich.” [21 July 1986 letter from Ben Rich to John Andrews (Testors Corporation) who asked Ben if he was a believer in A) man-made UFOs, and B) extra-terrestrial UFOs]

“I wish I could tell you about the projects we are currently working on. They are both fascinating and fantastic. They call for technologies once only dreamed of by science fiction writers.” [AIAA (American Institute of Aeronautics and

Astronautics) lecture, Atlanta, GA, 7–9 September 1988]

“We did the F-104, C-130, U2, SR-71, F-117 and many other programs that I can’t talk about. We are still working very hard, I just can’t tell you what we are doing.” [1993 WPAFB (Wright-Patterson Air Force Base) slide presentation]

“The Air Force has just given us a contract to take ET back home.” [1993 WPAFB (Wright-Patterson Air Force Base) slide presentation]

“We now have the technology to take ET back home.” [UCLA School of Engineering Alumni speech 2 March 1993]

“We now know how to travel to the stars.” [UCLA School of Engineering Alumni speech 23 March 1993]

“There is an error in the equations, and we have figured it out, and now know how to travel to the stars, and it won’t take a lifetime to do it.” [UCLA School of Engineering Alumni speech 23 March 1993]

“It is time to end all secrecy on this, as it no longer poses a national security threat, and make the technology available for use in the private sector.” [UCLA School of Engineering Alumni speech 23 March 1993]

“There are many in the intelligence community who would like to see this stay in the black and not see the light of day.” [UCLA School of Engineering Alumni speech 23 March 1993]

“We have some new things. We are not stagnating. What we are doing is updating ourselves, without advertising. There are some new programs, and there are certain things—some of them 20 or 30 years old—that are still break-throughs and appropriate to keep quiet about. Other people don’t have them yet. [Statement made by Ben Rich to Stuart F. Brown in an interview published in *Popular Science*, October 1994]

“We already have the means to travel among the stars, but these technologies are locked up in black projects, and it would take an act of God to ever get

them out to benefit humanity.” [Statement made after UCLA presentation to three Disclosure Project witnesses]

“Jim, we have things out in the desert that are fifty (50) years beyond what you could possibly comprehend. If you have seen it on Star Wars or Star Trek, we’ve been there, done that, or decided it was not worth the effort.” [Direct comments by Ben Rich to Jim Goodall via telephone call at the USC medical center approximately one week before Ben passed away on 5 January 1995]

*For more information contact: Michael Schratt
Email: auroracad5@aol.com*

[\[secretprojects.co.uk/threads/lockheed-skunk-works-ben-rich-comments-revealed.5048/\]](https://secretprojects.co.uk/threads/lockheed-skunk-works-ben-rich-comments-revealed.5048/)

WHAT SHOULD WE CONCLUDE ABOUT BEN RICH?

Is Ben Rich telling the truth or is he lying? Is the man picked to run Lockheed Skunk Works lying? Was this man who was a member of the National Academy of Engineering, who won numerous awards during his career—including the Collier Trophy—lying? (The Collier Trophy is an annual aviation award administered by the U.S. National Aeronautic Association presented to those who have made “the greatest achievement in aeronautics or astronautics in America, with respect to improving efficiency and safety of air or space vehicles, the value of which has been thoroughly demonstrated by actual use during the preceding year. It was awarded to Ben Rich in 1989 for the first stealth aircraft, the F-117.)

Was this man who in 2005 was inducted into the National Aviation Hall of Fame lying? Was this man who in January 1981 received the Department of Defense Medal for Distinguished Public Service for his work on the F-117 Stealth Fighter lying? (He received this medal in a secret ceremony in the office of then Secretary of Defense Harold Brown.)



The face of an honest man.

Lying? No—he was not!

So since Ben Rich was telling the truth, where are all of these wonderful creations that he talks about? I suggest that the United States Air Force has them. This is the branch of the military who stays quiet about all of the UFO stuff because a large percentage of it is ours. Don’t get me wrong I love the Air Force, and I understand completely why they changed the Roswell UFO crash story almost immediately. By keeping it secret we would have an opportunity to reverse engineer the technology. According to Bob Lazar and Ben Rich this was done.

We’ve got to crack them open. It’s critical for our survival—especially if you believe the binary coded messages from Rendlesham Forest and Wadley, Georgia. (See pages 163–188 of this paper.) You can’t ignore the binary coded pages. They exist; they are real. They have been translated by multiple code breakers. Somewhere hidden from us the United States has flying saucers or Tic-Tacs or triangle-shaped craft—likely all three.

It is Ben Rich’s integrity against the Air Force, and I side with Ben Rich.

The Wilson Memo

Eric W. Davis & Vice Admiral Thomas R. Wilson



Eric W. Davis



Vice Admiral Thomas R. Wilson

The Wilson Memo contains 13 pages of notes by Eric. W. Davis about a meeting with Vice Admiral Thomas R. Wilson concerning his frustrations in trying to be informed about projects he was responsible for overseeing, meeting road blocks, and having his career threatened. During the meeting they discussed UFOs, MJ-12, Roswell, crashed UFOs, alien bodies, etc. The memo also includes a copy of a 2-page letter from Commander Willard Miller to Dr. Eric Davis dated April 25, 2002, in which UFOs, UFO crash retrievals, and Area 51 are mentioned.

VICE ADMIRAL THOMAS R. WILSON

In May 1999 Thomas R. Wilson was nominated by the President and confirmed by the Senate for promotion to vice admiral and appointment as the thirteenth director of the Defense Intelligence Agency. He assumed that post on 27 July 1999, relieving Lieutenant General Patrick M. Hughes, US Army. As DIA director VADM Wilson also served as the chairman of the Military Intelligence Board (MIB) consisting of the military service intelligence chiefs, the combatant command directors of intelligence, and the directors of the intelligence community's designated combat support agencies—the de facto director of Military Intelligence. Other flag rank assignments included director of Intelligence (J2), The Joint Staff; associate director of Central Intelligence for Military Support, Central Intelligence Agency; vice director of Intelligence, The Joint Staff; and Director of Intelligence, United States Atlantic Command.

Following retirement from the Navy in 2002, Wilson served in several senior executive roles for Alliant Techsystems, Inc. (ATK): president of ATK Missile Systems, corporate senior vice president and president of ATK Precision Systems Group, and ATK senior vice president for Tidewater Operations, retiring from ATK in 2009.

[\[en.wikipedia.org/wiki/Thomas_R._Wilson\]](https://en.wikipedia.org/wiki/Thomas_R._Wilson)

THE OUTSIDER, THE INSIDER, AND THE BENEVOLENT COLLABORATOR: THE ADVENTURES OF SCIENTIST ERIC W. DAVIS

By Anonymous

Special Interview on Davis–Wilson

Host: Richard Dolan
September 25, 2021

Anonymous is a researcher with whom Richard Dolan has worked for many years.

This summary and analysis of Dr. Eric W. Davis and the Wilson Memo are from Richard Dolan's website: richarddolanmembers.com.

Abstract: The life of Eric W. Davis has been an astonishing adventure. During the course of his journey, he not only had a meeting with Admiral Thomas Wilson during which he was told about UFO reverse engineering programs being operated without oversight, but was also informally (or maybe formally by now) read into a Lockheed reverse engineering program by a former vice-president of Lockheed Martin. He provides tidbits of information about this individual and what he revealed in various interviews that are available online. Finally, it's suggested that Eric W. Davis is probably attempting to work from the inside out to end the UFO cover up. Even though this probably won't be successful due to the fact it's not in the interests of the aerospace corporations to reveal anything at all, we should respect and thank Eric Davis for his research in multiple fields and for what he has shared with the UFO community. Now, it's time for him and others with actionable information to share all they know to force disclosure so this deception can finally come to an end.

Summary

Extraterrestrials, among other non-human intelligent entities, are visiting our planet and have likely been inhabiting it for ages. Moreover, the military industrial complex, multiple private corporations, and legacy aerospace corporations have participated not only in the perpetual cover-up of crashed and landed vehicles, but they have conducted reverse engineering programs. This is what scientist Eric W. Davis believes if you read his public statements, take the time to analyze his writings, and listen to what he has said during multiple podcasts and radio shows. But he hasn't formed this opinion simply by watching random UFO videos on YouTube. As a professional scientist, he has spent his entire life conducting careful research to unlock fundamental truths about physics and the UFO phenomenon. Due to his top-notch research and steadfast efforts, he made connections and friendships that opened doors to wondrous places: Robert Bigalow's NIDS (National Institute for Discovery Science), Harold Puthoff's company Earthtech, the staff car of Admiral Thomas Wilson, the SCIF of a former vice president of Lockheed Martin, and most recently the ultra high-tech Aerospace Corporation.

This series of doors that opened and what transpired are real, which I have no reason to doubt. Lue Elizondo, the former director of AATIP (the Advanced Aerospace Threat Identification Program) has gone so far as to declare him a “national treasure” and someone he believes to be incapable of lying. Coming from an expert judge of character like Elizondo—who helped manage security for Special Access Programs while working in the Pentagon—this sort of statement isn’t trivial. It means Eric W. Davis is the real deal. The long list of praises from multiple parties indicates he’s a trustworthy ally in the battle for scientific discovery. Due to this, when he makes a statement, I listen. In fact, I listen intently. For he is someone who has the educational background, field experience (working at Skinwalker Ranch), education, and contacts to know things the vast majority of people won’t.

To keep this article from turning into a book, I’ll skip his early career and most of his experiences with NIDS to focus on the most interesting adventures he’s experienced that we know about. There have almost certainly been others that have been hinted about online by people who admit they are blabbermouths. But even if all the most astounding experiences of his life so far have been disclosed online, they are enough to make for a best-selling three-part biography.

The Outsider

To get started, let’s talk about the leaked document known as the EWD (Eric W. Davis) Notes, or the Admiral Wilson Notes, or the Admiral Wilson document. They are an account of a real meeting between him and Admiral Thomas Wilson in a staff car in Las Vegas. If you want to know the full details of what transpired, the questions he asked the admiral, and what he was told, go online and do a search.

Essentially, however, in April 1997, while Wilson was Deputy Head of Intelligence for the Joint Chiefs of Staff, he agreed to a meeting with UFO researcher Steven Greer, Apollo 14 astronaut Edgar Mitchell, U.S. Navy Commander Willard Miller, and a small, select group of other individuals to discuss the runaway nature of UFO secrecy. After this meeting, Wilson searched for, and eventually found, critical evidence of genuine Special Access Programs (SAP)

that were concerned with UFOs and possible extraterrestrials. When he tried to gain oversight access to one of these programs, Wilson was completely shut down and threatened by his superiors. In October 2002, after he had retired from U.S. government service, Wilson met with Dr. Eric Davis and described his experience. Davis took detailed notes, which he shared with a close group of colleagues, primarily in the National Institute for Discovery Science (NIDS), which included Edgar Mitchell and a small number of other individuals. From that point the notes appear to have been shared with only a handful of individuals (including UFO researcher Richard Dolan in 2006), until they were leaked during the late spring of 2019.

For our purposes, there’s no point in going into greater detail at the moment. What’s important is that everyone in the world recognizes it was a real event. The phony notions being passed around the internet by certain parties and individuals that the document is anything other than an accurate written record he wrote after meeting with Adm. Wilson are intentional disinformation. Every objection is nonsensical while the evidence in favor of the reality of the document is huge. . . .

Let’s get one objection out of the way. The “NRO document” or security alert that Dr. Steven Greer had his military advisor Commander Willard Miller provide Adm. Wilson before their meeting at the Pentagon is not critical to the reality of the EWD Notes. *First, nowhere in the EWD Notes is the NRO document mentioned by Adm. Wilson, Willard Miller, or Eric Davis.*

Now, it’s interesting that Willard Miller has stated he was told by Adm. Wilson’s aid at the end of the Pentagon briefing that they knew of MJ-12 or an organization like it, had made contact, and were then told they didn’t have a need to know. But this organization or program was NOT one of the FOUR programs Adm. Wilson later discovered. It’s important to mention this because Dr. Steven Greer has claimed all of Wilson’s discoveries resulted from reading the list of codenames on the NRO document.

In fact, the NRO document did not lead him to these. Dr. Steven Greer may make it sound like the NRO document was the key to his discovery of the

carved, waived, unacknowledged SAPs hoarding UFO craft without oversight, but it was not.

The truth is explained in the EWD Notes. Admiral Wilson was told where to look for the programs after asking former Secretary of Defense Bill Perry and the previous members of the leadership team of the Senior Review Group of the Special Access Program Oversight Committee. This included the former Director of Special Programs Gen. Mike Kostelnik who would have been a key person to know due to the fact that he was also the director of the Special Access Program Coordination Office. Paul Kaminski, former Under Secretary of Defense, who would have been the former chairman of the leadership team of the Senior Review Group, was also someone who provided him assistance. Along with Gen. Marshall Ward, these were the individuals that assisted Wilson in finding the programs. So, yet again, the NRO document is not critical or foundational to anything. It's only a part of the story that's not even included in the text of the EWD Notes.

Finally, the absolute authenticity of the NRO document is not important at all. All that matters is that Adm. Wilson recognized a codename—which was real—and used it to try to gain access to a program before the meeting with Greer and his associates at the Pentagon. It's completely irrelevant if some other part of the document is made up or fictitious, or possibly not. History will record that he used a real codename to get his first denial and learn that MJ-12 or a program like it did exist.

Here is the statement from Willard Miller:

“Yes. Yes. It was also a little interesting aside, as I was leaving, the admiral’s aid turned to me and said, ‘You know, the subject of Majestic MJ-12 came up and there’s been a lot of debate as to, you know, whether that’s real, whether it ever existed.’ And he said, ‘You know, we know it exists. We here at the Intelligence Directorate for the Joint Staff just don’t have the need-to-know what they do.’ And I found that to be a very interesting statement.”

There are other made-up, fake objections that are able to be dismissed if you look at the evidence.

- It’s not a movie script. There are many reasons that it’s not. One reason is that it’s not written like a movie script. If it were a movie script, he would have at least made a basic attempt to write it like one. Yet another reason is not a single individual that had been a member of NIDs has ever portrayed it as a movie script. Instead, they give strange statements which are clearly NOT denials publicly and privately give other statements that only seem to make those that receive them believe more wholeheartedly in the reality of the notes.
- Eric Davis did not meet with someone pretending to be Admiral Wilson. This is absurd beyond belief.
- The full chain of custody of the document is known by researchers. This includes the name of the individual who rescued the document from Edgar Mitchell’s estate.
- It wasn’t a mean-spirited hoax to try and deceive the gullible aging Edgar Mitchell. The membership of NIDS highly respected Edgar Mitchell. In fact, he was a consultant to their organization. No one in their organization would have ever pulled such a prank.

Due to the number of made-up, obviously false theories floating around that try to dismiss the reality of the EWD Notes, I won’t list them all. The above are simply a handful off the top of my head. What’s more important is to show how and why the EWD Notes or the Admiral Wilson document is a completely legitimate record of a real meeting that took place in his staff car. In all fairness, we don’t know if everything Adm. Wilson told Davis was the truth, although there’s zero reason to believe he’d lie if he were taking such a risk to meet with him. Also, there’s reason to believe the “gatekeepers” Adm. Wilson flew out to see could have lied to him (perhaps about no progress being made). Yet what’s clear is that the EWD Notes themselves are Eric Davis’ attempt to provide an accurate account of what transpired at the meeting and what was said. Knowing that he would share it with his most trusted colleagues, he would have done his best to recall every important detail revealed to him. This is the ultimate hot potato, folks: a document that can

direct us all to where the “core secrets” are sequestered from humanity.

A good place to begin would be the Advanced Theoretical Physics (ATP) group meetings that took place at the BDM corporation during the 1980s. The ATP meetings were gatherings of experts in the field of UFOs or related subject areas such as remote viewing and psychokinesis that met in a secure facility at BDM Corporation. The ATP group meetings are mentioned briefly in the EWD Notes. If you read the notes, you will see that it was an individual by the name of Oke Shannon that convinced Adm. Wilson to meet with Eric Davis.

One giant boulder of evidence that composes the mountain of proof of the document’s authenticity is that UFO researcher Grant Cameron has revealed that many years previously Eric Davis gave him Oke Shannon’s notes from the ATP group meetings. This proves that Eric Davis and Oke Shannon did in fact have communication with each other. In fact, John Alexander, whose name is abbreviated in the EWD Notes as “JA” lists both Oke Shannon and Eric Davis as either participants or contributors to the ATP group meetings in one of his books.

Here is Grant Cameron on Oke Shannon, Eric Davis, and the EWD Notes:

“And I’m looking at this document and I see Oke Shannon on the front cover of this document. And I go, “Oh my God.” Because I know who Oke Shannon is. Nobody else knows who Oke Shannon is. Twenty years ago, Eric Davis gave me a set of notes from the UFO working group. Twenty-six, twenty-seven pages. So, he gives me these documents and he says, “They’re Oke Shannon’s notes and you can’t release them until Oke passes away.” So I said, “Okay, fine.” So I’ve held these documents for like twenty years and they’re hand-written documents and they’re inside the UFO working group that John Alexander put out. And Kit Green was [at] the first meeting, Hal Puthoff was there, Ron Blackburn. All these guys with Top Secret SCI clearances, there’s about twenty of them.

And remember when I had it, the rumor got around that I had them. I had shown them at a conference. I just showed the first page that showed it was Top Secret Restricted, which is the same classification as the Majestic 12 document: Top Secret Restricted. So

I put it on the screen, just for half a second, without Oke Shannon’s name on there. And then I get home and then Hal Puthoff contacts me, and Hal says, “I understand you’ve got a list of names of a group that I was supposedly a part of.” And I go, “Yeah, I do!” He said, “Could I get them, please?” So I don’t put Oke Shannon’s name and I leave one other name out and I sent it to Hal. I never heard from him again, so he basically confirmed that these were real. So Eric Davis gives me these notes that are originally from Oke Shannon. So when I’m sitting in the Aquarius hotel, in the front lobby and I look at this document on this little iPad, I see Oke Shannon’s name and I go, “Oke Shannon.” And then I see Eric Davis, his notes and I go, “Oh! Those two guys! This is the whole deal. He had given me the notes before.” And I go, “What the heck is going on here?”

After the leak of the EWD Notes onto the internet, certain researchers contacted Oke Shannon to get him to discuss his role in the meeting between Davis and Wilson. He ended up saying very little—obviously trying to protect himself and his friend. Here’s his statement which confirms he knew both Adm. Wilson and Eric Davis:

“I don’t know the provenance of that purported document—I don’t know whether it’s real or not real,” Shannon said. “Let’s just leave it at the fact that I do know both of these gentlemen. Tom Wilson is an honorable man. And if this has embarrassed Tom Wilson, I am really sorry.”

At this point, we have established that Oke Shannon knew Eric Davis because they worked together on the Advanced Theoretical Physics group. We’ve also confirmed that Oke Shannon knew Adm. Wilson. This makes the statement in the notes that Oke Shannon convinced Adm. Wilson to meet Davis extremely plausible.

The fact that Eric Davis knew Oke Shannon, and he knew Adm. Wilson, is a strong piece of evidence in support of the EWD Notes. I’ll say it again: this meeting happened. This is virtual certainty due to an extremely obvious and in-your-face piece of evidence that most people don’t notice.

Not only did the EWD Notes document leak out of Edgar Mitchell’s estate, but other documents also

leaked out. One of these is called the Alien Autopsy Email Chain document. The document contains communications between Kit Green, Eric Davis, Hal Puthoff, and other members of NIDS. A significant portion of the document contains messages sent by Eric Davis. Examining the two documents, you will see that the style of the EWD Notes (composed entirely by Eric Davis) and the segments of text written by Eric Davis in the Alien Autopsy Email Chain document are almost identical. Both are full of punctuation including very frequent use of brackets, lists, commas, slashes, etc. The two read like they were written by the same author—BECAUSE THEY WERE!

Moreover, Eric W. Davis admits that the Alien Autopsy Email Chain document is real. This makes it plain to see—in addition to all the other evidence—that he wrote the EWD Notes.

Eric Davis on the Alien Autopsy Email Chain Document:

“I saw it yesterday (Leaked Alien Autopsy Kit Green NIDS/Doc). It is not an electronic document. It’s a scanned photocopy of a printed document. And we don’t know who got a hold of it because it’s almost 20 years old. I have no further comment.”

Yet we really don’t need to compare the style of writing used in the two documents, because in addition to multiple “no comments,” Eric Davis has made some fascinating statements about the EWD Notes. The statements are important for two reasons. First, it shows he is concerned about the legal repercussions of discussing documents that may contain classified information. Secondly, he doesn’t flat out denounce the reality of the EWD Notes.

A Statement to UFO Joe (Joe Murgia) from Eric Davis:

(1) that per Tim McMillan’s Twitter posts per the leak from Ed Mitchell’s estate of the so-called Wilson notes, I did not have a lawyer nor did I consult one. I consulted my supervisor and a federal law enforcement/national security professional (who happens to have a law degree but doesn’t practice law) on the perils of publicly commenting on documents allegedly containing classified info., while one has active clearances.

A transcript of Eric Davis answering questions on The Basement Office with Steven Greenstreet about the EWD Notes:

SG: *Let me bring up . . . before . . . we’re pressed for time . . . tell me about the Admiral Wilson transcript.*

ED: *I can’t discuss that.*

SG: *You can’t discuss?*

ED: *I’m not at liberty to discuss it.*

SG: *Because you’re all over . . . you’re all over it.*

ED: *Oh, I know. Yeah. They were leaked out of Ed Mitchell’s estate and there’s nothing I can say about it.*

SG: *I mean, can you speak to the veracity of them?*

ED: *No, I can’t, I can’t address that at all. I won’t answer any questions on the Admiral Wilson notes.*

SG: *You don’t wanna speak to . . . at least whether these are . . .*

ED: *You know, they’re purportedly classified information. I can’t . . . I’m not at liberty to confirm or verify any aspect of those notes. You know, when you have security clearances, that’s something you don’t want to violate because the Department of Justice—under the Obama administration and it’s continued under the Trump administration—policies, is they will vigorously prosecute anybody with security clearances who will go out of their way to discuss any classified information that got leaked or released into the public illegally, so . . . or through other means.*

SG: *Okay.*

ED: *So I can’t address those notes in any form or fashion.*

SG: *So, Canadian Grant Cameron uploaded fifteen pages of documents (We still don’t know who uploaded the documents. ~Joe), allegedly notes taken from Dr. Eric Davis in 2002. So, whoever this Grant Cameron is . . . are you familiar with who this person is?*

ED: *Oh, I used to know him. Yeah, he’s a Canadian UFO investigator. He doesn’t investigate UFO phenomena, what he investigates is . . . his big claim to fame was investigating the U.S. president’s role in the UFO history.*

SG: *Where did he get these fifteen pages from?*

ED: *I don’t know. I’ve never seen whatever the pages are that he has. I haven’t seen those.*

SG: *Like, here is a . . . what appears to be a letter to you from a . . . Will Miller?*

ED: *Ah. Okay. All right. Well, he uploaded it but I can't address any of it, so.*

SG: *All right, so is that a yes, these are real, these are true?*

ED: *I won't, I won't give you an answer (laughs).*

SG: *Okay. All right, I guess that's enough of that.*

If the meeting between Davis and Adm. Wilson never happened, the EWD Notes document would be a total, absolute farce. Even if he did not want to discuss nitty gritty details such as crash recoveries of ET craft, there would be ZERO repercussions from him stating, "I've never met Admiral Wilson and the meeting described in the document never happened." Also, everyone who knows Eric Davis has stated he will call out anything he considers to be BS. If someone was passing around a fake document about him claiming an event took place that never happened, he would denounce it. Yet he has not. Instead, he has made statements which make it seem like he is trying to convey the fact the meeting did happen.

Certain parties have tried to say that UFO enthusiasts are being irrational by taking his no comments (which sometimes are much more than a simple no comment) as a "yes." The reality is that Eric Davis is an extremely intelligent man, and if the notes were a hoax, he wouldn't make comments that would make people believe they were real. Instead, he'd say that the meeting never happened and the whole issue would be settled. Or, if a few diehards still felt that the meeting happened, he would say something like, "people can believe whatever the hell they want but I never met with Adm. Wilson."

The reality is that no one that was in NIDS or TTSA has said or conveyed anything that would dismiss the reality of the meeting. What *has* happened is that multiple individuals have provided weird public statements that have had the opposite effect.

There have been slip ups, though. The well-respected scientist Dr. Harold Puthoff, Eric Davis' former employer, answered a question at the end of a long presentation and stated the outright truth—obviously because he was exhausted. He admitted that Eric Davis did meet with Admiral Wilson. In fairness, he does claim that he was only repeating the question he was asked, but he's only saying that

because it's required if he wants to protect his security clearance (which is one of the longest held in the history of the United States).

Question and Answer about the EWD Notes (Hal Puthoff answering):

Q: *Richard Dolan calls the Wilson Documents . . . the Wilson document leak, the leak of the century. Can I get a comment on the Wilson Documents?*

HP: *This is a question about the Wilson Documents that apparently got leaked on the internet. Admiral Wilson, who was one of the Joint Chiefs of Staff interviewed by my senior scientist colleague, Eric Davis. Since it discusses potentially, ongoing programs, I have no comment.*

George Knapp is another individual who has been willing to go on the record stating that the EWD Notes are real and the meeting between Adm. Wilson and Davis happened. Being very close to the entire NIDS group, he knew the personalities of the people involved and states frankly that Eric Davis would not make stuff like the notes up and have the audacity to hand it to Robert Bigalow. These were not silly UFO buffs getting together after a convention or Roswell UFO parade getting beers and making up tall tales. They were serious people, doing serious work, with serious accountability.

"I'll just tell you this. I think that this . . . I am fairly certain that this is an accurate representation of a meeting that really did happen. It was typed up not to distribute it to the public, but to share with the very tight group of professionals and the NIDS Science Advisory Board. Among them was Dr. Edgar Mitchell. It looks like Dr. Edgar Mitchell after he died, his personal papers got in the hands of members of his family, and then dribbled out to the UFO community, and I think is where this came from. This meeting happened. Admiral Wilson denies it. I think he'll always deny it. Dr. Eric Davis is not somebody who makes this stuff up. He certainly doesn't make it up and then hand it to his boss Bob Bigelow in the Science Advisory Board made up by the whole clout. You may not believe that the contents of what is discussed in this meeting is true, and we have no way to verify if all this is true or not. But did the meeting take place? Yes, it did and this memo is an accurate reflection

of what happened. I think that . . . remember we at the beginning of this podcast we talked about The New York Times poking around. Part of what they're poking around about is this memo. Is it true? Does somebody have metamaterials stashed in the hangar somewhere or in a lab? Are they investigating it or they are trying to figure it out? It's the most enticing part of the UFO mystery other than who are these beings, and where they are from, and why are they here. If you can have physical evidence that it came from somewhere else, that we are taking apart, and trying to figure out how it works, that's an indication it's not ours. It came from somewhere else. And that is sort of the holy grail. That would change the whole debate. If The New York Times goes ahead with that story, even if they are unable to prove it definitively, that's a really big deal." —George Knapp

Another individual involved with NIDS has made statements that confirm Adm. Wilson located the SAPs, was denied access, and much more. This is the astronaut Edgar Mitchell. If you look through the extensive collection of comments he has made, you will see how he has made some stunning admissions. Most importantly, he even states that a colleague of his with a security clearance met with the admiral in Las Vegas. In another, he mentions receiving a report which we now know was the EWD Notes.

"Subsequently, another contact of mine, who must also remain nameless because he's on classified programs, encountered the Admiral in Las Vegas, where he had been looking for and trying to get into the so-called "strategic access program" around the UFO incident and had been denied." —Edgar Mitchell

We also know that someone within the NIDS network showed a couple pages of the document to Richard Dolan in 2006 and provided enough background information to indicate that the document was indeed serious and not any kind of hoax or movie script. The evidence that Richard Dolan had this experience long before the EWD Notes leaked is that he talked about the experience of meeting an insider that conveyed information to him about this issue on the *Paracast* program in 2007.

Melinda Leslie is also someone who has questioned insiders about the validity of the EWD Notes. In a private conversation with Jim Semivan of TTSA, she asked multiple times about the notes and gave him many opportunities to denounce them. However, he didn't. Instead, like others that were connected to NIDS or TTSA, he issued his own strange no-comment.

For the sake of brevity, the bulk of the evidence in favor of the reality of the EWD Notes will be skipped. The meeting happened. There can be no reasonable doubt as to the fact that Eric Davis met Wilson, afterwards wrote down what he remembered, and distributed it to a very small number of trusted colleagues (most of whom if not all had security clearances) within NIDS. This was not him betraying his nation or his oath. Eric W. Davis already knew the UFO cover up was illicit and extra-legal with the truth being withheld from countless elected officials with a right to know (due to their decision-making responsibilities) and military leaders (who would have a need to know about an extraterrestrial power flying in our skies and under the oceans). Likewise, Adm. Wilson discovered that these reverse engineering programs were actually hiding behind official carved out, waived, unacknowledged SAPs and were not disclosing their nature and budget transparently in the official database of the Office of the Under Secretary of Defense for Acquisition and Technology (OUSDAT). Instead, the leadership team of the Senior Review Group was allowing them to hide out without their honest and accurate information being available in the index of all SAPs that would normally be available to the ENTIRE Senior Review Group.

This was breaking the letter and the spirit of the law. Worse, it was potentially putting the United States and the entire human species at risk because the subject was being kept under the control of small groups in private corporations instead of democratically elected officials. This travesty needed to be corrected. Eric Davis and Adm. Wilson both recognized this. To have any hope of eventually seeing a correction take place so the topic could be handled within the confines of the United States constitution, Adm. Wilson knew he had to get the information out and Eric Davis recognized he would require the

assistance of his closest colleagues and associates. These two men behaved as true patriots: unlike the members of the Senior Review Group that threatened Admiral Wilson if he didn't drop the issue.

Eric Davis may have already known a great deal about the UFO cover up before meeting with Adm. Wilson. However, it's plain to see that if he had any lingering doubts about reverse engineering programs working on recovered ET hardware, Adm. Wilson erased them. Already having had UFO sightings and mysterious experiences at Skinwalker Ranch and elsewhere, he knew there was a reality to the subject. But what Wilson had to say cemented it in place and created the solid foundation for the events that were to come in subsequent years. Admiral Thomas Wilson had been an outsider to the corporations that control the UFO topic, but soon Eric Davis would meet an insider that would let him get a peek beyond the veil.

The Insider

In the time period of a year or so before the Adm. Wilson document leaked to the world, Eric Davis gave multiple interviews on the radio and on internet podcasts. He made many bold claims, including that UFOs/UAPs were absolutely real, non-human craft with radical propulsion systems that manipulated the fabric of space, Roswell was indeed the crash of an ET craft and a stupid coverup, and a series of additional crashes took place. Obviously, he had a lot of knowledge that he wanted to share with the world.

A great deal of this information came from him checking out the claims of insiders like the late Col. Philip J. Corso (whose claims he had completely verified), networking with the former membership of NIDS (including people like Kit Green who have had fascinating experiences of their own), and working for Hal Puthoff who was a subcontractor for AATIP. If you listen carefully to his interviews and connect different pieces of information he provides, you will discover another source of information that would have had more knowledge than Adm. Wilson. This individual is the insider that read him into at least one of the many UFO reverse engineering SAPs that span the private sector.

Here are the basic details that Eric Davis shares in his interviews. To get all the pieces of information, you need to listen to multiple podcasts.

Davis knew a former retired vice president of a legacy aerospace corporation, which he flat out stated was Lockheed Martin during an interview on Coast to Coast AM. After years of working hard to make connections, Eric Davis met him, whereupon this individual revealed he used to work on a reverse engineering program. As this man was a former executive vice president of Lockheed, it's logical to guess he would have had a leadership position.

Eric Davis states this was a program from the 80s that shutdown in 1989, apparently due to two factors. First, a lack of significant progress in figuring out the technology. Second, that there were individuals in the DoD and government who felt the entire UFO subject was demonic. Davis makes it clear that these very small clusters (one, two, or maybe three people) in positions of power can shut down programs in the tracks. He recounted how a three-star Air Force general once told this individual that patriotic Americans don't want to have anything to do with demonic technology. Apparently, this individual read Davis into the program to a degree we cannot be certain of. It's clear that at a minimum he was told that a large number of crash recoveries have happened, but Davis does state that he is aware of crash recoveries the public doesn't know about that he cannot comment on.

I will provide quotes that back up what I've stated above. However, let's look at the implications of the above.

A) IDENTITY—Since Eric Davis was read into such a program, he would have information about the identity of a vice president of Lockheed that managed a reverse engineering program. He'd also have some information about the identity of the program itself, depending upon the extent that he was briefed and read in. If he signed NDAs or security agreements, then he would possibly have codenames and other information that he could provide to key leaders in the U.S. Congress and Senate that could identify the reverse engineering programs. Literally, Eric Davis could be an incredibly important person

due to this briefing—perhaps equally as important as Admiral Wilson.

B) REASON—Why would they brief Eric Davis on such a UFO program or read him in? Part of it could be that he was an extremely competent scientist deemed trustworthy and who happened to be working on a UFO program himself (working for Hal Puthoff who was a subcontractor for AATIP). However, it seems to me that his experience with Adm. Wilson probably played a role in their decision-making process. The knowledge he gained from Wilson could have been a key that unlocked this door. But there could have been other sources of knowledge that we don't know about that also helped.

C) PROGRESS—This individual told Eric Davis that one reason they were shut down was because of a lack of progress in figuring out the ET technology. I find this plausible if their program only had access to one or a few recovered ET craft that utilized sophisticated meta-materials. One idea that has circulated around the internet is that some UFOs utilize hulls composed of precisely engineered layers of different elements and isotopes that work to manipulate the Zero Point Energy field and fluctuations to control gravity, perhaps by the production of what's called "negative energy." An example of "negative energy" is the zone of reduced density of virtual particles and virtual fluctuations between the two plates of a Casimir Cavity. The science of Casimir Cavity design is extremely complex and involves a great deal of material science, including issues such as engineering materials with a desired reflectivity, optical transparency, plasmonic devices on the surface of the plates (surface plasmons or electron waves dominate the Casimir Effect at short distances), and a host of other factors. Today it's possible the SAPs have had some progress replicating such a craft. Thirty, forty, or fifty years ago it could have been impossible. Now, with our advanced lithography technology and understanding of meta-materials it could be possible.

There are a couple of other possibilities, though. Since we know from Eric Davis and other sources that there have been multiple crash recoveries, it makes sense that they utilized different propulsion

systems (all manipulating the vacuum to control inertia/gravity in a different way). For example, "coherent matter" (or matter in which all the atoms share the same phase and have the same energy and thus become more like a Bose Einstein Condensate) is thought to interact "coherently" exchanging energy and momentum. One way of producing coherent matter is to produce a self organized plasma that can develop a layer or membrane of electrons on the surface that exist as coherent matter. If one or more UFOs that were recovered utilized an internal reactor that produced a self organized plasma, this may have given OTHER Special Access Programs or even completely private programs with ZERO funding from the DoD the knowledge to build craft like the Fluxliner Alien Reproduction Vehicle.

The Fluxliner Alien Reproduction Vehicle or ARV was a craft allegedly witnessed by Bradford Sorensen, a friend of the late Mark McCandlish, at Lockheed's big hanger in the 1980s. To learn all the details, check out the awesome documentary, *Zero Point: The Fluxliner ARV* documentary on YouTube, which was made by a film student named James Higgens. At the Lockheed hanger, Bradford Sorensen saw three different sizes of Fluxliners while a general talked about them and a video played of a craft in operation. Eventually, Mark McCandlish formed a very loose group that investigated the claims of Bradford Sorensen and looked for additional verification. Although perhaps no absolute proof was found, Mark McCandlish found additional witnesses who had seen the Fluxliner and similar craft in other circumstances. He also learned from alleged insiders that one component of the craft's propulsion system was a central column with a self organized plasma of mercury vapor, allegedly the specific isotope Mercury 199. This isotope seems likely to have been ideal for a number of reasons, including it being a single isotope and having a one-half integer spin that would eliminate any quadrupolar movement (which would shorten the spin relaxation time). If Brad Sorensen and Mark McCandlish's other witnesses are being truthful, and the Fluxliner utilizes such a self organized plasma, the coherent matter layer may have a greater impact on the ZPE (zero point energy) fluctuations or the superfluidic aether than ordinary

matter and a “warp field” around the craft could have been produced.

I find it likely that even before metamaterials (except perhaps Barium Strontinum Titanate, which was around during that time and may be considered a very early form of meta-material due to its non-linear characteristics and extremely high k factor) would have been understood, aerospace companies may have harnessed self organized plasmas to mimic the field configuration of UFOs. If so, the vice president of Lockheed who read in Eric Davis may not have been aware of other programs with craft utilizing coherent matter technology. Another possibility is that he was aware, but didn’t want to tell Eric Davis because he didn’t even consider it related to his specific program.

Just because this individual told Eric Davis that there had been very little progress doesn’t mean there wasn’t. He could be omitting information intentionally or unintentionally.

Eric Davis may or may not have been allowed to see any ET hardware, vehicles, or bodies when he was read into the Lockheed UFO reverse engineering SAP, but the irrefutable knowledge he gained that such a program existed was priceless. He discovered not only that we are not alone in the universe and that ETs are visiting our planet, but that we have a significant number of their vehicles.

Each of these represents a “get out of the fossil fuel age free” card. From a single ET device a company could discover electronic components, new materials, circuit designs, and perhaps even stores of information. Possessing entire vehicles takes this to another level! This is especially true if there were survivors that the government interacted with and learned from.

Moreover, if there really were landing events — such as the Holloman Air Force Base landing in which some sort of diplomatic negotiation or an exchange program took place—the significance climbs exponentially. Knowing that Eric Davis brought up such landings in both the Alien Autopsy Email Chain document, we should listen carefully for anything he has to say on the matter.

Grant Cameron has also indicated that in the past, individuals from NIDS were extremely interested in the Holloman AFB Landing, and he

provided them with information that he had collected. What does Eric Davis know today about these landings? Interestingly, he has commented by saying that there have been recoveries of both crashed and landed craft. If the Holloman AFB Landing happened, could the ETs have given the United States military one or more vehicles? Did he ask any questions about this to the vice president of Lockheed who read him into the crash recovery program?

Here are the various statements from different interviews in which Davis discusses being “read in” by his friend who was the vice president of Lockheed. Please note that if you take all of his statements as factual, there’s only one story that is revealed if you put them together: he really was read into a Lockheed reverse engineering SAP.

Coast to Coast AM with George Knapp:

Quote #1: *I also know that a retired vice president of Lockheed Martin himself, he and his family, had a UFO encounter on the coast of California and the craft they saw was a bit of a modified version of a TicTac in that it came to almost a point on one end and it had an unusual light pattern. And this guy had came up through Lockheed Martin working for Ben Rich at Skunkworks and he told me that he knows all the advanced secretive aircraft and UAVs that are developed by China, Russia, Iran, and North Korea and all of the American ally nations as well as non-aligned nations that are not our adversaries. And he said he knows through intelligence information he gets briefed on what the aircraft configurations and performances are, how they are lit up, etc., etc., and he said that this thing he and his family saw looked nothing like it. It absolutely behaved and flew in the sky like nothing he had ever seen before, and he came up through Skunkworks working for Kelly Johnson, I’m sorry, Ben Rich, I’m sorry, it was Ben Rich. And so that is an example of the variety of shapes and if you look at . . .”*

Quote #2: *And they have not been investigated to my knowledge. I’m sorry, they have not been revealed or published, to my knowledge. So, without knowing that that’s the case, I won’t talk about it any further. But we have crash retrievals and they’ve been analyzed and unfortunately, our laboratory diagnostic*

technologies and our material sciences and the understanding of physics that we had, were not advanced enough to be able to make heads or tails of what it is, what they had their hands on. The customer, being a certain government agency, decided to just pull the plug on funding so that was the end of it.

Eric Davis interviewed by Erica Lukes (available on YouTube) [[youtube.com/watch?v=gtF42lXrsDg](https://www.youtube.com/watch?v=gtF42lXrsDg)]:

“They can deny it. They can stop it in their tracks because they have religious prejudices against UFOs and they simply . . . One three-star Air Force general told somebody I know at a major legacy aerospace corporation once on this particular topic and it has nothing to do with BAAS or the AATIP program this is a historical program dating back to the 80s and he basically told this vice president patriotic Americans don’t want to have anything to do with demonic technology or Satan because that’s going to lead to their downfall. You know patriotic Americans want to stay away from the Devil.”

Eric Davis interviewed on *Open Minds* with Alejandro Rohas.

Quote #1: *So, it takes a lot of hard tracking and digging after networking, and it can take years and years and years. And then you develop the security clearances and then the authorization for need-to-know that appropriately allow you access to that information. Then you find out, “Hey, yeah. It’s there, it’s true.” On the other hand, sometimes the information does come out on its own but it doesn’t come out in the way that UFOlogy likes to fantasize about it. It comes out only to specific people who have specific talents and skills, who have security clearances. They may not have the need to know, but they could have the need to know if they were presented with that requirement or if they were presented by a crash retrieval program and saying, “Hey, I want to bring in gentlemen X, Y, Z. He’s got the security clearances, but he doesn’t have the need to know, and I want to give him the need to know because I need his talent to help us solve this problem with the crash retrieval reverse engineering studies. So, then they will do that. That’s the official way of doing it. That’s how you officially get brought in.*

The other unofficial way is . . . you gain, you build a level of trust among certain individuals, and people within the network who, after a few years of knowing them, you work with them, they know who you are, they know what you’re capable of, they know your competencies. And they want to bring the topic up on an informal basis with you. Sometimes not even on an informal basis, they may want to bring the topic up outside the realm of the security apparatus but, within a SCIF. In other words, there’s going to be no passing of security clearances to establish that I am going to be allowed to be read in on the crash approval program, but they’ll bring me into a SCIF and want to talk informally in the SCIF about it. And say, “Well, this is what we can tell you but there’s things that we can’t tell you. And we can tell you those things if you can get the next level security and authorization to get the need to know and then we can do business with you. But before we get to that point, here’s what we can tell you without having to cross that red line of the need to know and the proper clearances.”

So, you work this stuff out over a number of years, you build networks, and you find the right people. And you don’t do it by knocking on doors, you do it just through the happenstance of having a contract with somebody or a subcontract. And you’re interfacing with them. And then, lo and behold, you find out they’re the vice president or the president of one of the legacy aerospace corporations and they happen to be a PhD of a STEM discipline all on their own accord. And it just so happens that they were a guy that worked on the crash retrieval program. Oh, lo and behold! And then they find out that you’re working the UFO subject for a DoD program. And they’ll say, “Oh, that’s wonderful! You’re officially a government contractor or subcontractor. And you’re working with another aerospace company. Okay, well you’re working on UFOs? Well guess what? We did it too! And we don’t do it now, but we did it in the past and here’s what we can tell you, off the record, and here’s what we can’t. And you’ll have to go another step before we can tell you what it is on the record. But it has to be through that, again, you have to have the right clearances, you have to have the authorization for the need to know, and then you can get the full story.”

Quote #2: *So, here's the thing that you should know . . . is that the crash retrieval program is [a] very small program. It is not a massive, huge government infrastructure. It's a, it's a very poorly funded program and it hasn't actually, probably hasn't had any money for a while. I do know that the program was terminated in 1989 for lack of progress in reverse engineering, anything that they had, any of the hardware that they had. And they'll resurrect it every, maybe so often, so many years go by, and they'll try it again. And they just don't succeed because compartmentalization is a killer. Scientists cannot communicate with other scientists to get help.*

Quote #3: *Yeah. And this isn't just unique to the crash retrieval program. This type of problem is unique to all the black programs that the DoD has. DHS has them. The military service branches have them. The Department of Energy has their own version. The purpose of a black program with a special access program security wrap is you [need to] limit the information and exposure to the information to as few people as possible in order to produce the maximum security protection against espionage by the enemy. And so that limits who you can work with, [who] also is cleared to know. That limits the amount of experts that you can have working with you. And gosh, if your small group of experts are stumped, you're screwed, because you basically can't call your buddies or somebody you know, or somebody you know of, who's an expert better than you or a bigger expert on the subject, at a university, either near you or at a university across the country. You can't call those guys, you can't even read them in because you're not supposed to acknowledge some of these black . . . most of these black programs are not supposed to be acknowledged.*

So, for that basis, you don't legitimately exist, so you can't tip off the university expert that there's a program, by calling him and saying I'm stuck on something, you just can't do it. If it's really dire and it's a problem that really, the expertise is desperately needed outside of the cleared group, then the program manager and the security officer will write a justification to go reach out to the university expert and read him in on the program and they'll have to be given security clearances and sign the NDA and fill out the

SF-86 and all those forms and get the DD 254 filled out. And then they'll be told, you die with this information. You can never talk about it until after you die. (laughs) Till after you're dead.

Quote #4: *So that's how that works. And it happens in cruise missile programs, it happens mostly in programs involving covert, clandestine operations and their logistics. It happens with nuclear weapons development and deployment. It happens with intelligence operations, and it happens with technology development. And the interesting thing is that today, there's a big move away from Special Access Programs. They're extremely costly to maintain. Extremely costly. Let me tell you this: The cost to maintain information, personnel and physical security for special access program can be tens of times larger than the cost of the program itself. So let's say the program is building the B-2 bomber, right? Let's just assume, let's say for the sake of argument, that the bomber project is \$50 billion total. That's probably not even reasonable. The security for that is going to be, could be as much as ten times higher. I mean, it could be. Stretched out over a number of years, of course, not all at once. So it could be as much as ten times higher because you've [got to] maintain all kinds of security. Now that's a hypothetical.*

The Benevolent Collaborator

After having a range of experiences that seem to have given him insider knowledge of not only crash recoveries, possible landings such as at the Holloman Air Force Base, and reverse engineering programs, he recently landed a job at the Aerospace Corporation. This company, which is almost like a government agency, has deep connections with other aerospace companies like TRW, Hughes Aircraft, and others. I'm unaware of his official position at Aerospace Corporation. It's very possible that 100 percent of what he does is ordinary, mundane work at least when placed beside investigating UFOs for NIDS. What I can't get out of my mind is the possibility he took the position for a reason. By accepting the job, he was gagged from giving interviews or talking about UFO-related issues. Since he obviously enjoys discussing UFO-related issues, why would he accept such a position when he'd be restricted from doing what he loves?

The only possibility I can come up with is that by going to work for Aerospace Corporation there is a chance he could have also gained an unofficial position or job doing reverse engineering work. Or, if not working on actual ET hardware, perhaps he is involved in development of space technology that can be used to monitor both UFOs and foreign adversaries. Could he be processing data from satellites to look for fastwalkers? I also can't help but think about The Zodiac Project or "Zodiac."

Multiple sources, including the fictionalized story written by an individual using the pseudonym "Greg Halifax" for *UFO Magazine*, speak of a UFO program called Zodiac or "The Zodiac Project." This project was even mentioned in the Alien Autopsy Email Chain document. Hal Puthoff asked Kit Green if he had read the story and if he had heard of the project. Interestingly, Kit Green's answer was "snipped" away (not included) and only a different question was answered. Recently, Lue Elizondo has admitted to being aware of Zodiac, but has refused to comment.

In the EWD Notes, Eric Davis mentions a woman named Mary Elizabeth Elliot that had some kind of issue with the aerospace corporation TRW and had an attorney named Jeffrey W. Griffith. Interestingly, Aerospace Corporation has connections to TRW. The history is fascinating and can be found with a quick search. Could it be that Aerospace Corporation had a UFO reverse engineering program? If so, could Eric Davis have gotten a job with them to try and gain access to that program? By now any such program could have a completely different name, but it might still be around. Being able to actually see, touch, and explore an ET craft and possibly even "humanoids" might well be something that could make Eric Davis accept the restrictions placed on him by Aerospace Corporation.

Let me be clear. I do not know if such a program exists or if Eric Davis is working for it. What I do think is that factoring in his life experiences, encounters with people like Adm. Wilson that confirmed the reality of crash recovery programs, and his career history with NIDS/Earthtech, he would have probably looked for a job with connection to the UFO subject. After you know that there are ETs

flying in our skies manipulating the most fundamental forces of nature, working on even the most advanced jet fighter or satellite system might seem a little dull.

Regardless if Eric Davis is currently involved in a reverse engineering program or not, he's collaborating with the forces that wish to maintain the atrocity that is the UFO cover up. By not going public and sharing the details of his knowledge of the greatest lie ever told (NOT GENERALITIES LIKE CRASHED HAPPENED BUT ACTIONABLE DETAILS WITH PROGRAM MANAGER NAMES, PROJECT CODE NAMES, DETAILS FROM MEETINGS WITH PEOPLE LIKE ADM. WILSON) he is prolonging the deception. I believe this is fundamentally wrong.

The information being withheld is not only the right of every sentient being, but its concealment is also preventing the broad adoption of technologies that could reduce human suffering, allow humanity to overcome the challenges facing us, and take humanity to the stars. At the same time, after everything I have read and listened to, I believe that he isn't collaborating maliciously, but benevolently.

Eric W. Davis is opposed to the UFO cover up. This is undeniable. He has shared significant information online with the UFO community, pushing as close to the line of leaking classified information without stepping over. If you listen to his interviews, he has tried to convey everything he can to let the world know that crash recoveries have occurred. He has reasons for not giving out the ACTIONABLE details that could be used to push disclosure forward rapidly: he has a career, he has a family, he has a security clearance. He has worked hard to support and build all of these three things. If he spills all the beans, he could lose his highly coveted, hard to get security clearance, lose his job, and therefore be less able to provide for his family. In the absolute worst case, there could be legal repercussions. Additionally, people have told him things in absolute confidence in which they likely made him give them a personal promise in addition to or instead of signing a piece of paper. As an ethical individual of a high quality of character, he'd think extremely hard before breaking such a confidence.

Attempting to put myself in his situation, I can imagine that he may think that by temporarily collaborating, holding back the actionable information (at least from the public because we don't know what he has said to key congressmen, senators, investigators, and military leadership) he could work for disclosure from the inside out. Perhaps he thinks that he can influence the programs and organizations hoarding UFO evidence to do the right thing and share what they know with the world. Even if being new to the program he may not have that influence from the start, he could potentially acquire it over time.

I could also see Davis hoping that Lue Elizondo's efforts to establish a permanent UFO office, convince the inspector general to investigate the SAPs with UFO hardware, and to increase transparency could lead to a situation in which he might act as a liaison between one or more corporate SAPs and the DoD. He has all the qualifications for such a position including the military background, intelligence training, scientific proficiency in related areas (warp drive physics, zero point energy, etc.), and has already had meetings with congressional staff. Although I would really like to see Hal Puthoff involved, I cannot think of anyone better to stand in the gap to facilitate cooperation between a permanent UFO office and the private corporations hoarding the hardware.

I don't think the above scenario is extremely likely, though. I honestly don't believe these private corporations and perhaps associated organizations like MJ-12 will cooperate. They have nothing to gain financially from disclosing the fact they participated in the greatest deception in human history. As soon as they share the ET hardware (even if they don't show off their own anti-gravity craft) there will be a global race to build anti-gravity craft simply because every nation and corporation in the world will know it's possible. Manipulating the fundamental forces of the universe and extracting energy from the vacuum would no longer be science fiction but hard reality.

The secret that I firmly believe these SAPs wish to suppress more than anything else is that although the meta-material-based craft may be more challenging to replicate, there are designs that are relatively EASY to build. Utilizing self organizing plasmas

with coherent matter layers that can interact with the vacuum (acting as the universal clutch described by Kenneth Radford Shoulders) any country would be capable of building craft that could both tap energy from the vacuum and warp space.

In a short time period, all the US corporations such as Lockheed would become irrelevant. No longer could they make incremental improvements in jet fighters, satellites, or stealth technologies and earn billions of dollars. Instead, they'd have to compete with hundreds of other companies building vehicles that would rival those from the varied works of science fiction. Bus-sized vehicles capable of going to Mars in hours could become the norm and every aspect of human civilization would change.

Why do I think there are configurations for anti-gravity vehicles that would be relatively easy to build? I believe this primarily for two reasons: the evidence for the Fluxliner ARV and the work of Kenneth Radford Shoulders among other inventors such as Eugene Podkletnov who have produced devices that can manipulate gravity.

In short, Kenneth Shoulders was a successful inventor and engineer who in the 1980s decided to find a truly exotic project to work on. He decided to work on electrical discharges and teamed up with Hal Puthoff and Bill Church of Church's Fried Chicken, who provided the funding. It turned out that when he pulsed a sharpened cathode with electricity, the sudden out-of-equilibrium, non-linear conditions would induce the formation of a self-organized structure out of the ions, electrons, neutral particles, and metal vapor from the destruction of the sharp tip.

This structure had surprising properties. One of the most important was its ability to act as a miniature warp drive. These toruses or spheroids could capture matter and accelerate it for very low energy because they were somehow producing a field that negated their mass and inertia. He built many devices (they were very small) producing micron-sized "Exotic Vacuum Objects" that could be slammed into an anode resulting in a release of anomalous energy. The story is long and fascinating, but suffice it to say he had some sort of falling out with Earthtech while maintaining friendships with people like Hal Puthoff.

Many years later, Eric Davis wrote a paper for Edwards Air Force Base Research Laboratory about ball lightning, titled, “The Ball Lightning Study.” In this study, he discussed many different aspects of ball lightning and proposed a program to reproduce a classic Kenneth Shoulders EVO generator. Although we have no official confirmation that such a program ever took place, the late Mark McCandlish received word from a scientist friend who visited the AFRL and was shown the device. He was told that it produced small amounts of energy that were anomalous but they didn’t know how to scale it up. Mark McCandlish asserted that he discovered that before Eric Davis could write a report on the program, it was classified.

Interestingly, Hal Puthoff and Eric Davis are both consultants to “The SAFIRE Project,” a Canadian company that has built a reactor that produces a self-organizing plasma that wraps around a central anode between two cathodes. Long story short, it produces huge amounts of excess energy and other anomalies such as transmutations that are found on the surface of the anode that extend all the way to the center of the sphere. Moreover, they’ve used a company that a consultant from Lockheed Martin suggested, and this company confirmed the transmutations they detected.

In regard to how this technology could relate to gravity control, the director of The SAFIRE Project, Monty Childs, has made a statement that they believe they are detecting the shielding of matter from gravity between the double layers of their plasma. This would make perfect sense if the double layer, when it collapsed close to the anode, was creating a form of “coherent matter” that would block zero point fluctuations.

Thus, Eric Davis would already have unique knowledge of a breakthrough energy and possibly a gravity control technology that he could utilize while studying ET hardware, if he were given the opportunity by one of the SAPs. He would not be a random scientist with nothing to contribute. With his knowledge of zero point energy and EVOs, he could help them understand the various types of craft that had been recovered and how they are able to propel themselves.

Here is a post from Kenneth Shoulders in response to Jack Sarfatti about how EVOs act like miniature flying saucers.

These mesoscopic EVOs are tiny “flying saucers” with warp drive in some cases, i.e., observed anomalous self-acceleration.

A typical EVO charge cluster is 10^{-4} cm across with a total charge of Ne where $N \sim 10^{11}$.

Exactly how the vacuum coherence $\sim \text{Tr}(K)$ is tweaked is not clear yet in this phenomenon, but that it is so tweaked is the only plausible explanation for the observed facts.

One way to test this EVO hypothesis is to look for an anti-gravity blue shift of a sharp spectral line of a quantum jump in the interior of the EVO if the zero point pressure is negative or a gravity red shift if the zero point pressure is positive, since the effective short-range $G^ \gg G$ here.*

Ken

Yet not all of the consequences of disclosure are technological. Humanity would learn that we are not the only sentient life in the universe. Conversely, we would learn that we’re one species of small fish in a vast ocean of larger creatures including octopus, sharks, stingrays, jellyfish, turtles, dolphins, seals, and more. The mindset that makes humanity war against each other, inducing tragic human suffering and wasting resources, would change leading to a different planet. Again, this wouldn’t be good for corporations that make their fortunes selling weapons and tools for warfare.

If we want disclosure, true patriots, like Admiral Wilson, Eric W. Davis, Lue Elizondo, and multitudes of others with critical, actionable information that could identify and expose the reverse engineering programs, must come forward publicly and share what they know. The idea of working within the system or playing nice with the corporations and parties that have maintained this cover up isn’t realistic. As a permanent UAP investigative office is established, these parties will bury the programs deeper, shred the last of the paper documents that explain the long history of suppression, incinerate the extraterrestrial bodies, delete electronic databases, and erase all the evidence that their programs existed.

This erasure of history would be virtually as tragic as the UFO cover up itself has been. Yet I fear it's likely if people with actionable, useful information go for a slow drip feed disclosure in order to play by the rules. The UFO cover up sure hasn't abided by the law, the spirit of the law, or even basic democratic principles. By suppressing the truth, they set themselves up as the controllers of humanity. They've kept the world ignorant about the reality of multiple forms of other intelligences, extraterrestrial life, the exotic technologies that could save humanity from a bleak future, and even spiritual truths about our immortal soul that exists forever. They're the bad guys. They're the villains.

What we need right now are benevolent good guys with hearts that care about the future of humanity to share what they know, immediately. They should take a little time to work on the most effective way to do so, but they shouldn't wait until nearly mythical congressional hearings happen or corporations like Lockheed suddenly recognize the error of their ways and report everything they know to the UAP Task Force. If these organizations have kept their secrets for seventy plus years, they have a huge amount of inertia and there is very little chance they'll stop willingly.

Every congressman, every senator, every military leader, and every citizen of the United States of America needs to hear the truth simultaneously. Only when the CORE SECRETS are put out there INDUCING FAILURE of these programs that have operated for decades in secret without oversight will disclosure happen. It's going to take such a revelation for politicians who care far more about their career and getting re-elected to raise their voice and start publicly making demands of these corporations to share everything they know.

Disclosure is not a process. A thousand additional videos of UAPs spotted by well-trained pilots won't do anything but increase the amount of chatter online and perhaps convince a few more journalists to start discussing the issue. Only the revelation of crashed or landed intact craft with non-human bodies or survivors will end the cover up. Once freedom-loving individuals who believe that the government is supposed to serve the people instead of serving as the Ministry of Truth take the leap, share

what they know, and force the government to admit to such incidents, then disclosure will happen.

Until then, the debate won't ever get settled and debunkers will continue making phony arguments. As soon as the truth about crash recoveries is revealed, all of this will change. One intact vehicle along with the exotic materials it was composed of, the devices it contained, and the occupants that were found will induce a global paradigm shift. This irrefutable evidence will wake people up to the fact that multiple forms of non-human intelligence are visiting our planet, the science of engineering the vacuum allows for real-life technologies that rival the wildest science fiction, and that we live in a vibrant universe that is worth exploring and discovering.

Moreover, this will prevent the citizens of the U.S. and other countries from paying repeatedly to obtain the same answers. Although the crash recovery and reverse engineering programs have certainly not figured out everything, they have learned a lot. With billion-dollar budgets and nearly eighty years, there are encyclopedias of information they could share with us. These answers shouldn't be suppressed simply because the fact these programs existed is embarrassing to the military or the corporations. The truth needs to come out, now. If various agencies need to issue repeated apologies for their part in this massive cover up, so be it. What matters is that the deception ends, and the full history is revealed.

Everyone with insider knowledge has a choice to make. There are basically two options.

1. Work from the inside out to expose the cover up, supporting the drip feed while over the next ten to twenty years the entire history of the UFO crash recoveries, reverse engineering programs, landings, and potentially even exchange programs and diplomatic negotiations are erased—lost to the ages to protect the image and reputation of various agencies and corporations. This doesn't result in full disclosure but a twisted, spun, and politicized version that best suits the interests of those in power.
2. Share what they know openly with the world to force UFO disclosure. This is riskier, but there are ways to mitigate it, such as having multiple insiders coming out at once. Importantly, this choice

exposes forever the reality of the crash recovery programs, the corporations and agencies involved, the identities of those who worked for them, and the answers that were obtained. However, it is riskier when it comes to maintaining security clearances.

But I do believe this is worth it. Thousands of soldiers in recent years have sacrificed their lives for absolutely nothing. A great example is how Afghanistan is now falling apart after countless soldiers sacrificed their emotional welfare, physical health, and even lives fighting in that country.

Exposing the UFO cover up would be a cause a million times as significant as some meaningless war in the desert. If an insider did face severe consequences for exposing the greatest lie ever told, he would at least be able to know that his sacrifice was worth something: unlike soldiers right now in their graves or in military hospitals attempting to learn how to walk again. He or she would have made a truly patriotic sacrifice for the ultimate of causes. A peaceful, non-violent, and ethical revelation of truth isn't treason but equal to Rosa Parks' act of refusing to give up her seat on the bus. We need heroes to emerge that will stand up and state, "the government may not share what they know, the corporations may not share what they know, but I cannot live with myself if I participate in the UFO cover up, so in the name of democracy and the constitution, I will share what I know."

The first choice is the easiest. I can understand why many may take it: people want to protect their careers, their income, their lifestyle, and their families (which they may not be able to provide for if they lost their job). I can also fathom why retired seniors may make this choice. They've worked hard for a lifetime and simply don't want to rock the boat. Yet this issue is so fundamentally important to humanity that I believe there must be a few insiders that

recognize their duty to expose the programs and organizations that have lied to everyone—including elected officials, senior military leadership, and the citizens of the United States and the world—for nearly eighty years. Although a harder decision to make due to the serious risks involved, for a patriot who believes that tiny groups of powerful people in corporations shouldn't make decisions for all humanity, I think the decision that should be made is obvious.

I cannot think of a more fascinating, exciting, yet insanely frustrating adventure than the one Eric W. Davis has been on for the past thirty years or longer. He's fought for truth his entire life: the truth about UFOs, the truth about physics, the truth about the programs managing the cover up. Along the way, he received some answers, and, because the EWD document leaked, we've received a few of them. I'm certain that the patriot and scientist in him battles the concerns of legal consequences, career, and family every day of his life. My impression is that he's the kind of person who would like to do everything for everybody, yet he is restrained by the practicalities of life and the bureaucracy the cover up has created. Regardless as to what future decisions he makes, we all owe him for his efforts and openness so far.

My dream is for him to tell his story, all of it, in whole, as soon as possible. I don't know if this will happen, but it needs to. One brave soul with his level of knowledge going on the record would force UFO disclosure—if the corporations liked it or not. Yet it could also serve as a catalyst, inspiring others to share what they know, creating a domino effect—a chorus of witnesses and insiders destroying the fake reality painted by the government ever since Roswell and revealing a new reality, the actual reality that has always existed. The very act of such individuals putting humanity's interest first and cooperating together, coherently, would be an everlasting reminder of the dawning of a new age.

WILSON MEMO PAGES**EWD NOTES**

10/16/02

Eric Davis Meeting with Adm. Wilson

Rich says to go to EG&G Special Projects building at Grier and Paradise. "Meet at 10 A.M. – don't be late!!"

10:10 (Adm. late)

Arrives with two Navy officers in uniform – he's in suit – now civilian
In uniform: 1 (full) Lt.; 1 Cmdr.; a petty officer drives car.

Greetings with Adm. Wilson

We sit in his car in back of EG&G building. Talk until 11:20 A.M. Others departed for building, to attend meeting inside (at 10:10).

TW: Hello! The minute I saw your (EWD) resume, US Uniformed Services ID copy, AF orders and physics paper Rich gave, I knew who you were. Put two and two together, figured you out! Figured who you were!! (Laughs) You don't want to talk about my career or DIA history!!!

EWD: No! Actually not.

TW: I recalled phone call with Oke Shannon in Fall (Aug.?) '99. Big Oke Shannon fan! Go back years in Navy before Oke left for LANL.

TW: Oke talked 2 hours, wanted to convince to talk to me (EWD) about what he told Will Miller ca. June '97 and April '97. Re: Boston Globe Story – L. Kean. Yep, UFO topic – crashed/retrieved UFO craft/bodies, etc. MJ-12 like UFO organization (or cabal)

EWD: What was said?

TW: Confirmed Greer/Miller/Mitchell gave talk in Pentagon Conference room. Adm. Mike Crawford, Gen. Pat Hughes (Hughes his boss) were present (others too.) Date April '97. (Ed Mitchell said 4/9/97.) After group broke up, Miller/Wilson talked (privately) 2 hours on UFOs, MJ-12, Roswell, crashed UFOs/alien bodies, etc. TW intrigued – knew about intelligence on US mil/intell UFO close encounters – and foreign gov't encounters. Seen records. Told Miller.

TW: Yes, Miller asked the question on MJ-12/UFO cabal – crashed UFO. Confirmed he called Miller ca. late June '97 and told that he/Miller was right – there is such an organization in existence.

EWD: What did you tell?

TW: I found it, where I looked, who I talked to but did not name every one - that's it.

EWD: I show Miller letter (to me, EWD) dated 4/25/02 – please evaluate.

TW: (laughs) Didn't tell Miller EVERYTHING! Miller knows what I did in Pentagon Records Group search but no more. Miller can make good educated guess on who (contractors) has alien hardware. Do not pay Miller – sounds hard up to pay for nice Florida home and private beach privilege – (laughs)!

TW: Miller can give good advice on which defense companies to look at – that's all he knows. [changes subject]

- Oke told all about JA (doesn't trust JA, a liar!)
AP-10 group meetings at BDM.
- References Blum's book. Talked about JA, Blum's book, his (Oke's) role there, who attended, etc.
- Oke briefed me on whole BDM thing – talked about RV program for 10 min. I know something of this RV.
- Oke said I (EWD) was team player, would keep mouth shut, no media connections – obey all restrictions – not in government/no clearances, but pedigree excellent – professional/personal references very excellent.

[paper-clipped letter here]



2190 Overbrook Ave. North
Belleair Bluffs, FL 33770
April 25, 2002

Dr. Eric W. Davis, CEO
Warp Drive Metrics
4849 San Rafael Ave.
Las Vegas, NV 89120

Dear Eric,

I must apologize to you and Hal for not getting back with you sooner. The "fog of war", current business activity, and losing your new e-mail address all contributed to the delay, which I regret.

First, I must ask if you and/or Hal would be interested in meeting Mr. Bob Beckwith in Tallahassee, FL the evening of May 30th. Bob has been invited to meet with the head of the Florida Academy of Sciences and the Director of the High Magnetic Field Laboratory for a roundtable discussion of his (Mr. Beckwith's) Force Model of the Universe, and his planned experiments in LTT (levitation, teleportation, and time travel), among other subjects. I believe that the meeting date is now firm, but that will be determined in a conference call Thursday 25 April.

Next, let me respond to a few of your and Hal's previous questions:

I would be willing to assist you and Hal with your ongoing research into UFO crash retrievals and the entities within the government (or outside of it) that are involved in that business, with the following caveats.

First, there must be absolutely NO mention or association of my name with your work or investigation. I have absolutely nothing to gain from such association at this time, and possibly much to lose.

Second, I would charge you only for the actual time I spend in putting together materials, references, or contact lists for you to pursue. I would expect that time to be minimal, since that initial information would not take long to put together (probably less than 8 hours). My standard rate for such work is \$180 per straight-time hour.

Third, nothing I would provide you would be classified from a national security perspective. Although I have held a Top Secret (TS) clearance with access to Special

Compartmented Information (SCI), and other "special" clearances for "other" programs, I currently do not work in the classified realm, nor do I hold those clearances.

As I discussed with you, only by means of working on a current classified government contract and having the "need to know", and thus requesting my previous clearances be reinstated by DoD, would I again work in the classified realm.

Now, all that said, and pending further discussion with you and Hal on your ultimate objectives for having such information, I could provide the following:

1. Particulars on a "special team" involved (as a secondary mission) with recovering crashed "craft" including, but not limited to, the previously classified F-117 Stealth Fighter. This team or its successors, its parent sponsoring entity, and its two key officers may provide some of the information that you seek.
2. The name and last location of a senior officer who I believe had first-hand knowledge U.S. government alien reproduction vehicles (ARVs) at Area-51 and associated locations.
3. The name and current location of a retired senior (Flag-rank) officer who I believe was directly involved in government interaction with a significant UFO event on the east coast of the U.S., and I believe has; by virtue of his former leadership position, high military rank, and control of significant military forces, direct knowledge of USG involvement in this business.
4. A list of civilian government contractors who, by virtue of their past and current highly classified work, current capabilities, clearances, specialized personnel, and geographic areas of concern, most likely have current involvement in and knowledge of USG work in alien-derived technologies, crashes, landing, and associated events.

If you have interest in any of the above, please let me know.

Finally, I have a request: I am trying to locate a company in Las Vegas, NV which some years ago manufactured a specialized disabling "pepper spray" for the military and law enforcement. The company was called "1Mark, Inc." (2300 W. Sahara Ave. Ste. 500) and I knew its V.P., a Mr. Joe Zucharro. Any help in locating him and/or the company would be appreciated.

Best regards,



Will Miller

TW: Told Oke it's a bad time - time no good to talk to me (EWD) - too busy. Said Oke too difficult to contact anymore - heard he was in and out of hospital - extremely sensitive to stress/heart sick - bad news - tried calling: Linda takes messages but none returned, she doesn't want much on Oke's plate for fear... Didn't say yes or no to request - I would think on it. Three years pass and retiring - left DIA July (2002) - replaced by Adm. Jacoby.

TW: Came to test site special area to wrap up projects (he began in '98) - successor can't be bothered with right now for lack of time and knowledge. Did tour/audit/say goodbye to folks. Trip set up by NNSA (National Nuclear Security Agency) - Rich & Doug - you (EWD) know them - AFIO members - told about how new Las Vegas chapter needed guest speakers for chapter/public venue - raise money/membership, etc. Rich/Doug talked about you (EWD!) - phoned from DC - sent me copies of your NASA papers and other related - wormholes your thing. Sent PACAF orders, US ID, Lockheed slides, some reports I wrote for NASA.

EWD: When?

TW: Oh, Sept., after Labor Day. Rich/Doug told me I should talk to you about DIA careers, discuss history, mission, my career in that, etc. I knew better later when I saw your papers and stats they provided - remembered Oke phone call and what he sent me/what he said about you (EWD).

EWD: What did you do with it?

TW: Had office do background checks. Doug/Rich offered to but wanted my own data to be sure. AFIO vouched - AFIO people/DC people now in Vegas vouched.

TW: Gave deep serious thought - recalled Oke's call in '99. Oke really supported me (EWD) - had good arguments.

EWD: What were they?

TW: I (EWD) wouldn't talk to press, to groups (UFO or other such), no media connections, not talk to Miller or Greer or related folks - no vested interest in publicity/money/fame/notoriety, etc.

EWD: We spent time discussing my background - answered his questions on my AF, NASA and related work/interests, etc. History with AF jobs - what I did. Education/career choice, etc. No mention of NIDS!! Oke mentioned JA, me, NIDS in '99, but that's all that was said

TW: Very furious - very angry about Miller (facial expression tense, angry voice)

- Violated personal and professional trust - especially among intelligence colleagues/Navy officers
- There's Navy camaraderie among officers - brotherhood

- Violated that and confidentiality

EWD: How?

TW: Miller told Greer their conversation

- Who knows whom else he and Greer told.

(EWD note – Miller told Ed Mitchell who only told me in 1999)

TW: Then he talks to Kean and Boston Globe articles came out

- Not sure what he told Kean, but articles referenced me (TW)
- FURIOUS!
- Got calls from all over

EWD: What was their nature?

TW: Sarcastic, stupid jokes, stupid comments, comments of surprise and derision (that I would be talking to UFO nuts/nutty UFO groups, etc.)

EW: Who?

TW: Co-workers (flag officers) in Pentagon, lower staff, civilian SES people, people in intell community I work with. Got calls about articles and didn't like it.

TW: I'm taking risk talking to you

- But trusts Oke's word and it is good with me.
- We should have met Oke together face-to-face but present health problems prevent that – too bad!
- So I'll take risk with you

TW: Rich & Doug vouch for you – say your word is good with them. AFIO connection important for trust – you (EWD) know how to be team player

- Background check clear – no derogatory items found
- Korean record good and AF trusts you
- I'm running out of time, so let's go with this!
- If you blow my trust I'll deny meeting you, deny everything said, won't meet with any more people (without clearances) to talk about this topic – too risky because of security violation just by mentioning it – very tightly held info – absurdly closely held subject matter – never seen anything like this program in black programs community

EWD: Okay then, what happened in April – June '97?

TW: After parting with Miller (week later, he thinks) – I made calls, knocked on a few doors, talked to people – went on for 45 days (thereabouts) on and off

- Suggestion came from Ward (Gen. M. Ward) to go through the records groups files (like an index system) in OUSDAT (Office of the Under Secretary of Defense for Acquisition and Technology)
- Ran into Bill Perry in May '97 – talked about this quietly – he suggested the same thing
- They told me of a special projects record group not belonging to usual SAP – a special subset of the unacknowledged/carve-outs/waived programs – not belonging to usual SAP divisions as organized in '94 by Perry himself – set apart from rest but buried/covered by conventional SAPs

EWD: Who was USDAT?

TW: Uh, was Paul Kaminski – talked to both Paul and Mike Kostelnik (a Brig. General)

EWD: Michael Kostelnik?

TW: In Paul's office (OUSDAT) – dir. of special programs in OUSDAT (Office of the Under Secretary of Defense for Acquisition, Technology, and Logistics) as organized (re-organized) by Perry in '94

- Mike is also director of SAPCO (Special Access Programs Coordination Office)
- Mike is member and executive secretary to SAPOC (Special Access Programs Oversight Committee) in capacity as SAPCO director
- Mike is a member of the Senior Review Group

(TW was Deputy Director DIA/Assistant Joint Chief of Staff J-2 at time; boss was Director DIA Gen. Patrick Hughes)

TW: So found the unusual record group – read the index abstracts.

EWD: Budget info?

TW: No budget info – that is kept in separate records for audit purposes.

- A security budget record is copied into a folder for “the program”
- Talked to Mike who said it was like 2-3 times the program budget, but there were times when it went as high as 6-7 times core budget, thought it was absurdly high, said Perry wanted investigation on that but was told to drop it.

EWD: Who told him that?

TW: He didn't want to answer my question on that – said I could find out something from Judy Daly¹.

¹ Judith Daly: Assistant Deputy Under Secretary of Defense for Advanced Development, OUSDAT

TW: She said by phone call that security and other program budget records were being re-vamped and relocated to their own records groups. Security budgets were sometimes cumulative and not annual numbers, easy to see how misunderstanding occurs when comparing to annual program budget figures. 6-7 times could be 2-5 years cumulative total – there have been errors in way security budgets reported.

TW: Perry ordered all these issues to be reorganized and straightened out to improve audit transparency.

EWD: Change subject: so what SAP compartment did you find in?

TW: Core secret – won't say

EWD: Code name?

TW: Again won't say – core secret

EWD: Who was the project contractor or USG agency that runs program?

TW: An aerospace technology contractor – one of the top ones in US

EWD: Who?

TW: Core secret – can't tell

EWD: Defense contractor?

TW: Yes, the best one of them.

EWD: Intelligence too?

TW: In their corporate portfolio

EWD: Give a hint?

TW: Sorry, no.

EWD: What happened when you found contractor?

TW: I made several calls (end of May '97), first to Paul, Mike & Perry to confirm I had right contractor and program manager to talk to.

EWD: They confirm?

TW: Yes.

EWD: Then?

TW: (End of May '97) Made three calls to the program manager – one of them conference call with security director and corporate attorney.

- Confusion on their part as to why I was looking for them and what I wanted from them or wanted to know about.
- Very testy tone from all of them.

EWD: What do you mean?

TW: They were agitated about my calling – surprised by call

EWD: What you asked them?

TW: Yes.

EWD: What was that – what words?

TW: I told I read their program record in the OUSDAT special program records group and wanted to know about their crashed UFO program, what their role in that was, what they had, etc. Also asked if they heard of MJ-12 or some such organization code relating to crashed/recovered UFO craft.

EWD: Reaction on phone to that?

TW: Yes! Asked who I talked to before I called them so I told them and they weren't happy with that answer.

EWD: You mean about Perry, Paul, etc.?

TW: Oh, no! I didn't tell them I talked to those guys!

EWD: Whom else you talked to?

TW: There were the other program managers I called.

EWD: You didn't mention that before!

TW: Thought I said something.

EWD: Who were they?

TW: 3 programs who said they weren't what/who I was looking for. 4 programs that referred me back to the present threesome.

EWD: Why the latter?

TW: Because they were part of it – in different compartments, placed in different layers of the compartments pyramid, split up to do different things or parts of it. They're all in same records group, but their connection to each other is not obvious (typical thing but unusual in records).

EWD: What then?

TW: I told threesome I wanted formal briefing, tour, etc. – was exploiting my regulatory authority as Deputy Director DIA/Assistant Joint Chief of Staff J-2 – Told them my not being briefed was oversight they needed to correct – I demanded!

TW: They needed to discuss this (his demand) so hung up. Got called 2 days later and they said they don't want to talk on phone and arranged for face-to-face meeting at their facility.

EWD: Did you go?

TW: Yes, ten days later (mid-June or so). Flew out there

- Met in their conference room in their secure vault
- Three of them show up

EWD: 3 guys with whom you had telecon?

TW: Yes, same 3

- Security director (NSA-retired, a CI expert)
- Program director
- Corporate attorney
- Called themselves "the watch committee," or gate keepers

EWD: Why that phrase or name?

TW: I asked; they said they were formed out of necessity to protect themselves after a near disaster in the past almost blew their cover – something to do with an agreement that was reached with a couple of Pentagon SESs overseeing SAPs in those days – were vague about when that was.

EWD: What was this?

TW: Let me finish!

- They said years ago in past an audit investigation led to them, and it wasn't supposed to – nearly outed!
- A battle, a nasty back 'n forth between them and the investigator and his Pentagon chief ensued – like a tug of war for program transparency, they told me – money was the issue – their hiding out became the other issue.

- Some kind of threat was leveled to blow the lid off them so they backed down and let the investigator in to complete his job
- (They work very hard to keep program hidden)

EWD: What happened with that?

TW: He was officially briefed, given tour, shown their program

EWD: Did they show him a craft? Or hardware they said was "alien" or from a UFO?

TW: Didn't say more about that.

- Said after that episode a formal agreement was struck with Pentagon people (SAPOC) to prevent this in future – didn't want a repeat
- Special criteria were established in agreement
 - o A special circumstance that must meet rigorous access criteria set by contractor committee
- No USG personnel are to gain access unless they met the criteria – to be administered by contractor committee (program director, attorney, security director) irregardless of the tickets and position USG personnel possessed
- Literally their way or the highway

EWD: What are criteria?

TW: I asked for that and they refused to give answer. I was mad – implication is now – to me – they operate without official oversight or any justification – politically dangerous place to be!

- [Threesome concerned with who TW had talked to at Pentagon or elsewhere – by phone/FAX/email – wanted accounting of conversations – concerned about new exposure]
- Purpose of meeting was to tell me this.

EWD: What?

TW: That they weren't going to let me in the door

EWD: Why?

TW: They said my tickets were all confirmed and valid, but I was not on the bigot list

- My tickets alone were not enough
- I didn't meet the special criteria so need to know authorization was not being granted
- Went back 'n forth with them over these points (primarily with security director & attorney)

TW: Argued more – they wouldn't accept my arguments that they fell under my statutory oversight and regulatory authority as Deputy Director DIA – under purview for my right to have need to know (oversight, audit, justification issues, etc., etc.)

- Regulatory and statutory authority as Deputy Director DIA not relevant or pertinent to nature of their program!
- Then they pulled out their bigot list to convince me otherwise – several pages long – dated 1990, updated 1993.

EWD: Who was on it? Recognize names?

TW: That is core secret.

- Willing to say that most were program employees – names and titles (job titles) – civilians – didn't recognize any military personnel – could be there.

EWD: Any politicians?

TW: No

- No White House names, no President!
- No Congressional people
- No Congressional staffers

EWD: Any in Clinton or Bush Sr. Administrations?

TW: No! But handful of names were Pentagon individuals I recognized – few from OUSDAT, one from another department, another at the NSC who is Pentagon SES employee.

- Program Manager said they were
 - o Not any weapons program
 - o Not any intelligence program
 - o Not any special ops or logistics program
 - o Doesn't fit these categories
- I asked what they were then
- Loud groan from Program Manager
- Security Director and attorney say it's okay to say it.

EWD: Say what?

TW: They were a reverse engineering program –

- Something recovered years ago in the past
- Technological hardware was recovered
- So I thought they meant recovered Soviet/Chinese, etc. hardware and reverse engineer it - like a missile or intell platform or aircraft - actually came to meeting expecting to find a sensitive foreign collection and reverse engineering operation - thought "UFOs" used as a cover for that -
- So I said that and they said they weren't that either

- They had (program manager talking) a craft – an intact craft they believed could fly (space? air? water? dimensions?)
- Was it from overseas or not?
- Said NO! Could not be – not possible!!
- Why, I asked – where did it come from?
- Program manager said they didn't know where it was from [they had some ideas on this] – it was technology that *was not of this Earth – not made by man – not by human hands*
- Said were trying to understand and exploit technology; their program was going on for years and years with very slow progress
- Agonizingly slow with little or no success – painful lack of collaboration to get help from outside community of experts and facilities to assist effort – must remain isolated and use own facilities and cleared personnel – tough environment to work – about 400-800 (bigot list count) workers varying in number with funding or personnel changes
- Miller questions asked:
 - o Roswell – craft/bodies/autopsies
 - o Holloman AFB Landing
 - o MJ-12 and leaked docs
 - o Zamora & Bentwaters, etc.
- They were mum – declined to discuss these
- TW threatened to go to SAPOC to complain, gain access to their program
- They said go ahead and do what you must
- I was angry because they defied my authority to be read-in with good logical reason – wouldn't budge
- Their tone was very testy/terse throughout conversation

EWD: What was outcome?

TW: Meeting broke up and I returned to Washington

EWD: What about Corso?

TW: Greer talked about Corso on April 9th

- Miller showed me the book during two-hour private conversation
- Didn't have time to read it through
- Didn't buy a copy
- Didn't bring Corso up at meeting
- But comparing Corso story to what I learned at meeting is more than enough to believe Corso told truth about seeing "alien" hardware, etc.

EWD: Did you complain to SAPOC?

TW: Yes – called the subgroup members (Senior Review Group members) to a meeting at Pentagon

- Told them what happened at meeting

- They responded that they would sustain the contractor on their access denial
- So I ended up arguing with them a while
- Broke up in 20 minutes and they would meet me in 2-3 days
- Got the call 2 days later (near end of June) and met again with Senior Review Group members

EWD: When?

TW: Before last week of June ('97)

- They told me (TW) that they were sustaining the contractor, that I was to immediately drop the matter and let it go – forget about it as I did not have purview over their project, it didn't fall within my oversight, etc.
- I became very angry – started yelling when should have kept my mouth shut

EWD: Miller and Greer said you nearly got busted.

TW: Close to that!

- Told Miller Senior Review Group chairman said if I didn't follow their suggestion that I would not see Director DIA promotion, get early retirement, lose 1 or 2 stars along the way
- Really incredibly angry – upset over this – livid!!!
- Why such a big deal over this considering the position of trust I have in the Pentagon – I do have relevant regulatory/statutory authority over their program – that's my position!!!

EWD: Is it because funding comes from you or through you? Or Director DIA?

TW: Core secret – can't answer

EWD: Back to bigot list – can you describe type of people?

TW: Corporate types – scientists and technicians– engineers, scientists, managers, etc.

EWD: Any military organizations you recognized?

TW: None – just OUSDAT people – and two on SAPOC – one other Pentagon office

- In Dec. '97 Paul was out as USDAT, left gov't – so was Mike K., replaced too

EWD: By whom?

TW: Jacques Gansler was new USDAT, started Dec. '97

- Mike K. was replaced by Brig. Gen. M. Ward (AF)

EWD: Were Paul K. and Mike K. and Jacques Gansler and Gen. Ward the ones on the bigot list you recognized?

TW: Won't answer that.

TW: Talked to Gansler in Jan '98 about my June '97 meetings.

- He was briefed by someone! Surprised me

EWD: What did he say?

TW: "UFOs are real, so-called 'alien abductions' not real" - Gansler said this

EWD: What else?

TW: Told to drop the matter – no more discussion about it.

EWD: Willing to talk to Hal Puthoff and Kit Green? (Discussed who they are, and RV program history)

- TW not familiar with names, heard about RV program in 1990
- Maybe/maybe not for Hal – would think about it.
- No response on Kit Green.
- Prefers never to talk to anyone else about this again – risks exposure – better to stop talking, cut it off here.

TW: What will you (EWD) do with this?

EWD: Keep for private/personal research – data collection to track down the story and ascertain signal/noise in media and from gov't sources. Will keep mouth shut, etc. etc. Told Wilson about Mary Elizabeth Elliot-TRW story, Ingo's story and 1974 RVer woman who went to WPAFB – trying to make connection.

TW: Feedback – Mary Elliot sounds like real deal based on her info and behavior with attorney (Jeffrey W. Griffith)

- Probably will only come totally clean on her deathbed 30 years from now.
- Don't know about Ingo, Axelrod, or RVer woman at WPAFB – doesn't have info on their stories from sources.
- Asks for Corso material (will send)

EWD: NOTE - TW asks for briefing book on my work (NASA/AFRL) – send other papers if I want to.

- Given office address in D.C. to mail
- Will retire to Midwest and close office in 2003.

This page has no content.

The Secret Space Program

This part of the paper consists of five parts.

- 1. Timothy Good and his knowledge of "The Secret Space Program."*
- 2. Gary McKinnon and his contact with "The Secret Space Program."*
- 3. The Nimitz engagement: Commander David Fravor and his possible contact with "The Secret Space Program."*
- 4. Flying saucers and Tic-Tacs were at the Nimitz engagement.*
- 5. Solar Warden and the authors information about the "The Secret Space Program."*
- 6. The United States Patent for the TR-3B, that is being used for "The Secret Space Program."*

1. TIMOTHY GOOD

Gaia

Open Minds

Host: Regina Meredith

Interview with Timothy Good during the International UFO Congress (2014, Scottsdale, Arizona). Timothy Good has spent the majority of his life having access to some of the most secret archives in the field.

[See gaia.com.]



Timothy Good



Paul LaViolette

Regina Meredith: I was so intrigued with some of the stories and images. And I took down pages and pages of notes, however, we're going to focus maybe a little more in depth on only six or seven of the topics. And one of them that I found interesting that I have not heard people speak about is the notion that it's not just reverse engineered craft that have happened around the world. But you say the truth is since the 70s we've been experimenting with, and actually flying, alien craft directly.

Timothy Good: I think earlier than that, actually.

Regina Meredith: Talk about this phenomenon.

Timothy Good: My information comes from several sources. One is a former army intelligence officer, whom I've known for many years, and he's a very trusty aerospace journalist. He indicated to me that from the mid 50s, we were developing alien technology, and we had mastered alien technology in a relative short time. That was quite surprising, apparently. And we have been given actual craft by certain aliens who have our best interests at heart. We have been given the technology and the craft and we have been flying them for a very long time. And that is

my information. Even Gordon Cooper the astronaut, whom I knew, we corresponded...I think we spoke on the phone. But according to a friend of his, who I know and trust implicitly...Well. It's known that Gordon Cooper became with the way the United Nations ignored the subject back in 1978. There was a meeting, I think in Florida...a Florida branch of the United Nations...and he was very, very unhappy about it. And he said, what does it take? Do I have to fly one of these craft and land it outside the United Nations building in New York? He was actually prepared to do that.

Regina Meredith: He wasn't joking?

Timothy Good: No. I thought it was a joke until this friend of mine said, no, he was being absolutely serious because quite a number of the astronauts had been flying these craft. There is a real space program.

Regina Meredith: Yes!

Timothy Good: And there is a cover space program, which is the NASA space program.

Regina Meredith: Exactly.

Timothy Good: My information is for example the United States Air Force Space Command is actually in charge of the proper space program. And this information comes via Paul LaViolette, who is an excellent writer.

[Paul LaViolette is a pioneer in electro-gravitics and frontier science. He is 74 years old.]

Regina Meredith: I know Paul LaViolette.

Timothy Good: He's a physicist, and he gets hold of some very good information. And we get on well. I've only met him once, but he's a very bright lad.

Regina Meredith: Yes, he is. He's a good researcher.

Timothy Good: He said he was told that the U.S. Air Force Space Command had a base in the Pacific Ocean somewhere. They've got a huge shuttle fleet that goes regularly to the moon, and to Mars. Apparently. And I don't disbelieve him.

Regina Meredith: Well, and it...I believe it was Neil Armstrong that said there were other spacecraft and things on the moon.

Timothy Good: That was actually picked up and recorded.

Regina Meredith: Yes, it was!

Timothy Good: It's a matter of fact. I had a friend named Pamela Hanford who was in MI6. I knew her for many years. She's passed away now, which is why she allowed me to use her name for the first time. The story actually came out in my first book, *Above Top Secret*. But I couldn't mention her name because of her background. But in any event she participated in an event—a restricted NASA conference in 1984 in Anacapri, Italy. Her bedroom adjoined that of Neil Armstrong, and the bedroom beyond that was Buzz Aldrin's. She said she overheard . . . I'm quite sure she bugged their rooms.

Regina Meredith: Well if she was MI6, likely she had the technology.

Timothy Good: As they do. And she overheard this conversation with a German professor—a Professor Schwartz—saying, tell us, come on, come on, tell us what really happened on the moon. And he [Neil Armstrong] said, “Oh, it was dreadful. We got there, and there were these spaceships, and they were menacing.” Pamela got all this, and so at cocktails later on that day or the next, I forget which, she accosted Armstrong and said, “Oh, by the way, can you tell me more about what went on, on the moon?” And he told her, “We were very frightened. It was very disturbing. There were two large menacing spaceships.” So that's the cover space program which is NASA.

Pamela also told me that the United States has been in regular communication with a planet. She didn't reveal to me which planet—she just said a planet. We've got highly advanced craft that are being flown by our guys. (See the President Reagan briefing for more information.)

[CAM: Now knowing that there are aliens, what do you think the likelihood of the above is true?]

2. GARY MCKINNON

Richard Dolan Show

Host: Richard Dolan

UK citizen Gary McKinnon is the most famous UFO “hacker” of all time. Arrested in 2002, he was in danger of extradition to the US for ten years. What he found was apparent evidence of a secret space program, including references to “non-terrestrial officers” and ship to ship transfers of vessels not in the U.S. military inventory. Moreover, a high-resolution photograph, taken from space, of a smooth, cigar-shaped craft. This is his first interview in many years. [See “Perfectly Smooth Shell of a Craft,” 2019, youtube.com/watch?v=y6Is7809XFU]



Gary McKinnon



Donna Hare

Richard Dolan: The Pentagon stated that you perpetrated the biggest military computer hack of all time and cost them all this ridiculous amount of money. . . . You were looking for unguarded sites within the Pentagon, isn't that so? . . . You found fleet to fleet transfers and a few other things, nonterrestrial officers and so . . . What did you find?

Gary McKinnon: I found an Excel spreadsheet and there was a nonterrestrial officers list and I can't remember the file name but heading on the column was nonterrestrial officers and I looked it up at the time and it was nowhere, absolutely nowhere in that exact phrase, you know you put in the quotation marks and do a Google search. I took it to be evidence of an OFF EARTH FLEET! To have nonterrestrial officers you must have spaceships to base, maybe in geo-stationary orbit.

. . . I was at the NASA Johnson Space center due to the testimony of Donna Hare, of the Disclosure project.

Richard Dolan: Donna Hare worked for Philco Ford, which was a NASA subcontractor in the early 70s, and she has had a lot to say about what she learned through her NASA colleagues about a secret space program, and she's made some very very forth-right statements about NASA's engagement with UFOs and astronauts encountering UFOs on their missions and so forth so you're referring to her.

Gary McKinnon: Yes, She had a secret clearance in the area where she worked, bearing in mind that some of these setups, there are lots of open areas near each other but they all have different clearances, you don't necessarily have locked doors apparently and she's at work one day and she wanders she wanders into another area with a colleague and to another colleague has got an Air brush machine, an electronic airbrushing kit, basically. For the high-resolution satellite imaging and he says Donna look at this, tell me what you think? And he shows her like a white disc above the terrain and the shadow of this white disc on the terrain. She didn't notice the shadow at first and she say's well, being a photographic launch mission specialist she worked with photographic slides and stuff, She didn't notice the shadow at first and said it could be a blob in the emulsion or something. He said, "Yea, but look at the shadow." It was quite clear and you could see after that the disc shaped craft, the shadow was shaped out of the rocks the trees in the terrain. In the retelling of this, she mentions which space center it was at, Johnson, and which building it was in, which was building 8.

CAM: Later Gary McKinnon went back in to have a look for himself. He got into a file and what he started to download showed the Earth and a UFO space ship in the shape of a cylinder with geodesic domes attached to the ends as well as the top and bottom center. Before he could save the image, he saw the mouse move, and he was disconnected.

The proof that what Gary McKinnon is saying is true is that the US government came after him and tried for 10 years to get him. His hard drive is sitting

in a drawer in the office of Naval intelligence in the U.S.

Let's talk about the likelihood or unlikelihood of Gary McKinnon telling the truth of what he found when he invaded these Navy computers. He found an Excel spreadsheet that showed a nonterrestrial officers list, as well as ship to ship transfers. So I ask myself why these things and not something more compelling? The answer for me here is that he is simply reporting what he saw. To my knowledge he has never embellished on what he found, and for me that is to his credit.

Later he got into a file, and what he started to download showed the Earth and a space ship in the shape of a cylinder with geodesic domes attached to the ends as well as the top and bottom center. I personally find this design interesting because as far as I know his description is unique. This unique design would put this ship in the "ours" category. Why didn't he describe a saucer or a Tic-Tac or the cigar-shaped craft that are so often reported? Again, he reported what he saw, so I am giving him the benefit of the doubt. Remember our government spent 10 years trying to get him. Why, if they weren't so worried about what he had found.

The following is from Wikipedia.

Gary McKinnon (born 10 February 1966) is a Scottish^[1] systems administrator and hacker who was accused in 2002 of perpetrating the "biggest military computer hack of all time,"^[2] although McKinnon himself states that he was merely looking for evidence of free energy suppression and a cover-up of UFO activity and other technologies potentially useful to the public. On 16 October 2012, after a series of legal proceedings in Britain, then Home Secretary Theresa May blocked extradition to the United States. . . .

McKinnon has admitted in many public statements that he obtained unauthorised access to computer systems in the United States including those mentioned in the United States indictment. He states his motivation, drawn from a statement made before the Washington Press Club on 9 May 2001 by the Disclosure Project, was to find evidence of UFOs, antigravity technology, and the suppression of "free energy", all of which he states to have proven through his actions.^{[36][37]}

In an interview televised on the BBC's Click program,^[38] he stated of the Disclosure Project that "they are some very credible, relied-upon people, all saying yes, there is UFO technology, there's anti-gravity, there's free energy, and it's extraterrestrial in origin and [they've] captured spacecraft and reverse engineered it." He said he investigated a NASA photographic expert's claim that at the Johnson Space Center's Building 8, images were regularly cleaned of evidence of UFO craft, and confirmed this, comparing the raw originals with the "processed" images. He stated to have viewed a detailed image of "something not man-made" and "cigar shaped" floating above the northern hemisphere, and assuming his viewing would be undisrupted owing to the hour, he did not think of capturing the image because he was "bedazzled", and therefore did not think of securing it with the screen capture function in the software at the point when his connection was interrupted.^[39]

[See full content and footnotes at en.wikipedia.org/wiki/Gary_McKinnon.]

CAM: Now knowing that there are aliens, what do you think the likelihood of the above is true?



Opens with the pyramid video.



Commander David Fravor

3. THE NIMITZ ENGAGEMENT

60 Minutes Overtime

Interview by Bill Whitaker

"Navy pilots recall 'unsettling' 2004 UAP sighting"
[\[youtube.com/watch?v=ygB4EZ7ggig\]](https://www.youtube.com/watch?v=ygB4EZ7ggig)

In November 2004 Cmdr. David Fravor and Lt. Cmdr. Alex Dietrich were training with the USS Nimitz Carrier Strike Group 100 miles southwest of San Diego. Radar picked up a target descending 80,000 feet in less than a second. They were ordered to investigate and found an area of white water in an otherwise calm blue sea. It appeared to them that an object the size of a 737 was just under the water.

Commander Fravor: So as we're looking at this, her back seater says, "Hey, skipper, do you?" And about that got out, I said, "Dude, do you see that thing down there?" And we saw this little white Tic-Tac looking object. And it's just kind of moving above the white water.

Lt. Commander Dietrich: Do you ever drop your phone, and it bounces off the countertop and bounces off something else? [She makes zig-zagging motions with her hands.] No predictable movement, no predictable trajectory. No acceleration.

Commander Fravor: It was just like a ping pong ball—very, very random.

Bill Whitaker "As Dietrich circled above, Fravor went in for a closer look. So you're sort of spiraling down?"

Commander Fravor: The Tic-Tac's still pointing north-south it goes, "burp" and just turns abruptly

and starts mirroring me, so as I'm coming down it starts coming up.

Bill Whitaker: So It's mimicking your moves

Commander Fravor: Yeah it's aware we were there! I wanted to see how close I can get, so I go like this (makes a flying motion with his hands) and it's climbing still and when it gets right in front of me it just disappears. Disappears, like gone and

Bill Whitaker: And you saw no visible propulsion, no wing or anything to make it fly in our atmosphere.

Commander Fravor: When it turned and started coming up, it was like OK! We have nothing that goes that fast and that just starts climbing at will

Bill Whitaker: Seconds later the Princeton reacquired that target 60 miles away.

Commander Fravor: It just appeared there!

CAM: I married the above with what is below because it has additional details that I want to include.

Lex Fridman Podcast #122

“David Fravor: UFOs, Aliens, fighter Jets, and Aerospace Engineering”

[youtube.com/watch?v=aB8zcAttP1E&t]

David Fravor: It's gone we don't know where it's at, so we spin around, and the white water's gone.

CAM: At 1 hour 28 minutes David Fravor talks about how the UAP is now at the CAP (combat air patrol) point. CAP points are secret points in space where the military rendezvous to start their exercises.

David Fravor: As we're flying back the controller, the kid on the Princeton, they're called OSs=Operation Specialists—they're the ones that run the radars, and we're talking to him and he's like, “Sir, you're not going to believe this, but that thing is at your CAP.” It showed back up. It just popped up, this is like sixty miles away. It just reappears, so we got the radars out there looking for it. We get out there; we never see it again.

CAM: How the heck did it know where the CAP point was? I propose two options here. (1) It has extremely sophisticated systems that can scan all our systems. (2) It's ours. Using Occam's razor is a principle of theory construction or evaluation where, other things equal, explanations that posit fewer entities or fewer kinds of entities, are to be preferred to explanations that posit more. What this philosophical razor advocates is that when presented with competing hypotheses about the same prediction, one should select the one with the fewest assumptions.

4. FLYING SAUCERS AND TIC TACS WERE AT THE NIMITZ ENGAGEMENT

Lehto Files

Chris Lehto was an F16 pilot for 18 years and retired in 2020. He spends his free time making investigative YouTube videos about unexplained aerial phenomena. In this video Chris Lehto uses Jeremy Corbell's interview with radar operator Trevor to analyze what happened. [youtube.com/watch?v=9Fx6HOrABrs]

During the Nimitz engagement USS Princeton Radar Operator Trevor says he saw a clear video of a flying saucer shooting up out of the water and mimicking the F18 movements. He did not see a Tic-Tac. Listen to the full interview, “2004 Nimitz TIC TAC UFO Event Series / New Witness / Presented by Jeremy Corbell,” from Jeremy Corbell's YouTube channel here: [youtube.com/watch?v=-VWVzawwleU].

Jeremy Corbell: Trevor was an E4 (Petty Officer Third Class) Naval Operations Specialist providing command technical information and assistance related to anti-surface and anti-air warfare. And, as a radar operator, he was direct witness to one of the most current and well-documented UFO encounters in modern history. On December 21, 2017, there was a tectonic shift in secrecy around the subject of UFOs. The Department of Defense authorized two videos of fighter pilots engaging UFOs to be released to the public, and the *New York Times* published a story about our government's involvement in studying the subject. The 2004 *Nimitz* “Tic-Tac” UFO encounters became the tip of the spear in the public debate on UFOs. Commander David Fravor, a fighter pilot with the Black Aces, came forward with

his experiences and testimony. There were a number of individuals during the events who were aware of what was unfolding. Trevor is one of them. More and more witnesses are coming forward to date. . . .

This UFO case was on my radar for years prior, and I took time to build a small network of witnesses involved in this unique, military UFO event series. The story is now out, and the pieces are being put together by the public. And the news continues to explode and be understood around the world. Government footage from active UFO engagements. Trevor's testimony is unique, and, as you will hear, he was exposed to footage from the event series that sounds a bit different than what is now in the public realm. I'm just reporting the news. It's up to you to make sense of it all. [From the interview video description]

Back to Chris Lehto Commentary

Princeton Air Radar Operator Trevor: "You know they can't believe what they're seeing but they can't and it's true"

Jeremy Corbell: So this footage you saw is different than the footage you see that has been released by the department of defense?

Trevor: Oh yes, I've watched it several times, and it's not the same. I definitely saw different footage during those 2004 events. They were of a different object by far. The object I saw was a flying saucer shape not a Tic-Tac!

Chris Lehto: Wait?! Did I hear that right?

Trevor: A flying saucer shape, not a Tic-Tac.

Lehto: Yep. That's what I thought he said! Wow, listen to that. That was from Trevor talking with Jeremy Corbell. Trevor was a petty officer third class. He worked as radar operator on the Princeton, and he says he was there on 14 November 2004, when commander Fravor intercepted the Tic-Tac, he was on the ship and very interesting he says that he saw another object and that object was not a Tic-Tac, was not a Tic-Tac. Listen to this.

Corbell: You don't believe this saucer technology is ours.

Trevor: Definitely not—maybe we are experimenting with stuff like that. Yeah, I mean I've never seen anything like it.

Corbell: It's the common understanding of the people you talked with that this is not human technology.

Trevor: Yeah! No, especially aircraft going in and out of the water.

Corbell: Out of the water?

Trevor: Correct. I was seeing things on the radar. I just remember the one day where it was very obvious that something was going on in the top left side of box (operating box) because we all have our own specific box that we do circles in. I just thought it was suspicious. I mean with all the experience and the things that I've seen.

Corbell: So, we're talking about 2004 on the *Nimitz* [carrier strike group].

Trevor: . . . I was one of the senior people on air radar. I was in charge of scenic or low vis., supply po.

Corbell: You were in charge of an aspect of radar operations on the *Nimitz* [carrier strike group] during that UFO event.

Trevor: Correct, yes I was part of an air watch team.

Corbell: In 2004, between November 10 through November 14, there was a whole series of events. There was a crescendo. Commander David Fravor, and the flight group that went after him, came back with footage of these events and came back on board. But your experience was a little different, you were in a secure radar room and started to notice something strange and you were the first to notice it.

Trevor: Yeah, we were in CDC.

Corbell: What is that?

Trevor: Combat direction center—what they call the quote-unquote heart of the ship.

Corbell: It's a normal day and all of a sudden what happens?

Trevor: You just start seeing things in that top left corner of the box, start seeing things blip in and out.

You just see something, chilling there, for a little bit, and boom it's gone. And then it's over here in a different area of that corner. It's like flashing, It's solid because it's gone, and it moves to the left, or to the right, so it keeps doing that—like it's moving around. You know there's activity going on. Thinking to myself, What the hell's going on? I let my supervisors know what's going on, and they said okay. You know? It was no big deal. You'd mark aircraft—whatever they were, you would mark them. I couldn't do it, because that object or whatever that was blipping in and out—I couldn't track it, so they basically ignored it my whole watch, at least that's what I know. Maybe they knew something. I don't know.

Lehto: So Trevor is basically out there supporting. He is in charge of air radar, so he's basically a radar controller talking to pilots or directing in areas and he sees these contacts that seem very strange to him, and they're moving around. So what he sees is activity, as he mentions.

His contact is moving faster than he can tag. So normally you would go and tag these contacts and say that is a contact, so they can start trying to determine its identification. But he couldn't even do that, because these things are moving too much. When he goes to click on it, it would actually be gone.

He brings it up to his superiors. They say okay, but they don't say anything back to him, so he doesn't know what's going on.

Corbell: And you can't tell if it was multiple objects?

Trevor: Yeah, I couldn't tell you that.

Corbell: How many anomalous targets did you see during that course of the beginning of observing this on your radar?

Trevor: I'm on watch six to eight hours, so it's the whole time I'm on watch.

Corbell: Is this the day that the whole ship became alerted that evening, that pilots came in with footage?

Trevor: The only thing I could tell you is, yes, it is that day. I'll never forget that day the rest of my life. I gave my pass down the end of my watch. I gave my

pass down, and I passed down that activity to one specific person, and that one specific person is the one that called me to come up and look at the video.

Corbell: You were relieved of your command in the afternoon between 11:00 a.m. and 1:00 p.m., but it was that day November 14, 2004, when commander David Fravor came back, and the flight after him, with footage, and that spread like wildfire across the ship that they had caught something—the UFOs. But something else happened, so you are relieved of your command, you go back to your berthing. In being relieved of your command, you pass the information forward to somebody. In an unusual move, you were called to view some footage, because I guess they felt like they owed you that much for being the first to actually see and try to target these things. So can you explain to me, you're in your berthing, what exactly happened?

Trevor: I get a phone call. You know, I didn't think anything of it, so he's like, "Dude, you've got to get up here right now and check this out. He goes you're right! I didn't run, but I hauled ass up to the CDC. I got up there and sure enough they brought me over sat down, watched the video. I watched it with a few officers. A couple that were you know were pilots and you know, a few that weren't. Many of these people have had, you know eons in the navy. So we're just sitting there watching the video, and slow motioning the video, watching it several times.

Corbell: You've already said a couple times that you've tried to dig into this that you've tried to get other people involved in that day to talk to you, that people seen hesitant or resistant to talk about this event. Why is that?

Trevor: Great question, I don't know. I know the one guy, is you know he's a patriot you know. I don't know if he feels like he's going against the government or his country. I don't know.

(Back on the ship) I did talk to a female, lots of activity going on. I don't touch the computer, I don't touch any of that stuff they're sitting there showing me what's going on and it's already downloaded.

Lehto: So Trevor's called in. I believe he's called by Kevin Day or someone that works with him in the

radar, above him in the radar section, uh he goes up to the room, he goes into the CDC says there's a few pilots there, there's some other non-pilots he says all officers is what it sounded like to me and then he watched the actual video. So he watches the video. Let's see what he says here.

Trevor: Cypronet is a secured secret, downloaded already to that net.

Corbell: The video was downloaded to that net?

Trevor: yeah, the one that I saw yeah. When I came in there I didn't know any of that. You know what I mean, I had no clue until a month or so ago, that a pilot actually came in there with footage. So I think the footage that I saw, I'm guessing it's got to be from underneath the nose of the F-18.

Corbell: They quickly uploaded that to cypronet and the footage you saw you describe it very differently than what is out there about the events what. What do you see on the screen?

Trevor: You can see that the F-18s are moving and you see this object mimic the F-18s this object had shot from basically from the ocean up. You could see that, that object made a couple different quick maneuvers, so if the F-18 made a left bank it mocked the F-18, every time.

Lehto: Wow, listen to that. So Trevor says he's sitting there in the CDC, he watches this video, he sees the object comes out of the ocean, comes out of the water, so there's video of that right, that would be pretty nice to see, and then he sees that it's moving back and forth in relation to the F-18s, so there's some sort of motion there, but, very interesting to me.

Corbell: Describing the object mirroring the pilot so, actually mirroring the movements, like mocking the movements.

Trevor: Yea

Corbell: It was outpacing our best fighter planes.

Trevor: Oh easy! Oh my God, yeah. The last part of the video that I remember is that this object, if your looking at the screen it went left and then it banked straight up, I mean It was just insane! I couldn't even

explain, like it just went to the left really fast, BOOM! Went straight up! And I know this was on cypronet because we slowed it down, like they slowed it down, frame by frame, basically in slow-mo, and you could see where this thing, it doesn't even exist, like it, like it SKIPS time! You know where it's that fast, you cannot see this object for a period of a couple frames. Then it just goes BOOM, it goes up, and I remember the officers saying there's nothing on this planet that can do that, it's not possible. That aircraft should be in pieces. How may Gs is that? To pull up like that! It's just not possible.

Lehto: It's a lot of Gs I'll show you here in a second how many Gs that could be, but that was an amazing interview from Jeremy Corbell, thank you, Jeremy, for getting this done and for Trevor for speaking as the radar operator.

Interesting for me is that it looked just like a normal flying saucer coming out of the ocean.

For the actual Gs we can go to this paper by Kevin Knuth, Robert Powell, and Peter Reali. This is back in 2019 and this is a peer-reviewed paper about UAPs and the *Nimitz* engagement and another engagement—so great work from Kevin Knuth. If you look at the very end of this paper, you see funding. This research received no external funding, so these guys funded it on their own time, so thank you, gentlemen.

So, if we go to the *Nimitz* encounters here, this section 2.4. On 14 November 2004 the U.S. Navy's carrier strike group 11, which includes the USS *Nimitz* nuclear aircraft carrier and the Ticonderoga-class guided missile cruiser USS *Princeton* was conducting training off the coast of southern California when the *Princeton's* radar systems detected as many as 20 anomalous aerial vehicles which could not be identified.

Those were the contacts that Trevor was talking about—couldn't be identified, he couldn't lock them, or actually tag them to start any sort of identification. UAVs entering the training area were deemed a safety hazard to the upcoming exercise. Yeah, it sounds like they were there for a while and notification was brought up to these guys. And that is when the captain of the USS *Princeton* ordered an interception by the two F-18 Super Hornet jets. That's

when we get the David Fravor intercept that you can reference in my past videos. I have multiple videos on that specific engagement.

In this video, it's interesting to me that senior chief of operations, Kevin Day, had an important role. He's a top gun graduate. He had an important role as leading the USS *Princeton*. The USS *Princeton* is in charge of doing air defense protection for the strike group, so that's why they're integrating with the fighters.

The *Princeton* was equipped with the spy-1 radar system which provided situational awareness of the surrounding air space. This spy-1 is a brand new system that they installed—cutting edge—and it has ASA technology (active electronically scanned array technology). The main incident that we're talking about occurred on November 14, 2004. But several days earlier radar operators on the USS *Princeton* were detecting UAPs appearing on radar at about 80,000 plus feet altitude for the north of the group in the vicinity of Santa Catalina and San Clemente islands.

Think of that, so they're picking these up on radar above 80,000 feet. That's very, very high. Also senior chief Kevin Day informed us that the ballistic missile defense radar systems had detected the UAPs

in low Earth orbit BEFORE they dropped down to 80,000 feet. So think they also have contacts from the ballistic missile defense coming into 80,000 feet. The objects would arrive in groups of 10 to 20 and subsequently drop down to 28,000 feet with several hundred foot variation and track south at a speed of about 100 knots. So they were tracked from space by the ballistic missile defense system, then they were tracked from 80,000 feet by the spy-1 radar and down to 28,000 feet where they would just hold altitude and cruise south at a 100 knots (which is very slow up at 28,000 feet). There's very little air. Helicopters can't fly up there. Drones are going to have very big problems flying up there. So that is very strange. Periodically the UAPs would drop down from 28,000 feet to sea level, estimated to be 50 feet or under the surface, in .78 seconds. That's amazingly fast. That's what Trevor's talking about. How many Gs does that actually take? If we scroll down here, it's a lot, upwards of 5,000 Gs.

5,000 Gs is basically the center of this probability curve, and the low end is 3,000 Gs which is unbelievable—an unbelievable number. Normal G forces are 9 Gs for any plane that they could possibly take! Humans can only take 9 Gs. Planes rip apart at 15 Gs.

2.4.1. Senior Chief Operations Specialist Kevin Day (RADAR)

An important role of the USS *Princeton* is to act as air defense protection for the strike group. The *Princeton* was equipped with the SPY-1 radar system which provided situational awareness of the surrounding airspace. The main incident occurred on 14 November 2004, but several days earlier, radar operators on the USS *Princeton* were detecting UAPs appearing on radar at about 80,000+ feet altitude to the north of CSG11 in the vicinity of Santa Catalina and San Clemente Islands. Senior Chief Kevin Day informed us that the Ballistic Missile Defense (BMD) radar systems had detected the UAPs in low Earth orbit before they dropped down to 80,000 feet [23]. The objects would arrive in groups of 10 to 20 and subsequently drop down to 28,000 feet with a several hundred foot variation, and track south at a speed of about 100 knots [23]. Periodically, the UAPs would drop from 28,000 feet to sea level (estimated to be 50 feet), or under the surface, in 0.78 s. Without detailed radar data, it is not possible to know the acceleration of the UAPs as a function of time as they descended to the sea surface. However, one can estimate a lower bound on the acceleration, by assuming that the UAPs accelerated at a constant rate halfway and then decelerated at the same rate for the remaining distance as in (2) and (3).



Article

Estimating Flight Characteristics of Anomalous Unidentified Aerial Vehicles

Kevin H. Knuth ^{1,2,*} , Robert M. Powell ²  and Peter A. Reali ²

¹ Department of Physics, University at Albany (SUNY), Albany, NY 12222, USA

² Scientific Coalition for UAP Studies (SCU), Fort Myers, FL 33913, USA;
robertmaxpowell@gmail.com (R.M.P.); preali@cableone.net (P.A.R.)

* Correspondence: kknuth@albany.edu

Received: 21 August 2019; Accepted: 21 September 2019; Published: 25 September 2019



Abstract: Several Unidentified Aerial Phenomena (UAP) encountered by military, commercial, and civilian aircraft have been reported to be structured craft that exhibit ‘impossible’ flight characteristics. We consider a handful of well-documented encounters, including the 2004 encounters with the *Nimitz* Carrier Group off the coast of California, and estimate lower bounds on the accelerations exhibited by the craft during the observed maneuvers. Estimated accelerations range from almost 100 g to 1000s of gs with no observed air disturbance, no sonic booms, and no evidence of excessive heat commensurate with even the minimal estimated energies. In accordance with observations, the estimated parameters describing the behavior of these craft are both anomalous and surprising. The extreme estimated flight characteristics reveal that these observations are either fabricated or seriously in error, or that these craft exhibit technology far more advanced than any known craft on Earth. In many cases, the number and quality of witnesses, the variety of roles they played in the encounters, and the equipment used to track and record the craft favor the latter hypothesis that these are indeed technologically advanced craft. The observed flight characteristics of these craft are consistent with the flight characteristics required for interstellar travel, i.e., if these observed accelerations were sustainable in space, then these craft could easily reach relativistic speeds within a matter of minutes to hours and cover interstellar distances in a matter of days to weeks, proper time.

Keywords: UAP; UAV; UFO; *Nimitz*; Tic-Tac

1. Introduction

Unidentified Aerial Phenomena (UAPs) partially identified as being unknown anomalous aircraft, referred to as Unidentified Anomalous Vehicles (UAVs) or Unidentified Flying Objects (UFOs), have been observed globally for some time [1]. Such phenomena were studied officially by the United States Air Force in a series of projects: Project Sign (1947), Project Grudge (1949) and Project Blue Book (1952–1969) [2]. Other nations, such as Australia, Brazil, Canada, Chile [3], Denmark, France, New Zealand, Russia (the former Soviet Union), Spain, Sweden, the United Kingdom, Uruguay, and the Vatican have also conducted studies, or are currently studying, UAPs [4]. In December of 2017 it was revealed that the United States government had been studying UAPs through at least one secret program called the Anomalous Aerospace Threat Identification Program (AATIP) [5], and that there have been times at which United States Naval pilots have had to deal with nearly daily encounters with UAVs [6,7]. These unidentified craft typically exhibit anomalous flight characteristics, such as traveling at extremely high speeds, changing direction or accelerating at extremely high rates, and hovering motionless for long periods of time. Furthermore, these craft appear to violate the laws of physics in that they do not have flight or control surfaces, any visible means of propulsion apparently

Thanks to Kevin Day for calling it out that day. Thanks to Treavor for speaking out and Jeremy Corbell for making that interview. Thanks as well to Kevin Knuth, Peter Reali, and Richard Powell for making these papers.

So there's tons of evidence out there, guys. I made this video because I think we're focusing too much down into the little, the little gotchas. I think the skeptics and debunkers are able to frame the narrative here. Realize there is a ton of other data, there is a ton of information. . . .

CAM: Again, senior chief Kevin Day informed us that the ballistic missile defense radar systems had detected the UAPs in low Earth orbit BEFORE they dropped down to 80,000 feet. So think they also have contacts from the ballistic missile defense coming into 80,000 feet. The objects would arrive in groups of 10 to 20 and subsequently drop down to 28,000 feet with several hundred foot variation, and track south at a speed of about 100 knots.

Here is a question for the readers! Who do these belong to? The sheer numbers that are described implies a fleet. So whose fleet?

Ours = Secret Space Force

Not ours = Aliens

Ours + Aliens = Cooperation

Ours + Allies = Part of the Break Away Civilization

These are the only options. There can be no other explanation!

Why aren't these ship captains getting their nickers in a tizzy? I would if I genuinely didn't know what they were—coming in groups of 10 to 20 at a time. If I knew, then no big deal!

5. SOLAR WARDEN—THE SECRET SPACE PROGRAM

By Darren Perks, Investigative Researcher and Commentator

[huffingtonpost.co.uk/darren-perks/solar-warden-the-secret-space-program_b_1659192.html]

Updated September 10, 2012

Since approximately 1980, a secret space fleet code named "Solar Warden" has been in operation unknown to the public.

Is this nonsense, is it a conspiracy, or is it simply so sensitive that it will cause an uproar around the world?

These are my own words after conducting research into the secret program. Whilst conducting an FOI (freedom of information) request with the DoD (department of defense) in 2010, I had a very unexpected response by email from them which read:

About an hour ago I spoke to a NASA rep who confirmed this was their program and that it was terminated by the President. He also informed me that it was not a joint program with the DoD. The NASA rep informed me that you should be directed to the Johnson Space Center FOIA Manager.

I have run your request through one of our space-related directorates and I'm waiting on one other division with the Command to respond back to me. I will contact you once I have a response from the other division. Did NASA refer you to us?

The program not only operates classified under the US government but also under the United Nations authority. So you might be wondering, how do I know this information?

Well there are a few people, and many others, that have tried hard to find out the truth and have succeeded by leaked information or simply asking questions and have government departments slip up and give away information freely, just like what happened when [I] asked the DoD. One notable contributor is Gary McKinnon.

When Gary McKinnon hacked into U.S. Space Command computers several years ago and learned of the existence of "nonterrestrial officers" and "fleet-to-fleet transfers" and a secret program called "Solar Warden," he was charged by the Bush Justice Department with having committed "the biggest military computer hack of all time," and stood to face prison time of up to 70 years after extradition from the UK. But trying McKinnon in open court would involve his testifying to the above classified facts, and his attorney would be able to subpoena government officers to testify under oath about the Navy's Space Fleet. To date the extradition of McKinnon to the U.S. has gone nowhere.

McKinnon also found out about the ships or craft within Solar Warden. It is said that there are approximately eight cigar-shaped motherships (each longer than two football fields end-to-end) and 43 small “scout ships. The Solar Warden Space Fleet operates under the US Naval Network and Space Operations Command (NNSOC) [formerly Naval Space Command]. There are approximately 300 personnel involved at that facility, with the figure rising.

Solar Warden is said to be made up from U.S. aerospace Black Projects contractors, but with some contributions of parts and systems by Canada, United Kingdom, Italy, Austria, Russia, and Australia. It is also said that the program is tested and operated from secret military bases such as Area 51 in Nevada, USA.

So should we just write this off as utter nonsense? No, we shouldn't, and as time goes on the truth will slowly come out. Many people around the world are now witnessing craft moving around in the skies and subspace that completely defy gravity. Whether they are part of the Solar Warden secret program, military experimental aircraft, or not, thousands of people know what they see.

In my view Solar Warden is very real and a very strong possibility. So no, I don't think we should rule it out as complete nonsense.

Yes, it's a conspiracy because of all the hype and controversy surrounding the facts and information about the program.

Sensitive is an understatement. This program would change the world and our views on space exploration and travel, so no wonder that it would be kept a big 'secret'.

We should all keep it in the back of our minds . . . for now at least!

Read about my investigation work here:
ufoshropshire.co.uk

CAM: Now knowing that, there are aliens, what do you think the likelihood of the above is true?

6. THE UNITED STATES PATENT FOR THE TR-3B AND THE TR-3B IN FLIGHT.

The TR-3B is a Triangular Spacecraft that has been developed by the United States. It is flying now and there are reports of it having been seen as early as 1990. There are at least two since they were seen and filmed flying together.

CAM: This spaceship is real. It is the model that is being used for disclosure to the public. It is a **false flag event** in order to buy as much time as possible for the powers in charge. We already have a fleet of interstellar ships. Again, here are statements by Ben Rich.

Ben Rich: “We already have the means to travel among the stars, but these technologies are locked up in black projects and it would take an act of God to ever get them out to benefit humanity.”
[Source: Statement made after UCLA presentation to three Disclosure Project witnesses.]

Ben Rich: “Jim, we have things out in the desert that are fifty (50) years beyond what you could possibly comprehend. If you have seen it on Star Wars or Star Trek, we've been there done that, or decided it was not worth the effort.”

[Source: Direct comments by Ben Rich to Jim Goodall via telephone call at the USC medical center approximately one week before Ben passed away on January 5, 1995.]

CAM: There are two programs of disclosure.

1. The United States has already achieved interstellar travel per Ben Rich.
2. Now we are in the process of slow disclosure that will one day coincide with what we have really achieved. There are too many clues that we achieved interstellar travel decades ago.

We're still in the process of discovery with their technology, and that is why we have only solved one or two of the propulsion systems that are out there. I think that we have a handle on the Plasma Mercury 199 system. I think that this is what drives the TR-3B. We haven't made progress on the most sophisticated systems because the ETs are not going to let us have that technology until we learn how to behave as a species.



Cell phone video, 2013.*



TR-3B ,Paris, France, 2011.



TR-3B at night.



TR-3B at night.



TR-3B,; Pittsburg ,PA, USA, 2009.



TR-3B, Reutlingen, Germany, 2013.

Screen shots from cell phone videos of TR-3B sightings.
See Lifeboat Foundation: Safeguarding Humanity at lifeboat.com/blog/2019/05/the-tr-3b-is-real
*[youtube.com/watch?v=1sX4DgOmrWs](https://www.youtube.com/watch?v=1sX4DgOmrWs). Watch the very beginning and you can see the TR-3B flying between the 2 jets.



US 20060145019A1

(19) **United States**

(12) **Patent Application Publication**
St. Clair

(10) **Pub. No.: US 2006/0145019 A1**

(43) **Pub. Date: Jul. 6, 2006**

(54) **TRIANGULAR SPACECRAFT**

Publication Classification

(76) Inventor: **John Quincy St. Clair**, San Juan, PR
(US)

(51) **Int. Cl.**
B64G 1/40 (2006.01)

(52) **U.S. Cl.** **244/171.5**

Correspondence Address:
JOHN ST. CLAIR
52 KINGS COURT, 4A
SAN JUAN, PR 00911 (US)

(57) **ABSTRACT**

A spacecraft having a triangular hull with vertical electrostatic line charges on each corner that produce a horizontal electric field parallel to the sides of the hull. This field, interacting with a plane wave emitted by antennas on the side of the hull, generates a force per volume combining both lift and propulsion.

(21) Appl. No.: **11/017,093**

(22) Filed: **Dec. 20, 2004**

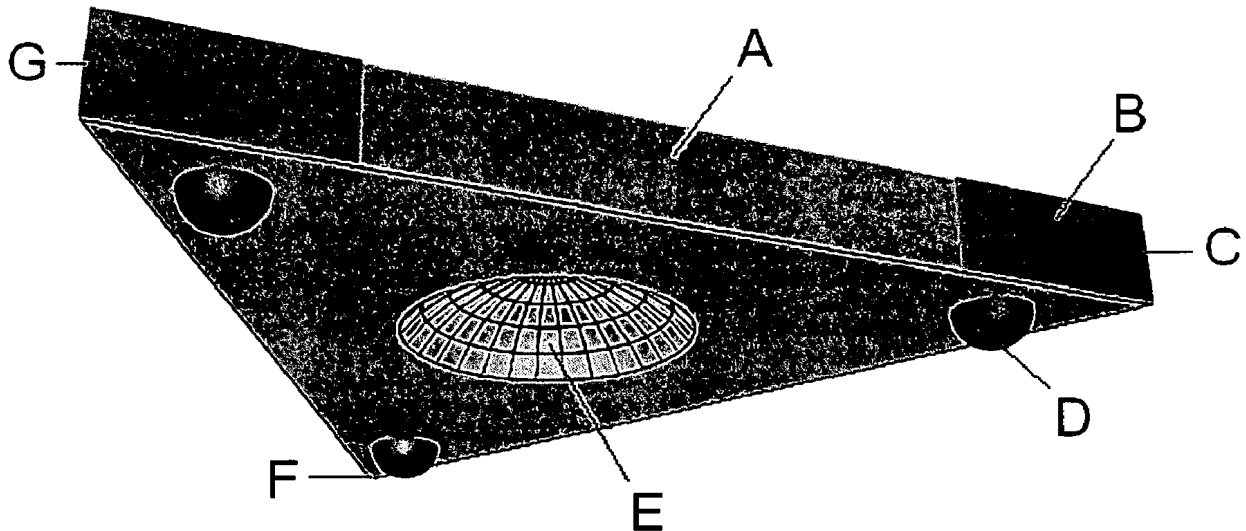

Figure 1

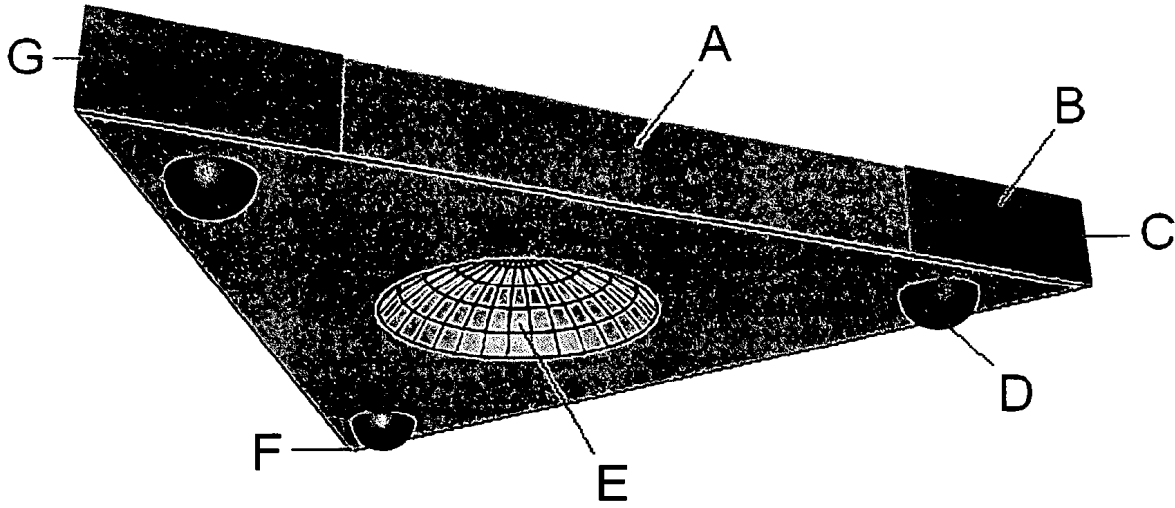

Figure 2

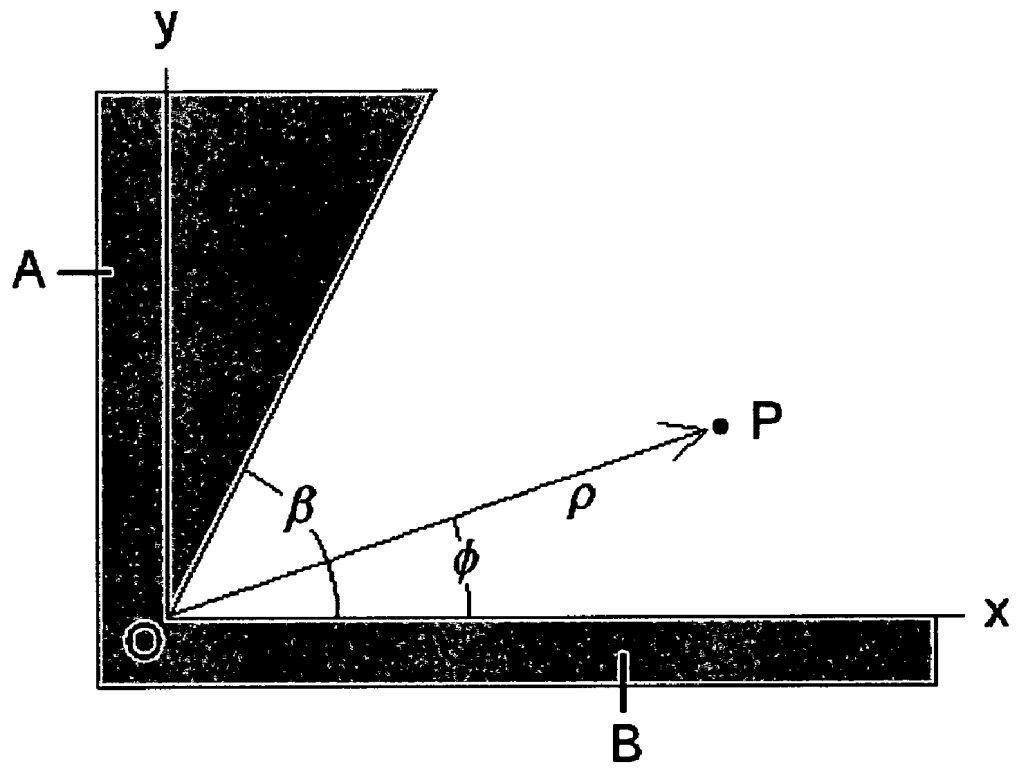

Figure 3

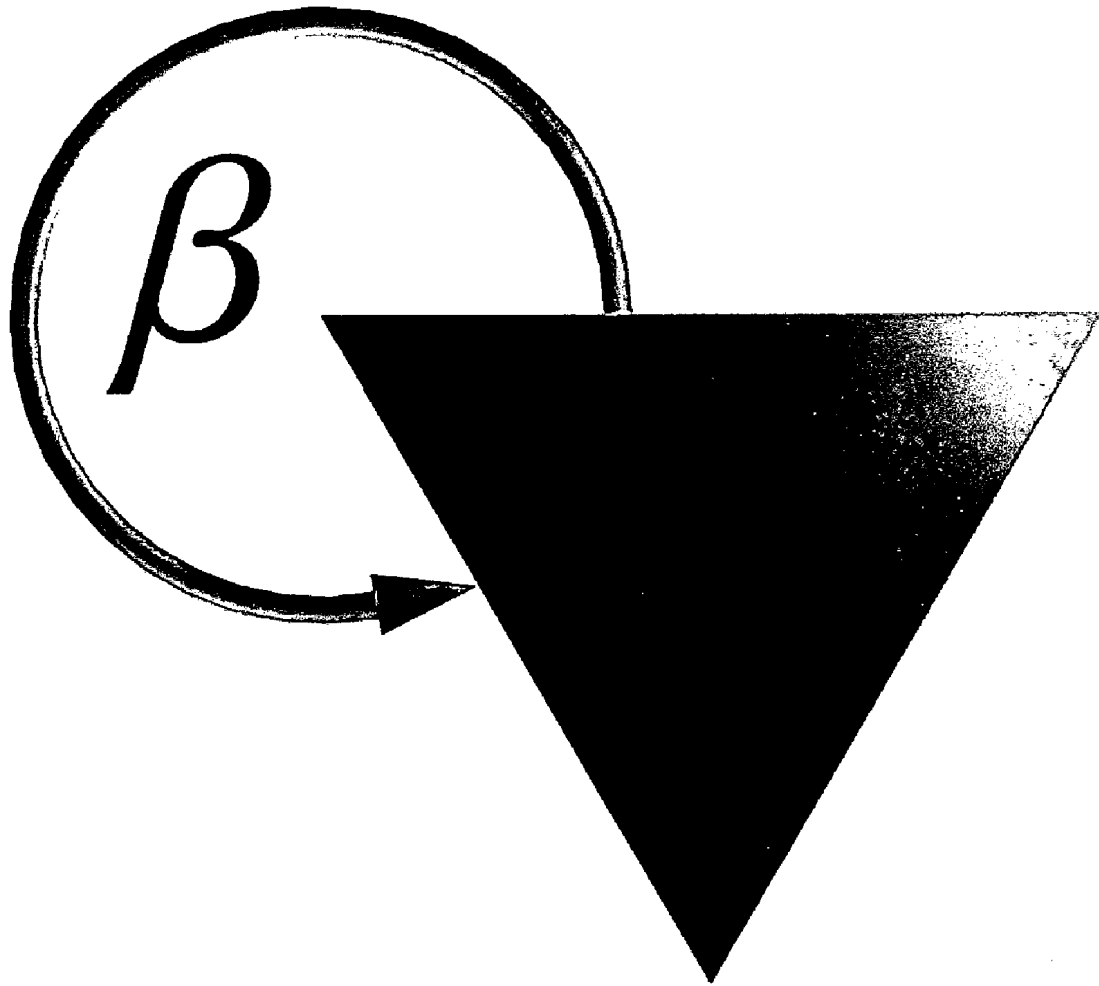

Figure 4

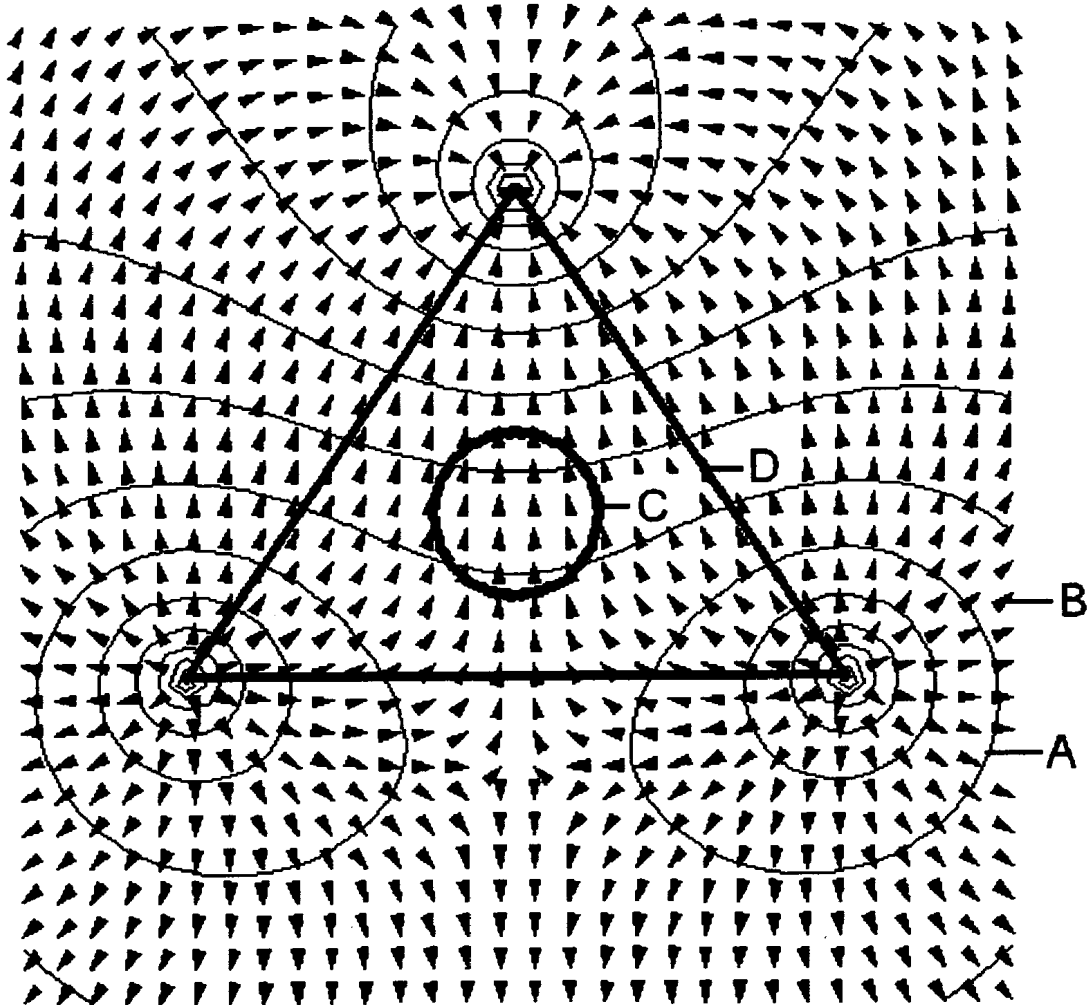

Figure 5

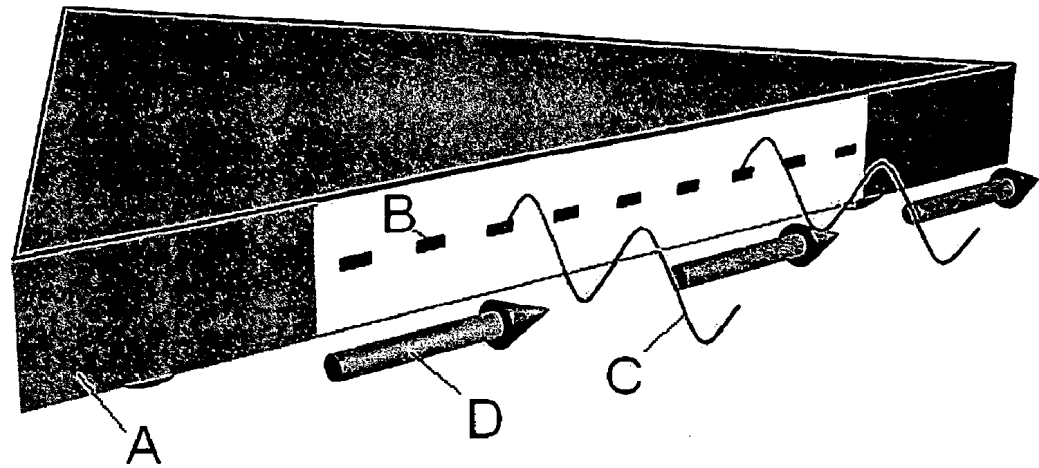

Figure 6

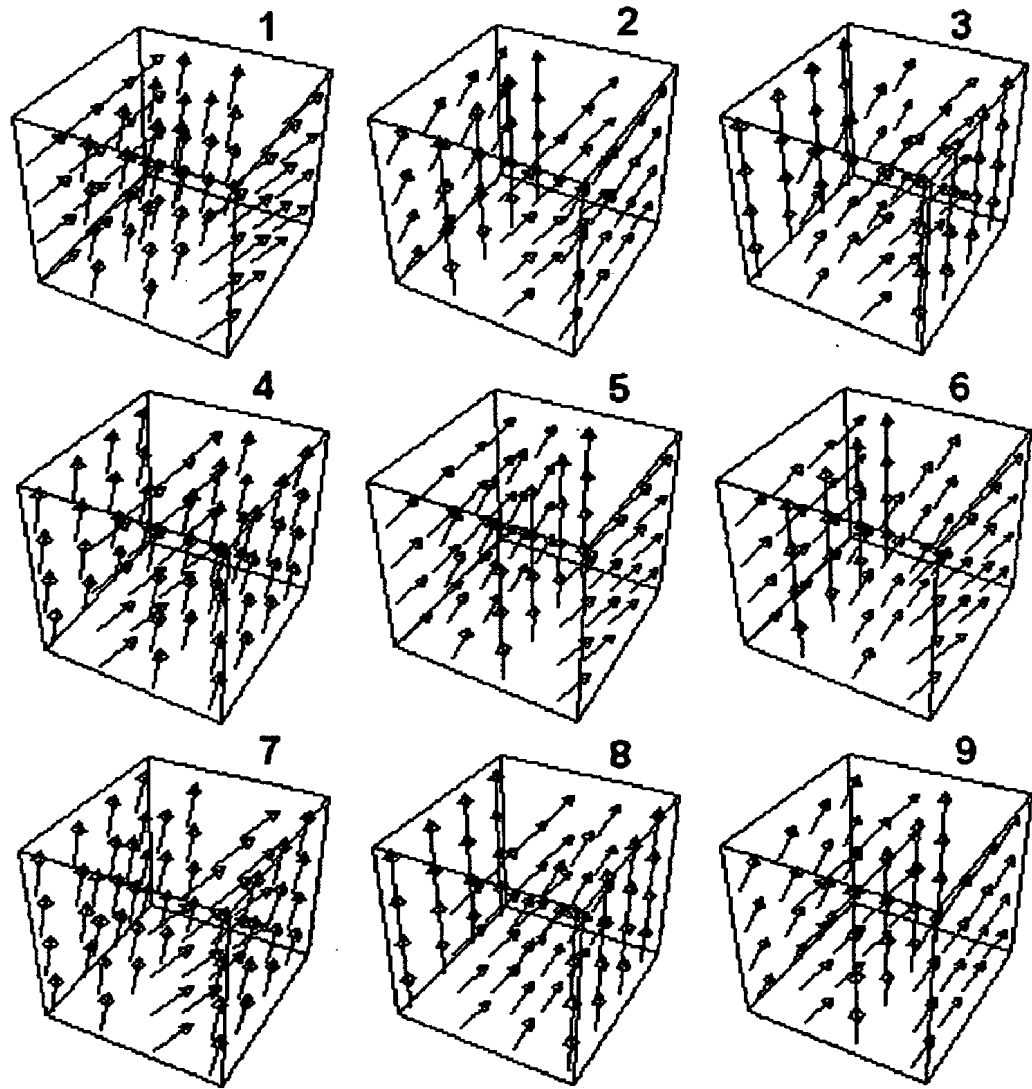
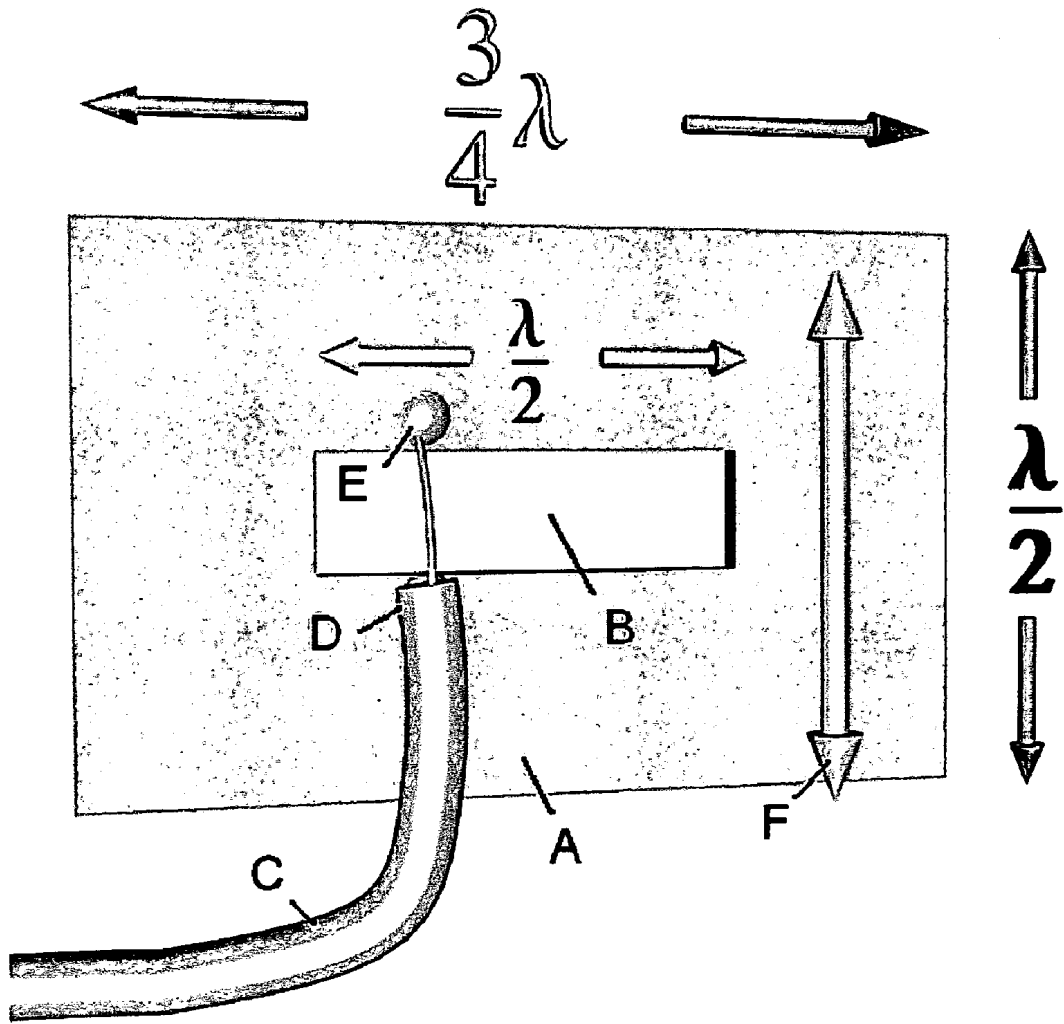

Figure 7



TRIANGULAR SPACECRAFT

BRIEF SUMMARY OF THE INVENTION

[0001] This invention is a spacecraft having a triangular hull with vertical electrostatic line charges on each corner. The line charges create a horizontal electric field that, together with a plane wave emitted by antennas on the side of the hull, generates a force per volume providing a unique combination of both lift and propulsion.

BACKGROUND OF THE INVENTION

[0002] Referring to **FIG. 1**, the spacecraft has a hull in the shape of an equilateral triangle. A parabolic antenna (E) is centrally located in the bottom of the hull. An array of horizontal slot antennas is located along the side of the hull (A). Each back corner (F,G) has a corner conducting plate which is charged to a positive voltage +V. The forward corner (C) has a conducting plate charged to a negative voltage -V. A motion control hemisphere (D) is located on the bottom surface in each of the three corners.

[0003] Referring to **FIG. 2**, two planes (A,B) intersect at the origin O at an opening angle β . Each plane (x,y) is charged to a voltage V. The potential at point P is determined in polar coordinates $\{\rho,\phi\}$. The Laplace equation for the potential Φ in polar coordinates is given by:

$$\frac{1}{\rho} \frac{\partial}{\partial \rho} \left(\rho \frac{\partial \Phi}{\partial \rho} \right) + \frac{1}{\rho^2} \frac{\partial^2 \Phi}{\partial \phi^2} = 0$$

Using a separation of variables solution, the potential is given as the product of two functions:

$$\Phi(\rho,\phi) = R(\rho)\Psi(\phi)$$

which when substituted into the Laplace equation becomes:

$$\frac{\rho}{R} \frac{d}{d\rho} \left(\rho \frac{dR}{d\rho} \right) + \frac{1}{\Psi} \frac{d^2 \Psi}{d\phi^2} = 0$$

Since the two terms are separately functions of ρ and ϕ respectively, each one has to be constant with the sum of the constants equal to zero:

$$\frac{\rho}{R} \frac{d}{d\rho} \left(\rho \frac{dR}{d\rho} \right) = v^2 \quad \frac{1}{\Psi} \frac{d^2 \Psi}{d\phi^2} = -v^2$$

These two equations have solutions:

$$R(\rho) = a\rho^{v+1} + b\rho^{-v}$$

$$\Psi(\phi) = A\cos(v\phi) + B\sin(v\phi)$$

The azimuthal angle ϕ is restricted to a value in the range $0 \leq \phi \leq \beta$. The boundary condition is that the potential Φ is equal to V for any radius ρ when $\phi=0$ and $\phi=\beta$. This means that v has to be an integer value of π so that the sine function is zero:

$$\sin(v\beta) = \sin\left(\frac{m\pi}{\beta}\beta\right) = \sin(m\pi) = 0 \quad m = 1, 2, \dots$$

which in turn means that the coefficient A of the cosine term has to be zero in the solution above. Choosing $b=0$ makes the general solution for the potential equal to:

$$\Phi(\rho, \phi) = V + \sum_{m=1}^{\infty} a_m \rho^{m\pi/\beta} \sin(m\pi\phi/\beta)$$

which shows that when the angle is zero, the sine is zero and the potential is V. If the angle is β , then there is a multiple of π such that the sine is zero again.

[0004] Because the series involves positive powers of the radius, for small enough ρ , only the first term $m=1$ in the series is important. Thus around $\rho=0$, the potential is approximately

$$\Phi(\rho,\phi) \approx V + a_1 \rho^{\pi/\beta} \sin(\pi\phi/\beta)$$

[0005] The electric field component is the negative gradient of the potential:

$$E_\phi(\rho, \phi) = -\frac{1}{\rho} \frac{\partial \Phi}{\partial \phi} = -\frac{\pi a_1}{\beta} \rho^{(\pi/\beta)-1} \cos(\pi\phi/\beta)$$

The surface charge distribution σ at $\phi=0$ and $\phi=\beta$ is equal to the electric field perpendicular to the surface times the permittivity of space ϵ_0 :

$$\sigma(\rho) = \epsilon_0 E_\phi(\rho, 0) = -\frac{\epsilon_0 \pi a_1}{\beta} \rho^{\frac{\pi}{\beta}-1}$$

Notice that if angle of intersection β is less than π , then the equation says that there is a very small radius to a positive power which means little charge density accumulation.

[0006] Referring to **FIG. 3**, the value of β , in the case of the triangular hull, is equal to 360° less 60° for a total of 300° or:

$$\beta = \frac{300}{180}\pi = \frac{5}{3}\pi$$

$$\rho^{\frac{\pi}{3\pi}-1} = \frac{1}{\rho^{\frac{2}{3}}}$$

which says that there is a charge density singularity to the two fifths power for small radius. Thus, the corner plates on the hull create a huge line charge density along the sharp vertical corner edge. The equation for the potential of a line charge density is given as:

$$\Phi(x, y) = -\frac{\lambda}{2\pi\epsilon_0} \text{Ln}((x-x_0)^2 + (y-y_0)^2)$$

where λ is the charge per unit length in the vertical z-direction, and x_0 and y_0 are the location of the line charge in the xy-plane.

[0007] Referring to FIG. 4, the triangular hull (D) is plotted together with the potential contours (A) and the electric field arrows (B) created by the three corner line charges. The line charges are perpendicular to the paper. Notice that the electric field arrows are parallel crossing the center parabolic antenna (C). The electric field is also parallel to the sides (D) of the triangle.

[0008] Referring to FIG. 5, along the side of the triangle (A), an array (B) of horizontal slot antennas emit electromagnetic waves that have a vertically polarized electric E field (C). These traveling waves interact with the electric field (D) produced by the line charges on the corners of the triangle.

[0009] Using differential forms mathematics, this combination of fields is represented by the Hodge star of the differential of the wedge product of the two fields. The antenna electromagnetic field is a combination of a traveling magnetic field B_w , and electric field E_w . The stationary field E created by the line charges is perpendicular to the traveling wave.

$$*d(E \wedge (B_w + E_w \wedge dt)) \frac{\epsilon}{c} = \frac{\text{force}}{\text{volume}}$$

where ϵ is the linear capacitance of space and c is the speed of light. Thus there is a force per volume around the hull.

[0010] This combination of fields produces a spacetime curvature as determined by Einstein's General Theory of Relativity. The traveling electric field has an amplitude in the vertical z-direction and travels in the x-direction

$$E_{w-E_z \cos(x-t)}$$

The Faraday electromagnetic tensor contains all the electric and magnetic fields in all the {x,y,z} directions. The first row and first column contain the two electric fields

$$F_{\beta}^{\alpha} = \begin{vmatrix} t & 0 & E_x & 0 & E_z \cos(x-t) \\ x & E_x & 0 & 0 & 0 \\ y & 0 & 0 & 0 & 0 \\ z & E_z \cos(x-t) & 0 & 0 & 0 \end{vmatrix}$$

The stress exerted on spacetime occurs in the xx, yy and zz-direction as calculated from the stress-energy tensor T of gravitational physics

$$4\pi T^{\mu\nu} = F^{\mu\alpha} F_{\alpha}^{\nu} - \frac{1}{4} g^{\mu\nu} F_{\alpha\beta} F^{\alpha\beta}$$

where g is the metric tensor for Cartesian space

$$g_{\alpha\beta} = \begin{vmatrix} t & -1 & 0 & 0 & 0 \\ x & 0 & 1 & 0 & 0 \\ y & 0 & 0 & 1 & 0 \\ z & 0 & 0 & 0 & 1 \end{vmatrix}$$

where the diagonal components are the coefficients of the elementary spacetime length ds squared

$$(ds)^2 = -(dt)^2 + (dx)^2 + (dy)^2 + (dz)^2$$

The calculation produces three stresses T^{xx}, T^{yy} and T^{zz} in their respective {x,y,z} directions.

[0011] Referring to FIG. 6, these three stresses are plotted together as a 3D vector field animated over time in nine frames. The graphs show that there is a lift force as depicted by the vertical arrows as well as a force of propulsion as shown by the interspersed horizontal arrows. With the passage of time, these vectors exchange places with each other so that the lift becomes the propulsion and vice versa, creating a wavy stress-energy field around the hull.

SUMMARY OF THE INVENTION

[0012] This invention is a spacecraft with a triangular hull having charged flat plates on the vertical corners of the three sides. The two rear corners are charged to a potential V. The forward corner is charged to a potential -V. The 60° angle on the corner creates a line charge density singularity that produces a huge horizontal electric field pointing from the back to the front of the craft which is also parallel to the sides of the triangle. An array of horizontal slot antennas located on the sides of the triangular hull produce an electromagnetic wave with the electric field polarized in the vertical direction. This combination of fields produces a spacetime force in both the vertical and horizontal directions such that the spacecraft receives a lift force and a force of propulsion.

A BRIEF DESCRIPTION OF THE DRAWINGS

- [0013] FIG. 1. Perspective view of triangular spacecraft.
- [0014] FIG. 2. Drawing of the intersection of two charged plates in order to calculate the charge density in the corner.
- [0015] FIG. 3. Perspective view of the corner angle β for the equilateral triangle.
- [0016] FIG. 4. Planar 2D graph showing the electric field produced by three line charges on the corners of the triangular hull.
- [0017] FIG. 5. Perspective view of electric field produced by the linear charge interacting with the traveling electromagnetic wave produced by the slot antenna.
- [0018] FIG. 6. 3D vector animation of the lift and thrust force generated by the fields.
- [0019] FIG. 7. Perspective view of slot antenna.

DETAILED DESCRIPTION OF THE INVENTION

[0020] Referring to FIG. 7, the antenna (A) is made out of sheet copper in which a rectangular horizontal slot (B) has been notched out using a die press and sheet metal fixture. A coaxial cable from the amplifier and frequency generator is attached across the slot by soldering the outer cable (D) to one side of the slot and the inner cable (E) to the other side of the slot. This creates the positive and negative charges across the gap which forms the vertical electric field (F) which radiates out perpendicularly to the copper sheet.

[0021] Although the invention has been described with reference to specific embodiments, such as a particular antenna system, those skilled in the art will appreciate that many modifications and variations are possible without departing from the teachings of the invention. All such modifications and variations are intended to be encompassed within the scope of the following claims.

1. A spacecraft comprised of the following components:

- (a) a triangular hull in the form of an equilateral triangle;
- (b) two copper plates attached on opposite vertical sides at each of the three corners of the hull (1a) such that a sharp vertical edge is formed where they come together;
- (c) an electrostatic generator used to charge the back two copper-cladded corners (1b) to a high positive voltage, and the third forward copper-cladded corner to a high negative voltage;

(d) a horizontal slot antenna array mounted-on the sides of the hull; and

(e) a frequency generator, antenna and coaxial cables to drive the antenna array (1d).

2. To create, by claims (1a, 1b, 1c), an intense vertical line charge at the corners (1b) and a horizontal electric field that that is parallel to the sides of the hull (1a);

3. To create, by claims (1d,1e), an electromagnetic wave with a vertically polarized electric field traveling outward from the side of the hull (1a); and

4. To create, by claims (2,3), an interaction of the electrostatic field (2) with the electromagnetic wave (3) such that a combined spacetime curvature pressure is generated on the hull in the upward and forward direction to produce lift and propulsion respectively.

* * * * *

The United States patent application for the TR-3B, page 11 of 11.



Two TR-3Bs and a drone, USA, 2013.



Two TR-3Bs, USA, 2013.

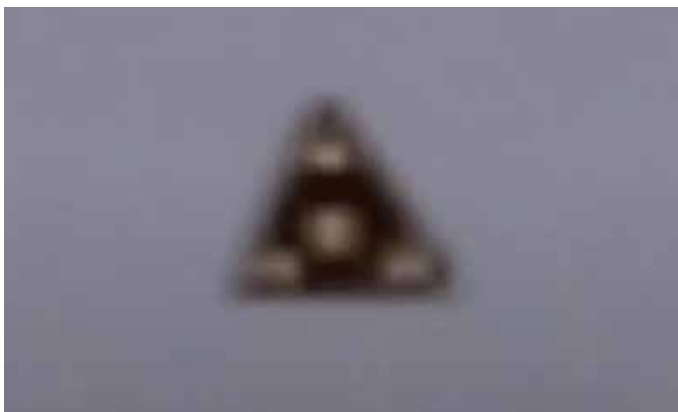

TR-3B close up, USA, 2013.



TR-3B,; Kassel, Germany, 2014.

Screen shots from cell phone videos of TR-3B sightings.

See Lifeboat Foundation: Safeguarding Humanity at lifeboat.com/blog/2019/05/the-tr-3b-is-real

This page has no content.

UFOs and Nukes: The Secret Link Revealed

Robert Hastings is a UFO researcher, lecturer, author, and filmmaker who has researched declassified US government documents which confirm that UFO incursions at nuclear research sites occurred as early as 1945, before the end of World War II. Hastings interviewed more than 150 U.S. Air Force veterans who were involved in one or more of those incidents.



Robert Hastings

In this section, U.S. government documents reveal UFO incidents at American nuclear missile sites. Documents smuggled out of Russia expose similar incidents at Soviet missile sites. Military veterans from both countries are now confirming these events.

(Source: Transcription of Gaia.com documentary UFOs and Nukes: The Secret Link Revealed.)

The invention of nuclear weapons ranks as one of the key developments in human history. For the first time all-out warfare risked not only the destruction of civilization, but the radioactive poisoning of the planet itself. America's attacks against the Japanese cities of Hiroshima and Nagasaki in August 1945 demonstrated that the catastrophic effects of even a small atomic bomb were horrific in the extreme. After the atomic bomb blast that virtually erased the city of 340,000 from this Earth, as far as the eye can see stretched scenes of desolation and ruin. Four square miles leveled by one bomb.

Fearing widespread destruction in the days ahead, and shocked by the simultaneous invasion of its territory by the Soviet Union, the Japanese government finally surrendered, thereby ending World War II.

Less than a year later the U.S. military detonated two more atomic bombs during Operation Crossroads, conducted at the newly created Pacific Proving Grounds. By then the Soviets, once allies of the U.S., were considered a threat to Western democracies in the postwar world. President Harry S. Truman and his advisors concluded that America's possession of large numbers of atomic weapons would keep the Russian communists in check, and authorized crash programs devoted to ongoing testing and mass production.

On August 29, 1949, the Soviet Union detonated its own atomic bomb, much sooner than expected. The nuclear arms race had begun in earnest. To make matters worse, by the early 1950s the newly invented hydrogen bombs—some of them a thousand times more powerful than atomic weapons—began to be tested in remote areas of the planet by the new nuclear superpowers and their allies. Mankind's future never looked bleaker.

Intriguingly, this grim state of affairs led to an (at that time) unexplained mystery. As difficult as this will be for some people to accept, evidence uncovered by researchers confirms that technologically advanced observers, whose identity and

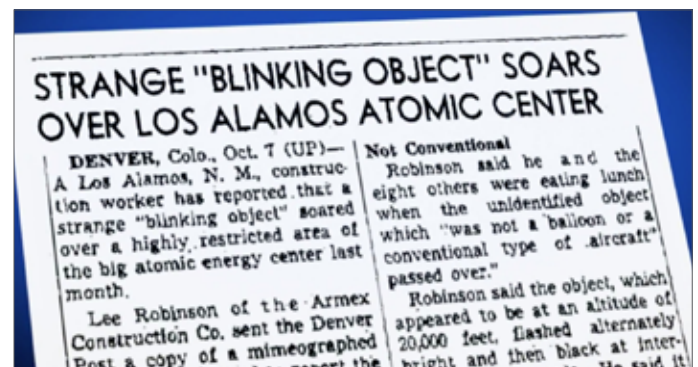
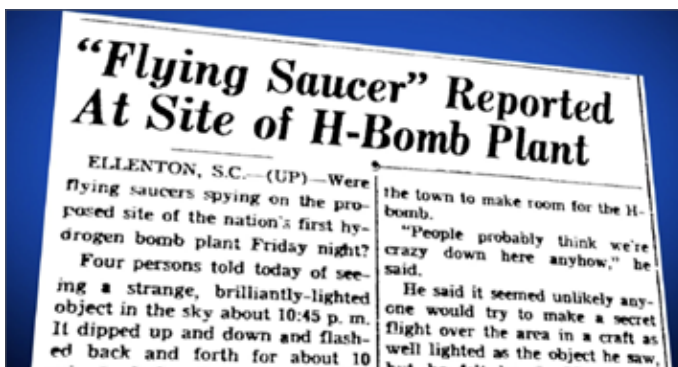

Newspaper reports of UFO incidents.

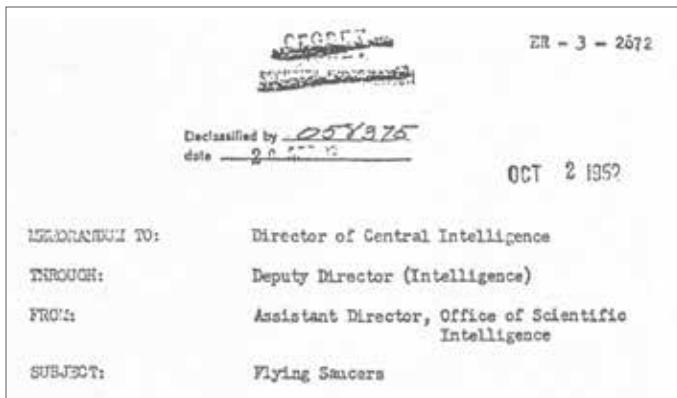

Declassified memorandum. Subject: Flying Saucers.

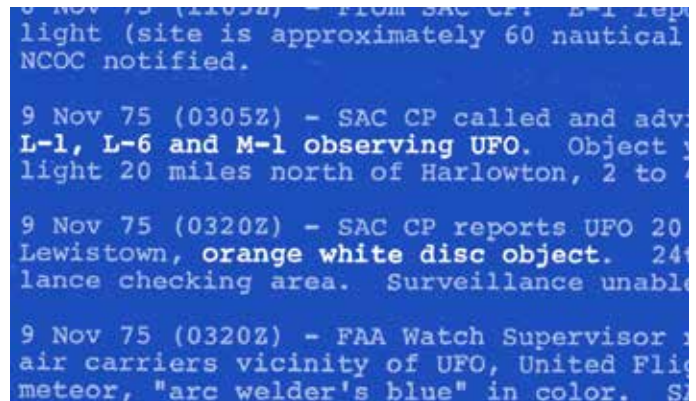

Office Memorandum.

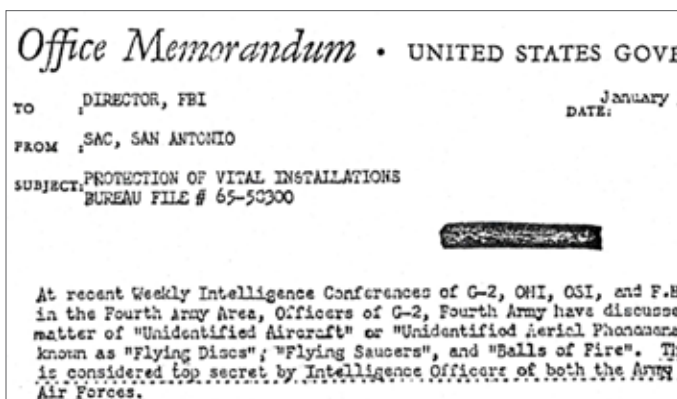

Office Memorandum mentioning flying discs and saucers.



UFOs and Nukes press conference, September 27, 2010.

intentions remain unknown, began to monitor the nuclear standoff, almost from the start.

Declassified US government documents reveal that as early as December 1948 incursions by mysterious aerial objects, later referred to as UFOs, began to occur at American nuclear laboratories, bomb storage depots, weapons test areas, and, as time went on, intercontinental ballistic missile sites.

Particularly dramatic are the incidents now being openly discussed by former US Air Force ICBM launch officers who were stationed at various Strategic Air Command (SAC) bases in the 1960s and 70s. According to these highly credible witnesses, on some occasions, as the UFOs briefly hovered over their launch facilities, the nuclear missiles inexplicably malfunctioned. The officers had been on alert in their underground launch control capsules when they received telephone calls from their security guards at ground level saying that they were observing one or more unidentified disk shaped craft maneuvering in the sky. Seconds later,

as many as 10 ICBMs suddenly shut down, according to warning lights on the officers' missile readiness consoles, meaning that they could not have been launched if the President of the United States had, at that moment, ordered a nuclear attack on America's adversaries.

These witnesses say that their superiors ordered them to keep quiet about the incidents and, in some cases, required them to sign non-disclosure statements, which stipulated severe legal penalties for anyone who violated secrecy. As a result of the harsh security measures imposed upon them many of these Air Force veterans waited decades before discussing the nearly unbelievable and highly disturbing incidents they had observed. Nevertheless, a number of them have finally stepped forward to reveal the truth.

On September 27, 2010, a leading UFO researcher Robert Hastings and a former Minuteman missile launch officer Robert Salas co-sponsored the UFOs and Nukes press conference in Washington, DC, in an effort to bring the facts to the public. The



Robert Salas

event was widely covered by the media, not only in the United States, but around the world. CNN streamed it live, and other major news organizations published stories about it later that same day.

Robert Salas: Good afternoon, My name is Robert Salas. In 1967 I was a first lieutenant stationed at Malmstrom Air Force Base, Montana. I was a missile launch officer. Sometime in the evening hours, on March 24, I received a call from one of my top-side guards, the flight security controller, stating that they had been observing strange lights in the sky making odd maneuvers. He called back five minutes later. This time he was screaming into the phone, saying they're looking at a red glowing object hovering just above our front gate. Our missiles began going into what's called a no-go condition, or unlaunchable. Essentially they were disabled while this object was still hovering over our site.

Lt. Col. Dwyne Arneson (USAF retired): Back in 1967 I was the officer in charge of the communications center at the 28th Air Division in Great Falls,

Montana. In March of that particular year I can clearly recall a message coming through my communications center which basically said that a UFO did in fact shut down several missile silos in Montana.

Robert Hastings has devoted 40 years to seeking out and interviewing US military veterans regarding their UFO experiences at missile sites and other nuclear weapons facilities. His book *UFOs and Nukes* contains the testimony of more than a 100 individuals.

Robert Hastings: Declassified US government documents and witness testimony from former or retired US military personnel confirm beyond any doubt the reality of ongoing UFO incursions at nuclear weapons sites. [CAM: This is still happening today out over our ships.]

Capt. Bruce Fenstermacher (USAF Ret.): "In 1976, I was the Minuteman-III combat crew commander at F. E. Warren Air Force Base, Wyoming. In 1976 my deputy, Bill, and I were on alert. We contacted our FSE, or Flight Security Officer, and asked him, was there something wrong? And he said right above him was a big white object that was cigar shaped, 80 to 100 feet above him, 40 to 50 feet long." [CAM: This is what David Fravor described as a Tic-Tac of the same size.]

"I said okay, keep me abreast of what is happening. It stayed there about a minute, minute and a half, and it slowly and very silently moved along the access road. When we came up the next morning the FSC was in his chair in a fetal position. And we talked to him and tried to calm him down. We couldn't calm him down oddly enough. We were called in by the



CBS News article, September 28, 2010.



News articles in response to the UFOs and Nukes press conference.



Russian UFO drawing.

squadron commander again. And he took whatever notes my deputy had, tore them up. So this didn't happen! It's top secret. And made us sign something.”

Significantly, dramatic UFO incidents were also occurring at nuclear missile facilities in the former Soviet Union, including cases where the weapons suddenly malfunctioned. Documents obtained in Russia by Western journalists in the 1990s as well as on-the-record statements by Soviet army veterans summarize the unsettling events in great detail.

These revelations made clear that both American and Soviet nuclear missiles were subjected to ongoing surveillance, and from time to time deliberate tampering by whoever was piloting the UFOs during the long, tense confrontation known as the Cold War. Had that anxious standoff between capitalism and communism suddenly become a hot nuclear war, hundreds of millions of people would have been killed outright, and a great many more, perhaps 1 to 2 billion worldwide, would have died over time, the result of radiation illness, exposure, and mass starvation. Indeed, a great many species and ecosystems on Earth would have been devastated by such a war.

But what were the mysterious missile disruptions, as described by American and Soviet military veterans, meant to convey? Were they a demonstration of the unknown observer's ability to interfere with these weapons at will? If so, would they have openly intervened to try to prevent a nuclear exchange from occurring if hostilities seemed imminent? To state the obvious, the answer to these questions remain elusive even now. [CAM: To me it says “we're not going to let you use them,” is the only reasonable conclusion there is.]

But if all of this is true, what exactly is going on? Who or what is piloting the amazing aerial craft we call UFOs? And why do they seemingly have an intense interest in monitoring and sometimes disrupting our nuclear weapons systems? [CAM: Again, the answer is obvious they're NOT going to let us use them. Would you if you had the kind of power they do? No not a chance!]

A brief review of the evidence may provide a few clues. US government documents released through the Freedom of Information Act confirm that unidentified aerial objects, described as “flying disks,” and “flying saucers,” began to be sighted around the Los Alamos Atomic Laboratory in New Mexico, the birthplace of nuclear weapons as early as December 1948.

Three years earlier on July 16, 1945, the lab had tested the first atomic bomb in the desert near Alamogordo, just weeks before the devastating attacks against Japan. Although shrouded in secrecy for decades, the declassified documents reveal that UFOs appeared with alarming frequency—not only at Los Alamos, but also at its sister laboratory, Sandia, in Albuquerque, throughout the 1950s.



Sight Flying Saucers Over Los Alamos Base.



Work Crew Spots Flying Saucers Over A-Test Site.



Illustration of P-51 Mustang chasing a UFO.

Other declassified documents discuss ongoing UFO sightings at the Oak Ridge Nuclear Laboratory in Tennessee, the Hanford Plutonium Processing Plant in Washington state, and the Savannah River Complex (another plutonium manufacturing site) in South Carolina.

While the local and even national media occasionally published stories about these incidents, the vast majority of the American public had no idea that they were so frequent and widespread.

Nevertheless, according to military intelligence officers a worrisome pattern had begun to emerge. On July 1, 1952, *Look* magazine featured an article, "Hunt for the Flying Saucer," about the Air Force's new UFO investigations group, Project Blue Book, and noted that its director, First Lieutenant Edward Ruppelt had plotted 63 unexplained sightings on a map of the United States. At that point, it was discovered that an "ominous correlation" existed



Hunt for the Flying Saucer.



5 Nevada Men See Saucers

between some of the sightings and the location of various atomic weapons installations.

Later that year the CIA took notice of the situation, as this memorandum reveals. Dr. H. Marshall Chadwell, assistant director of the agency's Office of Scientific Intelligence wrote, "Sightings of unexplained objects and great altitudes, and traveling at high speeds in the vicinity of major US defense installations are of such nature that they are not attributable to natural phenomena or known types of aerial vehicles."

UFOs also visited the newly created Nevada Proving Ground, located 60 miles northwest of Las Vegas, where new and improved atomic devices were being tested. Civilians living near the proving ground often observed the aerial disks, sometimes flying in large formations and subsequently notified the Air Force and the local media.

At the same time, US army personnel engaged in field maneuvers at the test site, designed to expose



Hydrogen bomb.



Lt. Col. Philip Moore (USAF Ret)

them to atomic battlefield conditions, also reported seeing the UFOs.

Meanwhile, other sightings were occurring at the remote Pacific proving grounds, where ongoing tests of the far more destructive hydrogen bombs were taking place, as the US tried to outpace the Soviets in the new technology of warfare.

The chief purpose of the nuclear tests was to create a powerful, but lightweight, bomb that could be easily transported aboard an aircraft—the primary delivery system during that era. Had the United States been attacked by the Soviet Union, the US Air Force planned to launch hundreds of strategic bombers against that country and its communist allies. Flying over the Arctic region, they would deliver their deadly payloads a few hours later. At the same time, Soviet bombers would be racing toward North America and Western Europe, carrying their own hydrogen bombs, intent on massive retaliation. If this were not enough, the nuclear standoff entered a new and even more menacing phase in the early 1960s with the first deployment of intercontinental ballistic missiles. Traveling at more than 15,000 miles per hour, these space age weapons could deliver their massively destructive warheads to targets on the other side of the globe in less than half an hour. That shockingly brief period was later reduced to less than ten minutes, once US and Soviet missile-carrying submarines began to be deployed just off each other's coasts. Nuclear Armageddon, if it came to pass, would burst upon the world with sudden savagery, against which there would be no possible defense.



Lt. Col. Philip Moore (USAF Ret), Walker AFB, NM, 1964

Perhaps predictably, declassified documents reveal that UFO sightings at nuclear missile launch facilities began to occur as early as 1962.

Lt. Col. Philip Moore (USAF Ret.), Walker AFB, New Mexico, 1964: My crew was on alert at missile complex seven. Major Gilbert, my crew commander, and I were manning the launch console. We got a call from the site six crew commander saying that there's something hovering above his site, and he asked us to go topside and see what we could see. So Major Gilbert sent our three enlisted men to what we call the cap, which was the topside of the launch control center. They reported to us that they saw a light above site six that rapidly accelerated and stopped instantly above the area where sight eight was located and went back and forth. It was instant go, instant stop. That object did things that no airplane, helicopter, or any other system that we had in existence could do. It had to be not of this Earth.

Air Force security personnel guarding these sensitive sites reported seeing unknown aerial objects, usually described as disk shaped, maneuvering at low altitude, and sometimes even hovering over launch silos and launch control facilities at every ICBM base in the United States.

Often the UFOs were tracked on radar performing maneuvers vastly beyond the capability of any manmade aircraft. Experienced radar personnel were stunned as the objects flew thousands of miles per hour, made sharp-angled turns, and instantly stopped in midair.

They mysterious intruders were frequently chased by Air Force interceptors, which had been



Lieutenant Robert Jacobs

scrambled to protect the missiles, from possible sabotage. So far as is known, the UFOs always escaped unscathed, usually by vastly increasing their speed and leaving the fighters far behind. Baffled military officials had to deal with these unexplained and alarming incidents on an ongoing basis, while trying their best to keep the facts from leaking out to their fellow Americans, many of whom believed the UFO phenomenon to be a nonsensical subject, having no basis in reality.

This skeptical attitude was actively fostered by the government's own policy of ridicule and denial, as implemented by members of Project Blue Book, who routinely dismissed credible, bona fide UFO sightings as the misidentifications of natural phenomena or manmade aircraft. Over time this practice led to widespread public backlash against the US government and its weak and sometimes ridiculous explanations for the sightings.

Meanwhile, behind the scenes, UFOs began to appear at missile test ranges, often during launches designed to improve the performance and reliability of America's ICBMs and the deadly warheads they carried. Occasionally those aboard the UFOs did more than watch the tests. While the exact date remains uncertain, sometime in the fall of 1964 an incident occurred at Vandenberg Air Force Base, California, which has come to be the best known, most astonishing example of deliberate UFO interference with our nuclear weapons systems. Although the case is still classified top secret, a former Air Force officer, Dr. Robert Jacobs, has openly discussed it. At the time, Lieutenant Jacobs, who was assigned to the 1369th photographic squadron and held the title Officer in Charge of Photo Instrumentation, was

tasked with filming missile launches from a remote mountaintop site on California's Big Sur coastline using a powerful telescopic camera. The ascending ICBMs would initially fill the camera frame permitting a detailed view of engine performance, staging, and other aspects of a given launch, as they raced out over the Pacific Ocean. Following one such test launch, Lieutenant Jacobs was unexpectedly told to report to the office of Major Florenz Mansmann, a photographic analyst assigned to Vandenberg's Office of the Chief Scientist First Strategic Aerospace Division. Upon arriving he noticed two men in gray suits, who he later learned were CIA officers. A motion picture projector had been set up, and without explanation Major Mansmann turned it on, telling Jacobs, watch this. Jacobs, later a university professor, describes what happened next.

Lieutenant Robert Jacobs, Officer in Charge of Photo Instrumentation: On the screen was the film we had shot. The nose cones separate. The chaff flew out in front of it. We saw this as obviously reflections of light and rippling like that. And then we saw the dummy warhead flying along. It's going between 6,000 and 8,000 miles an hour at that point. And it's on the fringe of space. And suddenly, into that frame, an object flew in chasing the chaff, the warhead, and so on, at the same speed. After it had caught up and was in polar orbit, it fired a beam of light at the warhead. The beam of light struck it. The object flew up and shot another beam of light at the dummy warhead, went around, shot another beam of light at it, went down, shot a beam of light and then flew out the same way it had come in. At which time the dummy warhead fell out of the frame. The lights came on, and Major Mansmann said to me, 'Were you guys screwing around up there?' And I said, 'No sir.' And he said, 'What was that?' And I said, 'It looks like we got a UFO.' And he said, 'Lieutenant Jacobs, you are never to speak of this again. It never happened.'"

Decades later, Dr. Mansmann, by then a researcher at Stanford University, informed Dr. Jacobs that after he had left the room the two CIA officers quickly confiscated the film of the amazing incident, telling Mansmann that it was classified top secret. Mansmann also confirmed, in

31 July - 75 objects
 1 Aug - 29 objects
 2 Aug - 44 objects
 Totals 148 objects

F. E. Warren Air Force Base declassified report image 1.

ects - observed by 46 personnel
 ects 143
 Reported objects are mostly round,
 of oval/cigar-shaped and pencil-shaped,
 reported sizes vary from that of a pinhe
 naked eye, and from the size of a pea
 ough binoculars. Where sightings involv
 ed, echelon, cross, box and tail-shaped
 n August 1st, there was one daytime rep

F. E. Warren Air Force Base declassified report image 2.



F. E. Warren Air Force Base declassified report image 3.



F. E. Warren Air Force Base declassified report image 4.



Jay Earnshaw



Illustration of witnessed event.

letters to various researchers, that before the film was whisked away, he had conducted an extensive frame by frame analysis of it using a magnifier, which revealed the UFO in great detail. He wrote, “The disk shape was a classic disk. The center seemed to be a raised bubble. The entire lower saucer shape was glowing and seemed to be rotating slowly. At the point of beam release, the object turned like it was required to be in a position to fire from a platform. The assumption was, at that time extraterrestrial.”

Responding to the retired Major’s revelations, Dr. Jacobs wrote, “Those beams of light were a warning, a shot fired across the bow of our nuclear silliness ship.”

Then on August 1, 1965, a dramatic, large-scale UFO incursion took place at F. E. Warren Air Force Base in Wyoming, as this declassified report confirms. Dozens of sightings of disk-shaped craft cavorting at low altitude over Minuteman missile silos, known a launch facilities, were reported by the Air Force security personnel guarding them.



The Minot Daily News.

Former launch officer Jay Earnshaw has discussed his involvement in one such incident that night.

Former USAF Capt. Jay Earnshaw, F. E. Warren AFB, Wyoming 1965: I was in command of capsule Echo 1 at Warren Air Force Base. I got a call about 3:30 in the morning, somewhere in that time, from the flight security controller above, who said, ‘Sir, there’s some strange objects out there.’ I said, ‘What do you mean?’

And it turns out that he had observed, along with the rest of his response team members, what looked like five to six oblong lights stacked on top of one another, just outside the gate at Echo 1. They didn’t seem to cause any particular damage. They didn’t seem to put out any beams of light, or anything else like that. They simply were there, stacked up. It was rather a benign incident at the time. The paperwork all disappeared.



Major Gaylan King



Former USAF Captain David Schindele

Over the next two years similar UFO incursions also took place at Minot Air Force Base, North Dakota, and Ellsworth Air Force Base, South Dakota. Although those disturbing incidents were reported in official records at the time and occasionally leaked to the media, many of the details only emerged decades later in the testimony of former missile launch officers.

Major Gaylan King (USAF ret.), Ellsworth AFB, South Dakota, 1966: I was on duty at Echo which is our squadron command post. We had strike teams respond to alarms from the missiles. They were three to five miles away. And they jumped in their trucks and went roaring out there. And called me back and said, for lack of a better description, there’s a flying saucer hovering over that missile. And there’s a beam



David Schindele

of reddish light going down to it. I assume they were taking data with that beam. It wasn't destructive as far as I know. It had to be a data collection thing. I'm sure they scanned the warhead."

Although the Air Force could not yet know it, the most dramatic nuclear weapons-related UFO incidents were about to occur.

Former USAF Capt. David Schindele, Minot AFB, North Dakota, 1966: During the pre-departure crew briefing it was mentioned that some November Flight missiles had gone off alert. We reached the launch control facility. We entered the gate after giving the appropriate password, and the above ground personnel briefed us on what had happened. Essentially, we were told by the site manager that an object had been sighted out the windows, with flashing lights and was probably about 80 to 100 feet in diameter. It then went to the main gate where it hovered. And when we debriefed the underground launch crew, they indicated that all the missiles that they controlled had gone off on alert at the time the object had been hovering next to the main gate. My crew commander, Major Tolrud, told me that he had received a call overnight, while I was on rest break below ground, and saying that we as a crew were never to speak about this again. This was a very serious incident. I mean, something to take our nuclear tipped missiles off alert—it was something that we had never been prepared for.

The same year that these amazing events were in secrecy, Secretary of the Air Force Harold Brown appeared before a congressional hearing and

dismissed the idea that information about UFOs was being kept from the American public.

Secretary of the Air Force Harold Brown: We have not been hiding anything. The investigations have been made public. The explanations of those, where there is a clear explanation, have been made public. The hearing this morning was public just for that reason.

Brown's claims have now been discredited. But the strict security measures imposed on military witnesses at the time meant that decades would pass before the public learned about UFO activity at nuclear missile sites. In any case, the next known incident at Malmstrom Air Force Base, Montana, in March 1967, left no doubt that those aboard the UFOs were intent on disrupting the functionality of American ICBMs in their underground silos. On March 16, at Echo Flight, a missile security guard reported that a large round object had suddenly appeared in the sky and was hovering at low altitude directly over one of the missile silos. Moments later the entire group of 10 ICBMs mysteriously malfunctioned. This startling fact has been confirmed by one of the launch officers on alert that day, now retired Colonel Walter Figel, who spoke about the incident during a taped telephone conversation with Robert Hastings in 2008.

Figel said that in response to the missile guard's UFO report he had sent out two security alert teams, one of which confirmed the presence of the object.

Figel: "The strike team went out, one of the two claimed that they saw something over the site."



Henry Barlow

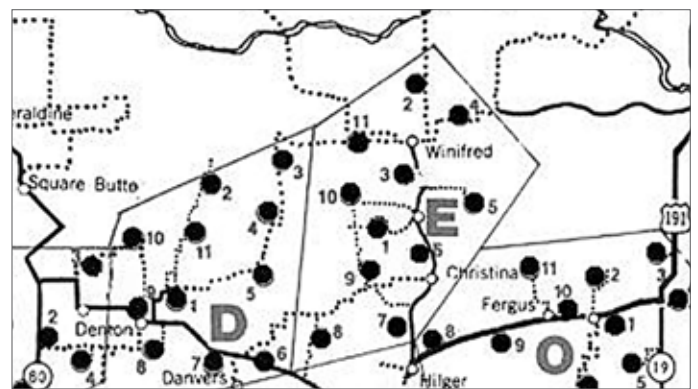

Map of Echo Flight, Malmstrom Air Force Base, Montana.



Robert Kaminski

Hastings: How did they describe that?

Figel: He just said a large round object.

Hastings: Directly over the Launch Facility?

Figel: Directly over the site.

But Figel was not the only one to be told that a UFO was in the vicinity during the incident.

Former Minuteman electromechanical technician Henry Barlow, who helped restart some of the stricken missiles, was informed that the mysterious aerial craft had actually caused the problem.

Henry Barlow: Job control called and said we have a problem at Echo Flight. And four or five missiles, or six missiles, just shut down simultaneously. And we want you to go to the nearest site, penetrate the site and see what's going on. So on our way to the site they had called and said the other four missiles had shut down, so that all of them are now shut down. At that time they saw UFO activity in the area. We had heard this on and off many times when we were out at the missile sites, that job control would call and say, we have reports of UFO activity in your area. Keep your eyes open. And I think we covered three or four sites. And they were sending other teams out from the base. We had to go to Echo 1 to stay for the night and get eight hours sleep before we headed back to the base. So when we got in there was hardly room to walk in there because there was so much brass. And we heard that a UFO was spotted over Echo 2, which is the most northern site in the Echo Flight.

In 1997 missile engineer Robert Kaminski, who headed the Boeing company tasked with



Captain Robert Salas

investigating the missile shutdown incident at Echo Flight, wrote to researcher Jim Klotz saying that no prosaic cause for the failures could be found. Importantly, the retired engineer also said that he had been informed that a UFO was responsible for the missile malfunctions. But the excitement was not yet over.

A second ICBM shutdown incident occurred eight days later, on March 24, 1967, at Oscar Flight, according to former Minuteman missile launch officer Captain Robert Salas, who was on alert when it occurred. This was the event discussed by Salas at the September 2010 press conference in Washington DC. Salas' testimony has been confirmed by former Minuteman missile targeting officer Captain Robert Jamieson, who helped retarget some of the Oscar Flight ICBMs.

Captain Robert Jamieson: In March of 1967 I was on alert for dispatch, and that evening I got a call from job control saying a missile had gone down in Oscar Flight. Go out and restart it. So I had called my team together. We went down to the hangar. I was told that a UFO caused all 10 missiles in Oscar Flight to go down.

Although this ominous situation undoubtedly concerned those in the know at the Pentagon, the chief of Project Blue Book, Major Hector



Reuter news article dated July 17, 1974.

Quintanilla, nevertheless presented a brave face when he spoke with reporters in response to a public uproar over nationwide UFO sightings.

Major Hector Quintanilla: After almost 20 years, and after having investigated over 9,000 cases the Air Force has, the UFO phenomena does not present a threat to the national security of the United States. [CAM: He can say this if he knew that we were closely working with the Eben.]

These same claims were made when the Air Force announced the closure of Blue Book in December 1969, at which time it again emphasized that no evidence existed to indicate that UFOs posed a threat to the country's security.

While many Americans may have believed this to be true, in reality the UFOs continued to monitor our nuclear weapons program.

As this Reuters news agency article confirms, in August 1973 one of the mysterious craft, dubbed a "ghost ship" was tracked on radar, maneuvering near a dummy nuclear warhead in flight as it raced toward a splash down in the Pacific Ocean near Kwajalein Atoll. This story cited information from unnamed scientists working for the US Army's ballistic missile program. This intriguing report suggests that the earlier Big Sur incident, as revealed by former US Air Force Lieutenant Robert Jacobs and retired Major Florenz Mansmann, was not unique. Although this weapons test a decade later was apparently successful, it's clear that UFOs have maneuvered near our dummy nuclear warheads in flight, on more than one occasion.

In the years that followed, other UFO incidents continued to occur at various nukes related



UFOs at defense sites told in CIA documents.

locations throughout the US. According to declassified documents, two B-52 bomber bases, Loring Air Force Base in Maine and Wordsmith Air Force Base in Michigan, were targeted by unknown aerial craft in late October 1975. Although initial reports referred to unidentified helicopters, one witness at Loring, Sergeant Steven Echner, later wrote that he had observed, "an elongated football, as long as four cars, reddish orange in color, briefly hovering near the nuclear weapons storage area. The object then zoomed away.

One week later, back at Malmstrom Air Force Base, as many as seven UFOs were sighted and tracked on radar as they intermittently maneuvered near, and hovered above, at various Minuteman missile sites over a several-hour period. According to numerous North American Aerospace Defense Command log entries released via the Freedom of Information Act, The UFOs were also unsuccessfully pursued by F-106 jet fighters before leaving the vicinity. One of the craft was apparently close enough to the ground to be described by security forces as an "orange white disk object."

At the Pentagon the National Military Command Center was so alarmed by the UFO incursions at Strategic Air Command bomb and missile bases that a security option three order was issued, placing the entire nuclear weapons force on high alert. Despite official efforts to suppress the facts, all of this eventually became known as military and intelligence agency files were involuntarily released to the public via the Freedom of Information Act.

If all of this were not enough, the next major UFO event really rocked the Pentagon. In late 1980, at the RAF Bentwaters Base in Suffolk, England,



Lieutenant Colonel Charles Halt

then leased by the US Air Force, a series of bizarre incidents left no doubt that something very strange was taking place. In the early hours of December 26, a small group of security policemen noticed an unusual light in nearby Rendlesham Forest. They approached it on foot only to discover a strange, triangular-shaped craft. After an indeterminate period of time, the unknown object silently raced skyward and disappeared.

Two nights later, RAF Bentwaters deputy base commander, Lieutenant Colonel Charles Halt, was informed that another mysterious light had suddenly appeared in the forest. Halt quickly assembled a small team of security policemen to investigate. After some time, the men observed an object that looked like a large eyeball moving through the trees. At one point material resembling molten metal was seen dripping from it. Suddenly the object split into five smaller disk-shaped craft, which silently scattered in all directions. A short time later another disk raced toward Colonel Halt and his team, abruptly stopped above them, and directed a laser-like beam toward the ground very near their feet. After a few seconds the beam clicked off, and the craft rapidly receded into the sky, moving in the direction of the RAF Bentwaters weapons storage area, which at the time was the largest American tactical nuclear bomb depot in Europe. As this was occurring, Colonel Halt began hearing excited radio chatter from security guards at the weapons facility



Radar target line illustration.



Control tower illustration.

indicating that the UFO was sending down laser-like beams into or near the storage bunker complex.

In 2007 Robert Hastings located and interviewed the two retired Air Force air traffic controllers who had been on duty at the Bentwaters tower that week.

Ike Barker and Jim Carey divulged for the first time they had actually tracked the crafts on radar the night that Colonel Halt was in the woods.

Jim Carey: I was sitting there, and I happened to see a dot come on the scope. And it just went like one dot at the beginning. Then another dot and another dot and it was gone. The scope was 120 miles across. It was just phenomenal for me to see it go that fast. All of a sudden here it came back across again. It went one, two, and then it made an immediate right hand turn and came right toward the base. You know, I just said, ‘That can’t be one of ours. No jet at that speed can make an immediate right hand turn.’ Just absolutely phenomenal.”

Ike Barker: “It’s not like any radar target I’ve ever seen. When the sweep would hit the target, the entire back of it would be like a solid line. Traveling an extremely high rate of speed, it passed over the

Я. старший помощник начальника связи в/части 52035 по АСУ и КАЦМАН Михаил Давидович, докладывая, что 04.10.88 года в 21.3 информациию табло аппаратуры 153343 произошло самовольно загорание всех транспарантов: РР, П, В, СТ, ДР, ГП, Д, СР, ПР, ПЦ, Г, СЦ, БТ, НБТ, ГП донесение, ГБ донесение, ПП, ПС, СР, ПНС, Э, ПЦС, ПЦНС розовых индикаторов как в режиме "засветка индикаторов" при п наватии. При этом на ленте АРИ также самопроизвольные зафиксированы информации:

- 4 пробела;
- контрольная кривограмма в 21.38;
- ЦП со звеном I с содержанием: "донесение ПП" в 2 Тестовый-контроль аппаратуры и зазор параметров согласно те гичаских карт: I-30 отклонения не выявили. Аппаратура функции нормальна.

Предполагаю, что произошедший олучай мог происходить

Soviet Union incident image 1.

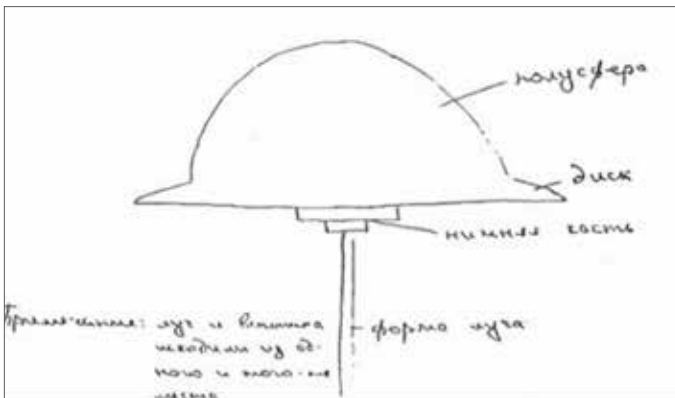

Soviet Union incident image 2.

control tower, and then it stopped. I've never seen anything in my life like the maneuverability that happened with this object. It sort of popped into my mind at that time that somebody is flying a basketball out here. There was like light around the center of it. But it wasn't like running lights or navigational lights. It was more like portholes, and then you were seeing the light from the inside coming out. It wasn't flashing lights or anything. It hovered momentarily, reversed its course, and went back out at a high rate of speed."

Moreover, given the dramatic incident at the weapons storage area, when one of those UFOs directed laser-like beams down into the facility, it becomes clear that this case had a nuclear weapons connection.

Significantly, another nukes-related incident in the former Soviet Union is nearly identical to Bentwaters. Government documents obtained by Western journalists after the collapse of the Soviet Union confirmed numerous cases of UFO activity in that country during the Cold War era, including one

картина наблюдалась приблизительно до 00:2³⁰ после чего она стала медленно угасать до полного исчезновения. Около 02⁵⁰ над тем местом, где висела светящаяся точка, появилась бледно-розовое облако в форме чаши, по цвету напоминающее зарево:

Soviet Union incident image 3.

at the Kapustin Yar military complex. On the night of July 28, 1989, a disk-shaped object with a dome was observed by dozens of Soviet army personnel as it briefly hovered over the base's nuclear missile warhead depot. According to one KGB report, as the stunned witnesses watched, the UFO directed laser-like beams onto the roof of a building in which those weapons were kept before silently racing away.

Another incident in the Soviet Union seven years earlier was even more shocking. On October 4, 1982, a huge flying disk apparently activated several nuclear missiles. According to Soviet Ministry of Defense documents secured by American television investigating reporter George Knapp, the UFO appeared over an intermediate range missile base near the Ukrainian town of Bilo Korovisch. At one point, down in the underground launch control



Captain David H. Schuur



Inhibit switch

capsule, several missiles suddenly went into count-down mode. Although no one had input the authorization codes, the missiles were preparing to launch. Then after 15 terrifying seconds the anomaly ceased, and everything returned to normal operational status.

This potentially disastrous incident was nearly identical to one reported to Robert Hastings by former US Air Force launch officer David Schuur, who said that a UFO had activated the launch sequence in several of his Minuteman missiles at Minot Air Force Base, North Dakota, one night in 1966.

David Schuur: As this object passed over the missile site we would start getting erratic indications on that missile. The bad thing was we also got a launch indicator.

Robert Hastings: Does that mean that the launch sequence has been triggered?

David Schuur: That means that the missile has received a launch signal.

In that case Schuur and his commander had to flip an inhibit switch to disrupt the unauthorized countdown.

But were those aboard the UFOs actually trying to start a nuclear war?

Robert Hastings: Having investigated these incidents for decades my opinion is that those who pilot the UFOs are visitors from elsewhere who are engaged in these provocative actions at American and Russian nuclear missile sites to send us a



Report on October 23, 2010, UFO incident.

message that we humans are playing with fire, that to engage in nuclear warfare is essentially suicide.

Importantly, these dramatic incidents continued to occur long after the end of the Cold War. Several US Air Force veterans have reported new UFO incursions at nuclear missile sites and weapons storage areas in the very recent past. The most important case occurred on October 23, 2010.

Wolf Blitzer: “This is CNN, breaking news. The breaking news involves a power failure that shut down a major part of the US nuclear missile arsenal. Let’s go to our Pentagon correspondent Chris Lawrence, What do we know?”

Chris Lawrence: Well, Wolf, this happened out in Warren Air Force Base, out in Wyoming. And bottom line is this. For less than an hour on Saturday, the base lost primary communication with about 50 intercontinental ballistic missiles.

Although widespread media coverage of the incident contained no hint of any UFO reports, a



Wolf Blitzer, CNN



F. E. Warren Air Force Base diagram.

subsequent investigation yielded intriguing information about a series of still unexplained sightings occurring during the communications disruption. According to confidential Air Force sources known to Robert Hastings, various missile maintenance teams responding to the problem reported observing a huge cigar shaped object maneuvering in the sky above the missile field. These persons state emphatically that the craft was not a blimp, because no passenger gondola, propellers, or stabilizing tail fins were visible, and there was no corporate logo or other advertising on its hull. The anomalous nature of the object was all but confirmed when these teams returned to base. According to Hastings' sources, the entire missile maintenance was sternly admonished by its commander not to talk to journalists or researchers, about "the things they may or may not have seen in the sky." Despite these revelations the Air Force officially maintains that the massive communications disruption was caused by an improperly replaced circuit card following repairs on a weapons system processor. Nevertheless, key personnel who were in a position to know the facts have described multiple independent UFO reports during the incident, which were allegedly suppressed by command-level officers.

These cases now number in the hundreds. People everywhere have a right to know the facts.

CAM: The United States Air Force has lied in the past and continues to lie in the present. They are the ones in control of all the secrets. They have every reason to continue to lie into the future. Wouldn't you if you had your own fleet of interstellar space ships. Remember what Ben Rich said. Again he said the following:

"We already have the means to travel among the stars, but these technologies are locked up in black projects and it would take an act of GOD to ever get them out to benefit humanity."

(Source: Statement made after UCLA presentation to three Disclosure Project witnesses.)

"Jim, we have things out in the desert that are fifty (50) years beyond what you could possibly comprehend. If you have seen it on Star Wars or Star Trek, we've been there, done that, or decided it was not worth the effort."

(Source: Direct comments by Ben Rich to Jim Goodall via telephone call at the USC medical center approximately one week before Ben passed away on January 5, 1995.)

CAM: For a while the freedom of information act was loose, and researchers were able to obtain a lot of information. Later it was tightened up to the extent that whole documents rarely ever come out anymore. There are now lawyers who specialize in FOIA requests because of how hard it is to get information.

The powers that be who are hiding these events and keeping them secret know that they will soon be out of the public consciousness. Due to our short attention spans they are soon forgotten. Repeated reminders are necessary to prevent these historical events from being lost to obscurity.

This page has no content.

Binary Code Incident:

RAF, Woodbridge, Rendlesham Forest, England



James Penniston

The Rendlesham Forest Encounter is the world's best documented UFO incident. It happened in the United Kingdom in 1980. A landed craft was seen and touched by Jim Penniston. During contact with the vessel, a binary code message was downloaded into his mind.

BRIEF OVERVIEW

The first documented binary code message was transferred by a landed UFO to James Penniston in Rendlesham Forest on the December 26, 1980. The second binary code message transfer occurred in Wadley, Georgia, in 2015 (summarized in the next chapter). Each of these incidents has crossover support for the veracity of their claims.

What follows is a summary and collection of quotes from the book *Encounter in Rendlesham Forest* by Nick Pope (New York: St. Martin's Griffin, 2015).

In 1980 Penniston was assigned to the largest tactical fighter wing in the US Air Force stationed at RAF Woodbridge in England. He was the senior security officer in charge of base security. At that time he held a top-secret US and NATO security clearance and was responsible for the protection of war-making resources for that base.

On December 26, 1980, a security patrol at RAF Woodbridge saw lights descend into Rendlesham Forest. James Penniston and others investigated and saw a craft. During this encounter, Penniston plucked up the courage to touch the landed ship. It felt hard and smooth and had symbols on it. This, combined with the close-up view of the hull, made him think of smooth, opaque black glass. He then moved to touch the symbols.

Upon placing his palm on the largest symbol, he received the download. After the download was complete the craft lifted off the ground. In his logbook he wrote: "Speed—impossible." More than eighty Air Force personnel, all trained observers assigned to the Eighty-First Security Police Squadron, witnessed the takeoff.

In Penniston's mind the ones and zeros were not letting him go. They kept flashing. Later back in his room, he started writing down the ones and zeros, and noticed that he felt better. He continued until he was finished and felt released. He decided that he had no interest in revealing the message. He considered it a great risk to his career. It wasn't until years later, when he was asked to retrieve his notes for some research, that the ones and zeros were brought to light.

Although not revealed to the public until 2010, at the time of the event Jim Penniston got the

impression that the ship was of human origin from the future—that they came to see us from the "year 8100" and were "exploring humanity for planetary advance."

MORE DETAILS

Direct quotes are from Encounter in Rendlesham Forest, pp. 228–244.

Over the years, as bits and pieces of the Rendlesham story came to light, Jim Penniston kept one staggering aspect of his encounter secret. Out of all the witnesses who saw the UFO over three nights, he came the closest to it. Indeed, he touched it. The secret he kept to himself, for over thirty years, is that when he touched it something extraordinary happened. Essentially, Penniston said that when he touched a particular symbol he received a sort of "telepathic download" of ones and zeros, which he now believes was a binary code message.

Jim Penniston: "As I move along the left side of the craft, I see what appears to be symbols of some kind, which were coming into view, as I move closer, my heart is beating as if it would jump out of my chest, as I write down what I am observing. I am shaking, it is beyond control, and I cannot stop this shaking. I stretch my hand out and close it into a fist, trying to regain steadiness. It seemed to help a little. As I look down the side of the craft, I see the inscription, is like nothing I have ever seen before, no aircraft marking, or no writing that I can identify. I am in an immense feeling of being overwhelmed, stacked with a feeling

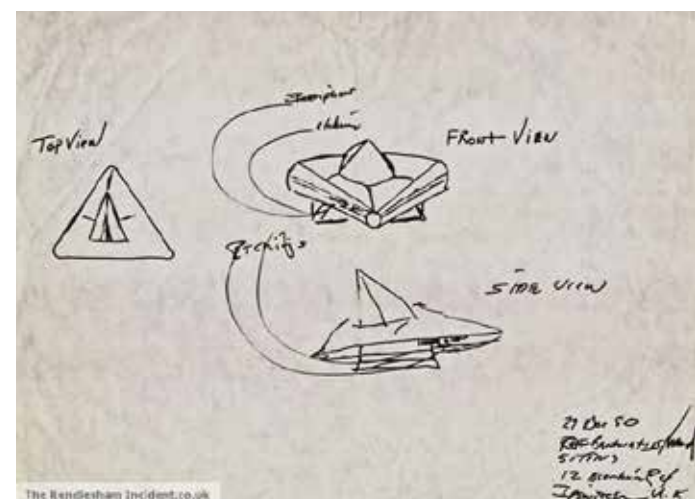

Jim Penniston's sketch of the ship.



Jim Penniston's sketches of the glyphs on the side of the ship.

of total disbelief. After quickly drawing the glyphs down in my notebook, I was ready for a second go-around of this craft-of-unknown-origin, so I put my notebook back in pocket and initiated the second walk around on the 360, more concentrating on the detail of the craft, and the fact it seems to be defying gravity by the absence of observation of landing gear, or at least landing gear as I have known it to be. As I walked down the right side of the craft, I realized that I was still intact, and not harmed. I was making small moves of assessment, noting that no sign of threat or aggression was apparent to this point. I figured if I was to die, it would have happened by this point. A small feeling of relief enveloped me. So I decided to take it a step further, I decided to touch the outer skin of the craft. Or maybe I was compelled to do that, it was never clear to me. As I ever so slowly walked or shuffled, I took my hand and touched the craft momentarily, then I started to shuffle along while taking my hands and running them along the side of the craft. One hand over the other, as I moved around it. After almost a complete circle I come back to the symbols or glyphs if you will. Running my left hand from the smooth fabric to a coarse sandpaper feel of the glyphs, slowly feeling and tracing with my hand these pictorials. I run the bottom glyphs which

measured about three feet long and a hand print high in height. Was the first one touched, then I traced my finger tips on and then on to the next . . . then on to the last one in the line of glyphs, I moved my fingers over this one. Then above the hand wide height of these glyphs that ran along for about two feet or so, was a much larger one, one that was more intriguing, and one which seemed to take on more importance than the others did. It measured I will estimate a couple of hands high and about three hands wide. It was a large etched or embedded circle, with a large triangle running from top to bottom. With two smaller circles, one at the top of the triangle and one slightly larger one on the bottom right of the triangle.

"I left not touching the large one, till last, it seemed like this was by design. I was curious but I felt that this was the key to the craft. I took my fingers and ran them slowly around the outer circle of the craft. I then took my fingers off, and hesitated while making a closed hand, and then I opened my hand and flatly pressed the palm of my hand on the large triangle. What was to happen next, defies reality. For I was no longer to see, what I was seeing in what I will call the mind's eye. Was bright and steady brilliant light, I was squinting? Then the stream of ones and zeros ran relentlessly and I was unable to see my surroundings, I was scared, though I seemed to understand it was not harmful, but required. I am not sure how long this took place, this bright light with flashing of these ones and zeros. Seconds, or minutes, it seemed like a brief moment. Unable to pull my hand back, I finally had it release my hand. As quickly as the release of my hand from the triangle, the ones and zeros stopped. Thank God, I thought, I quickly started looking at my hand, I was examining it for damage. Seeing none, I was not going to do that again. No need to have physical contact again with the craft. Scary and unreal it all was.

"I started to see the craft generating color through the fabric of the craft again. It started to become bright again, and began moving through the trees and then hovered at the top of the trees and with a flash and a blink of eye it was gone.

"I hear movement to my right; it's John. I am wondering where he had come from and where was he during this encounter. My thoughts are broken with John quickly pointing to a direction out in the

farmer's field. "There it is, Jim, let's go!" As quickly as he said that, he was off and I was right behind him.

"So what happened with those flashes? Well, years later, I find that they are not just ones and zeros; I always had a thought or feeling that they meant something, but never acted on it. It is like all was supposed to wait. Like everything had its own time line. Or it could be something simpler, like a part of the condition of Post-Traumatic Stress Disorder (PTSD). Time kept travelling on, and then more than a decade passes and finally some answers about those ones and zeros. Apparently the binary codes were a direct result of contact with a physical craft, a craft of unknown origin. Meaning it was an unidentified craft and where it came from is still unknown.

"The next day, while looking at my notebook . . . the glyphs in particular, I have had the codes running through my head since the incident the day before. I had a feeling to write them down . . . for I did and immediately after finishing them the codes were gone from my mind. I was finally at rest with them. The notebook was then put away and retired to a box. For a new one for work I had available. My thoughts at the time, although profound, were actually much simpler. I wanted it to go away, and I had no need to talk about it either. For this was not to be the case."

Nick Pope: "The UFO [Penniston] saw was seen by others, including the Deputy Base Commander. It was tracked on radar and left physical traces such as damage to the trees and—most tellingly—radiation levels that were assessed by the MoD as being significantly higher than background levels. Moreover, Penniston is hardly your average witness. At the time of the encounter he was a staff sergeant who was the on-duty flight chief at one of the most sensitive military installations in NATO. Because of the nature of his responsibilities, he had been formally evaluated and judged to be fully compliant with the USAF's PRP. . . .

"I think it is abundantly clear from what follows that Penniston is still traumatized by these events to this day. His direct and frank writing style marks him out as somebody who shoots from the hip and I have not sought to tone this down:"

Jim Penniston: "The binary code or should I call it the binary enigma? To tell you where it is now at, I think we must go back and look at how the exchange of ones and zero happen in the first place.

"On night one or the 26th of December 1980 is where it had all started and I could not have foreseen what the impact for me on this would be. The binary codes were a direct result of my unexpected and humbling contact with a physical craft, during the first night. As I investigated the remarkable event, I was seeing things that were unexplainable at the time and for that matter are unexplainable today. The longer around the phenomena, the more confusing it all appeared. As each moment passed with a flow of unknowns that were unfolding before me. I was trying my best to evaluate what it was, and more importantly what it wasn't. I had asked myself: how could this be happening? I was trying to conceive a rational explanation, of what this could be. And I kept asking myself why was it sitting in front of me in this small clearing at a forest? As I observed, I knew that this technology was extremely advanced, far above any that I had seen to that time, and even to this day.

"Thus leaving the only way to report is to keep it strictly in military terms. My military assessment (one that would be acceptable in my reports), a craft of unknown origin, simply stating it was an unidentified craft and where it came from is still unknown today with a 100 percent certainty. The communication of binary codes (the term 'binary code' was unknown to me at the time and I did not make the connection until October 2010) was accomplished when I physically touched the craft's glyphs, which were located on the outside skin of the craft. It activated a technology which is unknown to me, and apparently to everyone else too. The technology then communicated a series of ones and zeros to me. The communication transfer was accomplished within minutes. There was an area of about fifteen feet which surrounded the outside of the craft. This area I will call the bubble. For within the bubble, static electricity pulsed upon my clothes, skin, and hair. Also an appearance of slowing of time. The air seemed dead, not transmitting any sound. An extraordinary and sensational event, for sure,

one that defied all I ever knew, or all I could ever imagine.

“The following day in the morning, at my then home in Ipswich, I finally had gotten up. After a very disrupted night of nightmares and very little sleep. During the night I was often waking with thoughts, or rather images, of visions of ones and zeros running through my mind, my mind’s eye. It was an overwhelming and scary experience for sure. I had thought it was something on the verge of madness. I was struggling and I tried to compose myself the next morning. The trauma of the night/day before was finally starting to begin setting in. As I sipped on my cup of coffee, I felt so alone. As I was at the dining room table, I was so perplexed by the happenings of the day before. Trying to make sense, but more so, hoping and wishing these numbers would leave my mind. Overwhelming at times, and annoying at best, the bigger worry was the fear I was somehow damaged or hurt from my contact with this thing. How can these ones and zeros seem to be imprinted in my mind like a hot branding iron? My only hope was they would dissipate as the hours and days would pass. Because there were no other options, for I was not going to the base hospital with this. If the incident was not a career ender, then reporting for medical treatment with a recount of ones and zeros keeping me awake and overwhelming my thoughts was surely not the way to go, and this I truly felt would be the end of my air force career.

“As I sat there, and picked up things that would later become evidence of that night, I relooked at the pod casts that I had made shortly after the encounter by us some 24 hours earlier. As I sat there in somewhat disbelief I slowly ran my fingers over the landing pod cast, still somewhat damp from being poured shortly after the incident and the day before. Picking it up at times and smelling the mustiness of the plaster of Paris, its odor was with the distinct smell of the forest floor clearly on it.

“As I reflected, my mind wondered in thought of what it could have been that me, Burroughs, and Cabansag saw and pursued at different points on that Friday night. If that was not enough, I was also thinking of the flashes and the flashing of the blinding light, and the craziness of the ones and zeros which seemed to flash across my sight, but

only blind to all other things. And for God’s sake, why could I still see them? Laying down the pod, I then picked up my notebook that I carried that night from the side counter where I had emptied my pockets from the day before after coming home from working my last midshift. I sat back down and began to thumb through the pages; I patiently relooked at the glyphs that I had copied down. While I had begun to start looking through the notebook for the third and then for the fourth time.

“The glyphs in particular had my attention. As I did this, the ones and zeros started coming back to me, almost bothersome as they start up again; there I sat, having what had kept me up the night before to start again. I had the ones and zeros begin to start running through my head again. Not blinding as before, but flashing in what seemed a sequential fashion. I was so worried that this trauma and feeling I could never share, this madness, with no one. I was actually wondering if my sanity could survive this barrage. I was forever a prisoner of my own madness. Since the incident the day before, this was the new normal for me, so my thoughts were clearly were how was I going to survive this trauma that I have experienced? How could I even function with day-to-day life, not to mention curing myself from it? It was then that it happened, a momentary lapse of reason. A thought of writing those ‘ones and zeros’ down. The more I thought about it, the more I felt compelled and was at the fringes of obsession to copy what my mind’s eye was seeing. I had an even more overwhelming urge or, more precisely, I had a feeling of compulsion to write them down, this was now imperative and it had to be done immediately without further delay.

“Finally I started by copying on the only available paper that I immediately had in front of me. It was my notebook. So I randomly flipped back to some new pages and so it began. So hesitantly I slowly started to write down the numbers, for I thought that this was beginning in the memory of madness. I first wrote a zero and then a one, and another, as I began to write it all down one number after another, as I was seeing the flashes in my mind. I wrote them down on a steady pace. As it progressed. Slowly as this act of madness was continuing. I was feeling a little better, a little bit that is. The

small pieces of peace and fragments of satisfaction began. I started to write them down faster. I only had to stop a couple of times, because the pens I was using to record these ones and zeros kept stopping and apparently kept running out of ink. Each time that would happen I would momentary panic while seeking another pen from the drawer of the cabinet, looking for another pen. Finding one, I would then sit back down at the table, and began my quest, my mission again to write those ones and zeros down, through this episode of madness of writing them down; I was finally seeing greater relief. I wrote effortlessly, as fast as they would flash in my mind, I would transcribe them to paper.

“I did this continuously for about three-quarters of an hour or so. What began out of an act of desperation and madness ended as fast as it had begun. Upon finishing the writing of these numbers. What started so quickly just stopped. Seeing no longer any images of those ones and zeros in my mind. Immediately after not seeing them no more and stopping of writing them, it was then the flashing of the ones and zeros was gone in their entirety from my mind. For the first time since it began, some 24 or so hours earlier, I was finally at rest with them. An immense feeling of relief came over me. But something even worse stayed with my immediate thoughts. The thought of trauma and writing of these numbers like a madman. I asked myself: how can I tell anyone about this? The obsession to write down flashing numbers in my mind that were relentless since the encounter with glyphs on the craft. Who could I talk to? I surely could not go to the base clinic and complain about this? I would be looked at like a madman I was solidly convinced. After all I was certified under the Personnel Reliability Program (PRP), I was on the firearms issue and carry list. And of course I had my security clearance. I thought that everyone that I would tell about the incident, they would be obligated to report what I would say or had experienced. All the trappings of insanity were dripping all over it. Yep, most certainly it was a career-ender.” . . .

Jim Penniston, cont'd: “The choice was clear, since writing those ones and zeros down, I was relieved that my mind was now clear and free of those things.

Thoughts of what had tormented me from shortly after the incident and seemed to run unabated were actually gone. I was free, and more importantly I was relieved. The situation before was not a situation to deal with by myself. As the minutes went by, the clearer things had become. For what had happened here, it looked like I was going to be alright. I felt normalness for the first time since the incident. Never to mention the madness of the ones and zeros again to anyone, for they are now history and I am on my way to some normalness in my career. The ones and zeros are gone forever, or so I had thought, the madness of them would never be known. On the evening of the 28th of December 1980 just after supper I received a call from a Sergeant who worked in the Security Police orderly room. He told me that he received a call from the Squadron Commander to have me report to the AFOSI building in the morning. I told him I would comply. Funny thing is, he never asked any questions either.

“Over the next few weeks and months I was methodically and consistently interviewed and interrogated by people within my chain of command,

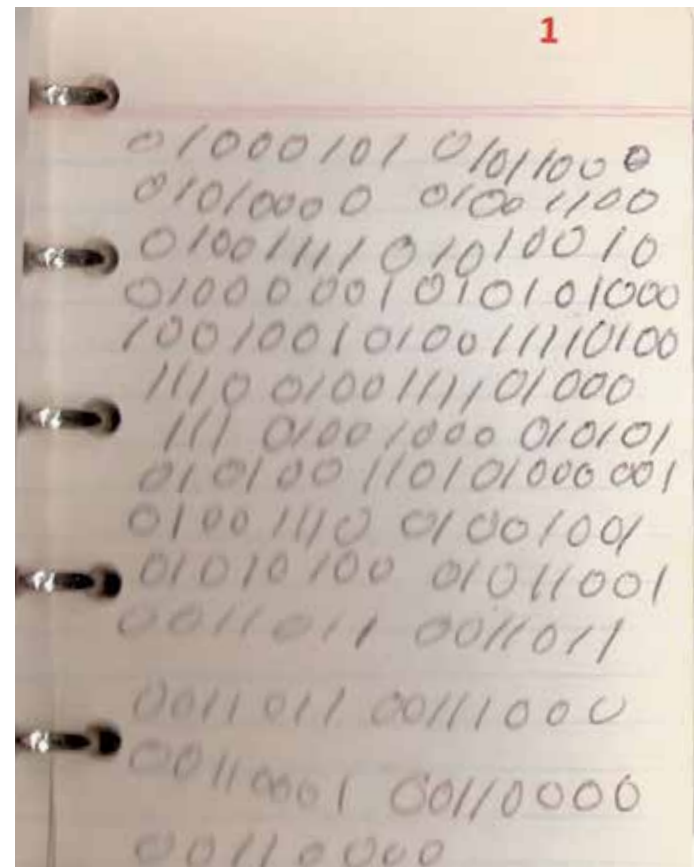

Page 1 of Jim Penniston's binary code notes.

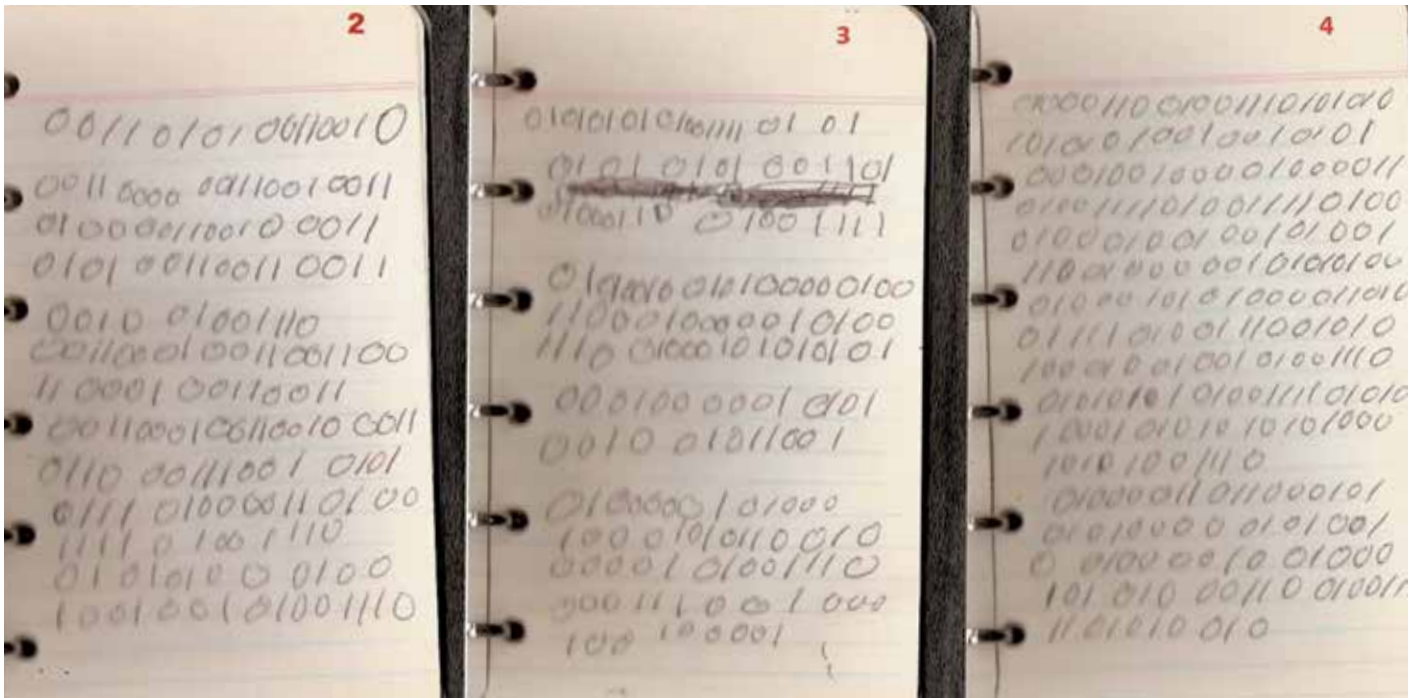

Pages 2, 3, and 4 of Jim Penniston's binary code notes.

other Air Force agencies and others who were of other branches of service and other departments of the United States. Sometimes remembering those discussions and interviews and sometime not remembering them for decades. Every time, I was promised that this was the last interview and it would be absorbed into the classified annals of data and I would need to tell or talk about it no more. This was not the case. I went through at least fourteen debriefings and two by non-air force personnel. And many that I would not remember until decades later. I gave all information from memory and at no time was the notebook ever brought up. The debriefs were always the last one and were all for the last time; for if it was not AFOSI, it was to be everyone in my chain of command and all that I would meet with an inquisitive question. At the AFOSI building I was told and was promised: tell all and tell it correctly with no omission and it would be the last of questions on Rendlesham. How untrue this would become, as the years passed. For these were to continue, no matter what I had said. For it was unknown to me at that time, or the other visits to AFOSI or wherever it would be, I would not have memory of them, well, at least until them being told in the hypnosis some fourteen years later.”

Nick Pope: “. . . The first time Penniston mentioned the codes was in 1994, shortly after he left the USAF. Suffering from health problems and sleep disorders, he had no belief that the sleep disorders were a result of anything other than stress. Penniston privately contacted a local hypnotherapist who could address the sleep disorders and the associated waking up throughout the night. It is important to say that she had nothing to do with the UFO community, nor did she even believe in the paranormal. After a few appointments it was agreed upon to do a regression hypnosis session and during the taped interviews (taped for the hypnotherapist's notes) it was discovered that a portion of time in Penniston's memory was blocked. She said, 'It was the first time I have ever encountered this, although I have read about it.' What came out of the regression astonished the hypnotherapist as well as Penniston. . . .”

Jim Penniston: “In 1991 medical issues with my inner ear are now diagnosed as Meniere Disease. In 1993 I retire from the USAF. In 1994 I have severe sleep issues and post-traumatic stress from the incident, and continuing problems from the now diagnosis of Meniere Disease. The Veterans Administration treated Meniere Disease. They would not afford post-traumatic stress treatment for the incident. They

said there was no evidence of anything happening at Bentwaters in 1980 which could produce this condition. So I had to seek private help for the sleep disorder and the post-traumatic stress. I also sought to remember, for I had memory voids of things from that time.

“Transcript extract of my second hypnosis session on September 10, 1994, I begin to break through an apparent post-hypnotic suggestion by the AFOSI hypnotizers to keep me from talking. The following are excerpts from that second session in which the American and British intelligence people seem to have anticipated before their sodium pentothal hypnosis that I received a telepathic download of binary numbers.”

Extract of Hypnosis Session, September 10, 1994

Hypnotherapist: *You weren't supposed to understand the program?*

Penniston: *No. By touching these things [the raised glyphs on the craft's surface] I activated these things.*

Hypnotherapist: *You touched the symbols and you set off a program?*

Penniston: *Yes. It was repairing itself. All they wanted was a place to stay while it repaired itself.*

Hypnotherapist: *And by touching the symbols, you disrupted the repair program?*

Penniston: *I activated a binary code. The two [government agent] men want to know why.*

Hypnotherapist: *And what do you answer them?*

Penniston: *They ask me if I ever had any other encounters with them [binary and them the time travelers]. I haven't. They are discussing it between themselves. The situation. They've got a problem.*

Hypnotherapist: *What's their problem?*

Penniston: *Their problem is because I can't tell anybody. They ask no more questions about the craft. And they want to know [discussing with each other] what to do with me.*

Nick Pope: “This is a fascinating development. While theories about time travel have previously cropped up in ufology, they are uncommon and not

popular. . . . If Penniston was confabulating (giving false information honestly, e.g., as a result of brain damage or a psychological disorder), one would expect him to come up with a story about extraterrestrials, not time travelers. But yet he was very clear on this, at one point stating, “They are time travelers—they are us.”

“Penniston clearly had his own doubts about the time travel theory and about the binary codes. Indeed, he is at pains to point out that he did not originally connect the ones and zeros with binary code.

“Once the possibility had been raised, Penniston shared a small part of the codes with some trusted individuals. These included Linda Moulton Howe, a filmmaker and journalist with a strong interest in UFOs; Kim Sheerin, co-executive producer on the popular History Channel TV show *Ancient Aliens*; Nick Ciske, a Web designer who is an expert in ASCII (a character encoder) and binary code; Joe Luciano, a computer systems engineer who had experience of binary codes while working in the USAF; and Gary Osborn, an author with an interest in a wide range of esoteric subjects.

“Kim Sheerin recalls it like this: ‘In October of 2010, our production team spent a day with John, Jim, and Linda in Phoenix interviewing each of them on the Bentwaters incident. In describing the events of December 26–28, 1980, Jim Penniston recounted the designs he saw on the craft-of-unknown-origin and described his experience of feeling compelled to write down ones and zeros shortly after touching the craft.’”

Jim Penniston: “It was around that time that there was a pause in shooting and John asked about a certain date and I said, ‘Yes, John, I have that written in my notebook here.’ So when I started to thumb through the notebook looking for the date he asked for, I started to flip the ones and zeros pages. I was stopped by the producer and got the immediate attention of John and Linda, asking what was that written in the notebook. Casually I tell them, ‘Oh, it is the ones and zeros from that night.’ Linda jumps up and said, ‘You wrote them down?’ and I said, hesitantly, ‘Yes.’ Everyone was excited with what I have felt for thirty years was a product of my temporary

madness from exposure to the craft that night. No one knew there at the film shoot that I was reluctant and also ashamed of what the ones and zeros meant to me that morning of the next day after the incident. It was a secret I kept only to myself until filming the shoot and until I made the slip about the ones and zeros. I told Linda and the rest of the film crew that I had written these down in my notebook. The original notebook I had from that night was in my hand. Well, everyone had pretty much stopped and got excited and was curious about what I had told them. Everyone present, including John, asked me, 'You recorded them?' and I said, 'Yes.' All eyes were on them at that point. Linda wanted some experts to see them. I agreed for her to do that . . . but unbeknown to her, I also gave copies of the codes to Kim Sheerin, for their expert to decipher."

CAM: All sixteen pages of the binary code in Jim Penniston's notebook were reproduced as Appendix B in *Encounter in Rendlesham Forest*. The following is the translation offered by Penniston, based on the work of the various experts listed in the book. It consists of brief snatches of text, together with numbers, interpreted as latitudes and longitudes, the locations of which are given in brackets:

EXPLORATION OF HUMANITY 666 8100

52.0942532N 13.131269W [Hy Brasil]

CONTINUOUS FOR PLANETARY ADVAN???

FOURTH COODINATE CONTINUOT UQS

CbPR BEFORE

26.763177N 89.117768W [Caracol, Belize]

34.800272N 111.843567W [Sedona, Arizona]

29.977836N 31.131649E [Great Pyramid in

Giza, Egypt]

14.701505S 75.167043W [Nazca Lines in Peru]

36.256845N 117.100632E [Tai Shan Qu, China]

*37.110195N 25.372281E [Portal at Temple of Apollo
in Naxos, Greece]*

EYES OF YOUR EYES

ORIGIN 52.0942532N 13.131269W [Hy Brasi]

ORIGIN YEAR 8100

Here are Penniston's final thoughts on the binary code and on the possibility that this is a message from the future. . . .

Jim Penniston: "So the above is the binary code decipher, or as I refer to it the binary enigma. As I have always said from the very beginning of my exposure and witnessing of the incident, it was clear that I could with 100 percent certainty tell you what the craft was not. The hard part is this: what exactly was it? It was not an airplane in the Jane's book of known aircraft, or many other things. What I cannot tell you is exactly what it was. It is just like this binary? How can it be possible to receive such information from contact that night? How could I go home and 24 hours later write these ones and zeros down from memory? How, why, and a thousand more questions I have. Under hypnosis, I reveal that they are time travelers from the future.

"I have a detailed tale of them while under this hypnosis in extreme detail. Then I have the real evidence: the written binary, the day after the event; the glyphs observed on the side of the craft; the pod casts that were made later on the morning after the event. Why does this translate in English and not some alien language that cannot be understood? Why did the aircraft have remotely terrestrial similarities?

"So how can it be that the physical evidence seems to back up the hypnosis? It is all good food for thought . . . Will we really have the answers to this enigma? My thoughts on this: a firm yes.

"During my investigation and in the course of my research with the time traveler evidence (as it kept coming up at various points when looking for the definitive answers to Rendlesham and the enigma), the answer to that question is that there are no definitive answers at this point in time. In recent years I find that Rendlesham is not the only incident which other military have evaluated as time travelers. I find that I am not the only one who has suggested this, by looking at the evidence of a particular case. The same thing happened with Project Avalon: they were talking about the Roswell visitors and

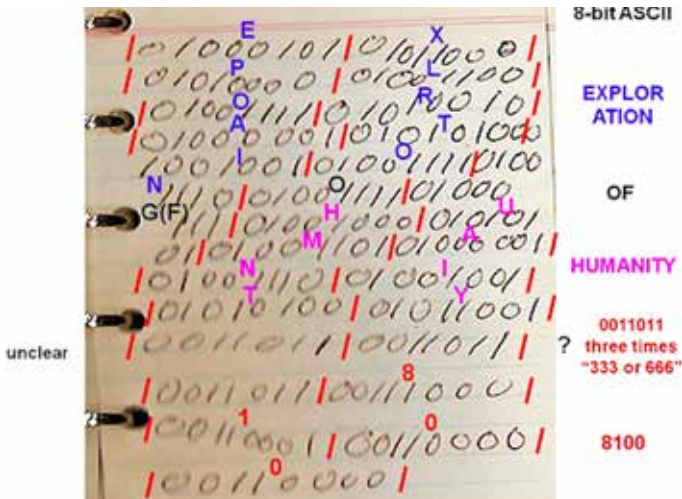

Page 1 of Jim Penniston's binary code notes, decoded.

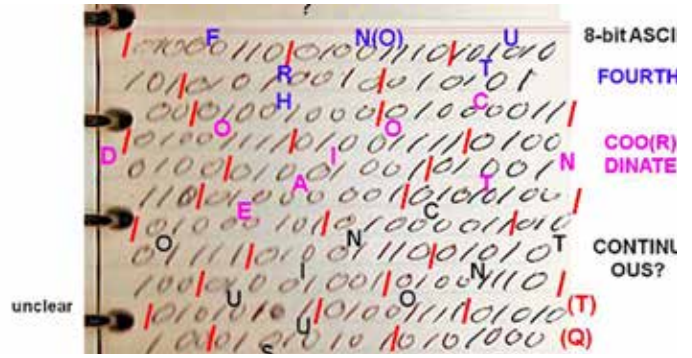

Page 4 of Jim Penniston's binary code notes, decoded.

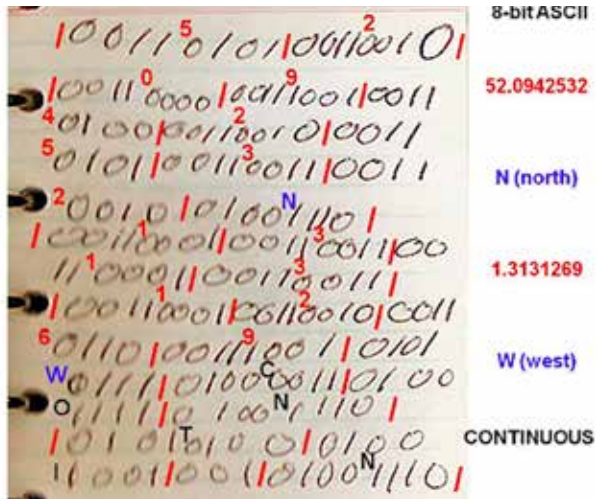

Page 2 of Jim Penniston's binary code notes, decoded.

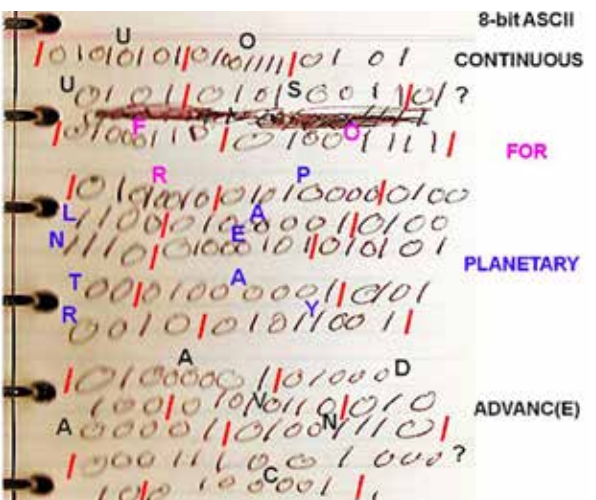

Page 3 of Jim Penniston's binary code notes, decoded.

A	■□■□ ■■□□	N	■□■□ □□□■
B	■□■□ ■■□■	O	■□■□ □□□□
C	■□■□ ■■□□	P	■□□□ ■■■■
D	■□■□ □□■□	Q	■□□□ ■■■□
E	■□■□ ■□□□	R	■□□□ ■■□■
F	■□■□ ■□□■	S	■□□□ ■■□□
G	■□■□ ■□□□	T	■□□□ □□■□
H	■□■□ □■■■	U	■□□□ ■□□□
I	■□■□ □■□□	V	■□□□ ■□□■
J	■□■□ □□■□	W	■□□□ ■□□□
K	■□■□ □■□□	X	■□□□ □■■■
L	■□■□ □□■□	Y	■□□□ □■□□
M	■□■□ □□□□	Z	■□□□ □■□■

Example of binary code alphabet.

Admiral George Hoover said that ‘these visitors were us from the future. They were time travelers; they weren’t extraterrestrials.’ Now other researchers and whistle-blowers have spoken about the same thing and this is fascinating in itself. But what Admiral George Hoover said ‘the biggest secret’ really was—it had to do with the abilities and the power of the consciousness of these travelers. Because they were us from the future, what the military authorities had found out was what humans are really capable of. This had been buttoned up really tight, because if we knew how powerful we really were, how powerful we really could be, then we would cause chaos around us, and this could never be permitted. We could rearrange the reality around us in the way that we wanted to, in the way that—if this is real—the future humans had learned how to do, which gives them

access to these sorts of incredible abilities, such as time traveling.

“I have my own beliefs, but in no way expect you to blindly go with my thoughts or my beliefs on this. If I were walking in your shoes, well, I would look at the evidence that has been presented in this book. I would then take a step back and then would look at all the evidence and systematically evaluate the evidence with the binary and draw my final conclusions myself. You must decide is this as Jim Penniston believes, that it is time travelers from our future came back in time to 1980, or is it something totally different than that? It is for you to decide. A question running through my thoughts is this: why did I decide for this binary message to be made public? After all, it could be conceived as a private message, for only me to know. But then I ask why would it be me? I am only one of many, so I think that the only answer that I can give is the most honest and simple. So my thinking is that it is for all of mankind and not one man. After all, if they are really us from the future, then this is a message for all of us, from us in the future, giving me this conclusion for myself about the binary: what if the whole point to the contact in December 1980 was for us to publish this binary message at this point in time? It is my thought, but if they are from the future the great part of that thought is that sometime in the future we will know if it is true or not. Is there more to come? Yes, I believe there is much more to come!”

Nick Pope: “. . . Here is what Penniston wrote about this in 2010, in an attempt to make sense of it all.”

Jim Penniston: “Any inconsistencies in my account can easily be attributed to the meddling of the inept debriefing and the drug-induced attempted extraction of information by the U.S. agents at the AFOSI building, or quite possibly by the phenomenon itself. The other factor is simply my state of mind at the time of the incident. I was shaken deep within every fiber of myself by all that I saw and experienced, in the midst of doing my job that night. It was more than unraveling and disturbing for me. It was ‘life-changing.’ This does not take into account my private ordeal at home with the binary

hell I was encountering, as well as other things immediately after the incident. I believe I was possibly a primary reason for Colonel Halt’s inconsistencies in his infamous sanitized memo as well and the initial confusion about many things with the incident. Of course, then causing more of the initial confusion was the blanket of silence directed by the base command; I also think this was also a major factor.”

Nick Pope: Anyone who was a witness or in the know about the incidents was silenced and the people who were talking were people who unknowingly perpetuated the cover story, some of them by proclaiming that they were witnesses to the events.

CAM: The encounter in Rendlesham Forest was covered up and sanitized by the U.S. Air Force. Now that the details have been shared and published, the evidence speaks for itself. This event needs to be taken seriously and not forgotten.

ANALYSIS OF THE COORDINATES DERIVED FROM THE BINARY CODES OF JIM PENNISTON

Updated 2014/4/23

All text © 2011-2014 by Joseph R. Luciano

All notebook images © 2011-2014 by James Penniston

[binarydecoder.info/RFI-BinaryCode/BinaryDecoder_Analysis_of_Geographic_Coordinates.html]

Introduction

Joseph Luciano: “The following is my analysis of the seven geographic coordinate pairs derived from my decoding of the 16 pages of binary codes in the notebook of Jim Penniston. He recorded these binary codes the day after his experience in the December 1980 Rendlesham Forest Incident in the UK while he was in charge of security at the then USAF joint bases RAF Bentwaters and RAF Woodbridge. These binary codes were decoded (translated) into alphanumeric characters using 8-bit ASCII by my Binary Decoder v3.1 program. . . .

“The raw coordinate data below is from my final decoded and interpreted (all ‘transmission errors’ resolved) data from the binary code.”

Original Coordinates as Decoded by Binary Decoder v3.1:

Coordinates from Pages 1-5 of Binary Codes:

520942532N13131269W

Coordinates from Pages 6-13 of Binary Codes:

16763177N89117768W

34800272N111843567W

29977836N31131649E

14701505S75167043W

36256845N117100632E

37110195N25372281E

Coordinates from Pages 14-16 of Binary Codes:

520942532N13131269W

(NOTE: An 8th coordinate pair that is simply a repeat of coordinate #1 from pages 1-5)

Background

Joseph Luciano: “The strings of 0 and 1 digits were originally provided to Jim Penniston during the 1980 Rendlesham Forest UFO Incident in binary form as binary digits (bits = 0 or 1), the ‘language’ of computers, from a ‘craft of unknown origin’ which was apparently un-piloted, and therefore very likely computer controlled. The binary code was translated using my Binary Decoder v3.1.

“By having the 8 sets of numbers, we can more readily see patterns which help us figure out how to parse them into something meaningful.

“Since each string of characters consists first of a string of digits followed by an ‘N’ or ‘S’, then more digits followed by an ‘E’ or ‘W’, we can easily conclude they are geographic latitude/longitude coordinate pairs specifying locations on the Earth.

“Latitude is expressed as 0-90 degrees N(orth) or S(outh), and longitude is 0-180 degrees E(ast) or W(est). Therefore latitude needs a maximum of 2 significant decimal digits (to the left of a decimal point) and longitude needs a maximum of 3 significant decimal digits (to the left of a decimal point).

“Also, latitude/longitude can be expressed in at least two common forms:

1. Degrees/Minutes/Seconds (DMS)—example:
52°09’42.532”N 131°31’26.9”W
2. Decimal—example: 52.0942532N 131.31269W”

Preliminary Analysis

Joseph Luciano: “Since there is no punctuation (decimal points, degrees/minutes/seconds symbols, or spaces) within the coordinate numbers from the binary code message, we need to figure out how they should be parsed (broken down) into valid latitude/longitude values. Since the binary codes came from an apparent computer source (‘craft of unknown origin’), and computers are, if nothing else, precisely consistent, all the number sets MUST be in a format that follows consistent rules. We, therefore, can surmise that the numbers, which are of variable length, must be in a fixed assumed decimal place format.

“With respect to numeric values and fixed assumed decimal place format, computers use a ‘right justification’ technique, lining them all up on the right side and inserting zeros (or spaces) on the left side were necessary to make all the numbers of fixed length with an assumed (invisible) decimal point in a predetermined position.”

Latitude Numbers

Joseph Luciano: “We note that the longest latitude number is the very first one (520942532N)—at 9 digits. Since latitude must be in the range 0–90 degrees, it could represent .5, 5, or 52 degrees. However, interpreting this number as .5 or 5 degrees would establish a fixed format that would cause all the remaining latitude numbers to be less than zero degrees, and I believe that to be highly unlikely.

“Therefore, we can deduce that the first 2 digits of this first coordinate represent a valid latitude of 52 degrees, thus leaving 7 digits after the degrees of latitude. Therefore defining that there are 7 least significant digits after an assumed decimal point. This same coordinate pair appears on pages 1–5 and again on pages 14–16.

“After applying this same logic to the latitudes in the 6 coordinate pairs appearing on pages 6–13, I determined that those had 6 decimal places. I can not readily explain why there is this difference in number of decimal places in the latitude numbers between the first coordinate and the other six. Maybe since the first coordinate pair on pages 1–5, which is repeated on pages 14–16, and is apparently identified as ‘ORIGIN’ on pages 14–16, needs to be more precise for some reason.”

Longitude Numbers

Joseph Luciano: “We note that the longest longitude number is the next to last (117100632E)—at 9 digits. Since longitude must be in the range of 0–180 degrees, it could represent .1, 1, 11, or 117 degrees. Interpreting this number as .1 or 1 degrees would establish a fixed format that would cause all the remaining longitude numbers to be significantly less than zero degrees, and I believe that to be highly unlikely.

“Therefore, we can deduce that this value is either 11 or 117 degrees making the first 2 or 3 digits represent a valid longitude of 11 or 117 degrees, thus leaving 7 or 6 digits after an assumed decimal point in the longitude. Therefore defining that there are 7 or 6 least significant digits after an assumed decimal point, which we will use to parse each longitude.”

Intermediate Analysis

Joseph Luciano: “So, only the longitude numbers are subject to different possibilities with either 6 or 7 least significant digits (after a decimal point), which gives us only 2 possible sets of interpreted coordinate pairs, one with 6 decimal places in the Longitude and one with 7.

“Separating out the degrees with a space (for now), and right-justifying them, the numbers now look like:

Possibilities A (7 decimal places in Longitude):

#1A:	52 0942532N	1 3131269W
#2A:	16 763177N	8 9117768W
#3A:	34 800272N	11 1843567W
#4A:	29 977836N	3 1131649E
#5A:	14 701505S	7 5167043W
#6A:	36 256845N	11 7100632E
#7A:	37 110195N	2 5372281E

-OR-

Possibilities B (6 decimal places in Longitude):

#1B:	52 0942532N	13 131269W
#2B:	16 763177N	89 117768W
#3B:	34 800272N	111 843567W
#4B:	29 977836N	31 131649E
#5B:	14 701505S	75 167043W
#6B:	36 256845N	117 100632E
#7B:	37 110195N	25 372281E ”

Joseph Luciano: “Thus we can see that we have a fixed number of digits (7) after the #1 Latitude and 6 digits after each of the remaining #2-#7 Latitude degrees, and 7 or 6 digits after each of the degrees of Longitude. Thereby making those numbers right justified, and therefore consistently interpretable by logical, pre-programmed computer processes, even though they contain NO punctuation.

“What about those digits following the space after the degrees? How are they to be interpreted? Since, again, there is NO punctuation (decimal point, spaces, or minute/second symbols) in the original code, we must conclude that they have to be interpreted with a fixed format to be consistently deciphered by a computer.

“Well, if they were in DMS format, we would need the next 2 digits after degrees to represent minutes (00-60), and none of them should be numerically greater than 60. However, we note that 4 of the Latitude number (#2, #4, #6 and #7) violate this, and would therefore be invalid ‘minutes’ values, which leads us to conclude that the format MUST be decimal. This is a very logical conclusion, considering it is the format commonly used for processing Latitude/Longitude in computers.

“Then, after adding the decimal points, the coordinates now look like this:

Possibilities A:

#1A:	52.0942532N	1.3131269W
#2A:	16.763177N	8.9117768W
#3A:	34.800272N	11.1843567W
#4A:	29.977836N	3.1131649E
#5A:	14.701505S	7.5167043W
#6A:	36.256845N	11.7100632E
#7A:	37.110195N	2.5372281E

-OR-

Possibilities B:

#1B:	52.0942532N	13.131269W
#2B:	16.763177N	89.117768W
#3B:	34.800272N	111.843567W
#4B:	29.977836N	31.131649E
#5B:	14.701505S	75.167043W
#6B:	36.256845N	117.100632E
#7B:	37.110195N	25.372281E ”

Final Analysis

Joseph Luciano: “After working with Gary Osborn (another member of the official RFI Team) in the UK, and evaluating the geographic locations pointed to by the two possibility sets (A and B), we concluded that Possibilities B is the more likely interpretation.

“So, we have concluded that Possibilities B are the correctly formatted coordinates from the decoded binary message.”

Summary

Joseph Luciano: “What I have tried to do in this analysis is start with the coordinate numbers EXACTLY as decoded from the binary code message

WITHOUT any changes, and apply logical and consistent mathematical and computer principles to parse them into a meaningful form.

“I have tried to apply the principle of Occam’s Razor, that is: arrive at the conclusions by selecting the competing hypothesis that makes the fewest new assumptions. I have specifically NOT applied any assumptions or changes to conveniently fit some preconceived notion. My goal was to arrive at logical conclusions with the minimal amount of manipulations and assumptions.

“I have presented the final and official complete results of the decoding and interpretation of the RFI binary message [in] the [table] below.”

FINALIZED INTERPRETED COORDINATE SET				
Coordinate Number	Latitude	Longitude	Status	Location
#1 from Pages 1-5 and Pages 14-16	52.0942532N	13.131269W	FINALIZED	Hy Brasil
#2 from Pages 6-13	16.763177N	89.117768W	FINALIZED	Caracol, Belize
#3 from Pages 6-13	34.800272N	111.843567W	FINALIZED	Sedona, Arizona
#4 from Pages 6-13	29.977836N	31.131649E	FINALIZED	Great Pyramid in Giza, Egypt
#5 from Pages 6-13	14.701505S	75.167043W	FINALIZED	Nazca Lines in Peru*
#6 from Pages 6-13	36.256845N	117.100632E	FINALIZED	Tai Shan Qu, China
#7 from Pages 6-13	37.110195N	25.372281E	FINALIZED	Portara at Temple of Apollo in Naxos, Greece
*The Nazca Lines is where the alien bodies were discovered.				

[End of Joseph R. Luciano’s analysis of Jim Penniston’s binary code notes.]

METHODOLOGY FOR TRANSMITTING BINARY CODE THROUGH TIME

I thought it important that you be shown a practical way for ones and Zeros to be sent, and here is the man who thought up just such a method.

“Dr. Ronald L. Mallett is a physicist whose theory that ‘space and time can be manipulated’ to make time travel possible has gained national media attention. His research and theories flow nicely through this easy-to-read autobiography. Mallett is one of the first African-American Ph.D.s in theoretical physics.

Mallett served in the U.S. Air Force for four years. He received his B.S. in physics in 1969, M.S. in 1970, and Ph.D. in physics in 1973, all from Pennsylvania State University. In 1975 he joined the faculty at the University of Connecticut, where he is a professor of theoretical physics. He has published many papers on theoretical physics in professional journals. His time travel research has been featured in an hour-long TV special, ‘The World’s First Time Machine,’ as well as publications as diverse as *The Wall Street Journal*, *Rolling Stone*, *New Scientist*, *The Village Voice*, *The Boston Globe*, and *Pravda*.”
[\[aalbc.com/authors/author.php?author_name=Ronald+L.+Mallett\]](http://aalbc.com/authors/author.php?author_name=Ronald+L.+Mallett)

“[Dr. Mallett’s] ‘Space-time Twisting by Light’ project is, despite the technical-sounding name a project aimed at constructing a time machine.



Dr. Ronald L. Mallett

In a particular fascinating twist, Dr. Mallett has speculated on the only practical way of sending a message back in time: using binary code; to use binary code through time using circular patterns of light to twist space-time, using light to manipulate time. The energy of the light beams will produce a gravitational field strong enough to drag a spinning neutron through time. Dr. Mallett says: ‘Let’s say I’ll call the spin up (1) and I’ll call a spin down (0). So imagine sending a stream of neutrons with spin up, spin up, spin down, spin up . . . what do you call that? It’s binary code . . . which can be translated into a message.’

[*Encounter in Rendlesham Forest* by Nick Pope (New York: St. Martin’s Griffin, 2015), pp. 122–123]

This page has no content.

Binary Code Incident: Wadley, Georgia, USA



Linda Moulton Howe

This is an evidence-based document.

In the case of the 2015 Wadley, Georgia, incident, the unnamed witness is encouraged to come forward and testify so that his story can become part of the official record. Linda Moulton Howe is your expert for both the Rendlesham and Georgia binary code incidents.

"BINARY CODE—SECRET MESSAGES FROM THE COSMOS"

CAM: *The following is my transcription of Linda Moulton Howe's documentary "Binary Code—Secret Messages from the Cosmos," ETs Among Us, S1:Ep5, 20 minutes, by Linda Moulton Howe.*

Linda Moulton Howe: "In the summer of 2015 I get a notice that an extraordinary case has emerged out of the state of Georgia. When I got the email asking me to get in touch with this Army guy, it had a drawing with it.

"It had a sketch of a huge oval football-shaped craft. And it was identified as having been drawn by a military guy. And finally, when I get to talk with him, he says, 'I can't let you use my real name and my family could be in jeopardy. I'm still active army, and the only way I can talk to you is if you can alter my voice.' And he said, 'You have to show me.' And he said, 'We have to do a trial audio. Then you alter it, and I'll tell you if I think it works, or I'll lose my job.'

"Well, we did. I got it altered, then we did a long interview. [His experience] started in the Savannah, Georgia, area where he and his wife, kids, and dog and cat lived. They were packing to leave and move from Hunter Airfield to go to a new assignment in Fort Carson, Colorado. His wife and he decided that they would travel at night when it was cool, and then they would sleep in the day. They determined that it would be easier on the children and pets.

"So, it's now in the late afternoon of June 28, 2015, when they get in the car. In his work (he has been in the army more than a decade) his job is one where they count on him to look at anything that is



Sketch included in email received by Linda Moulton Howe.

in the sky and tell them how big it is, how high it is, whose it is. This is what he does for a living for the United States Army. He uses global positioning satellite information all the time. GPS is as common to him as someone picking up pen and paper. He programmed his GPS in their truck to go up through Atlanta and on up to Colorado. Everything was in order, and they get in. He and his wife said that they should be in Atlanta at an hour that would be in the early morning.

"The next thing they both remember—they remember vividly. They see a light up in the sky. He's still driving, the truck is moving, and they both comment, 'Wow! That's a bright star.' [She imitates whooshing.] Whatever that bright star was, it seemed to just literally pop right in front of the truck, causing him to move over to the shoulder and stop because he and his wife are both staring at what has come down on the road in front of them.

"In his army mind that is so used to calculating distances and sizes, he says, 'This is at least 820 feet in diameter.' It was covering the entire road and off to the sides. And he and his wife later would draw sketches.

"They both saw symbols that were right along the underside, in a centralized area. His wife said she saw what she thought were round lights. And they don't really fully understand what happened because it reaches a point where the whole thing—820 feet—pops out just like it popped in.

"When he comes to, he is numb and fuzzy headed. He starts the truck, and he starts driving. He's going straight on the road that they're on because he's just trying to move on down the road. In about five minutes, they come to a little store,

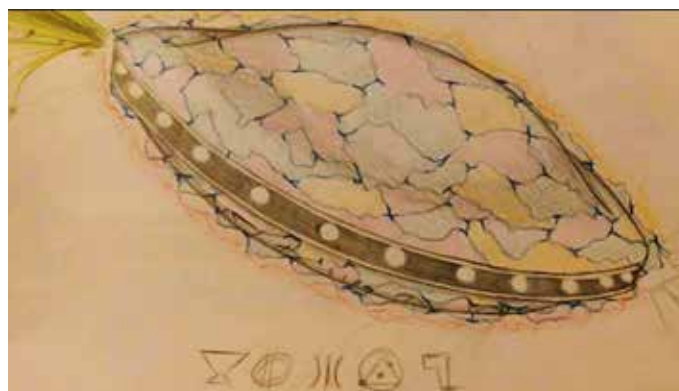

Sketch by the Army sergeant's wife of the craft they witnessed.



The store receipt from Wadley, Georgia.

and he pulls in. It has gas pumps. He had looked at his watch, and he knew, as a military guy, that this thing had popped in at 1:24 a.m., and it appeared to have popped out at 1:29 a.m. He knew that it's now at least 1:35 to 1:45 a.m., and he goes to [get out of] the truck. He said, 'Linda, I had to lean on the door, because I started to try to move my legs and I couldn't move my legs. My entire body felt like I had turned into wet spaghetti.

"He said, 'I literally fell out of the truck, hanging onto the door, trying to make my legs move, thinking, what has happened? What is happening to us? My wife was sitting in a kind of numb situation. We weren't talking to each other. I still felt like I was sort of drunk and numb. We hadn't had anything to drink at all. I knew that something had happened with that big thing on the road, but I didn't know

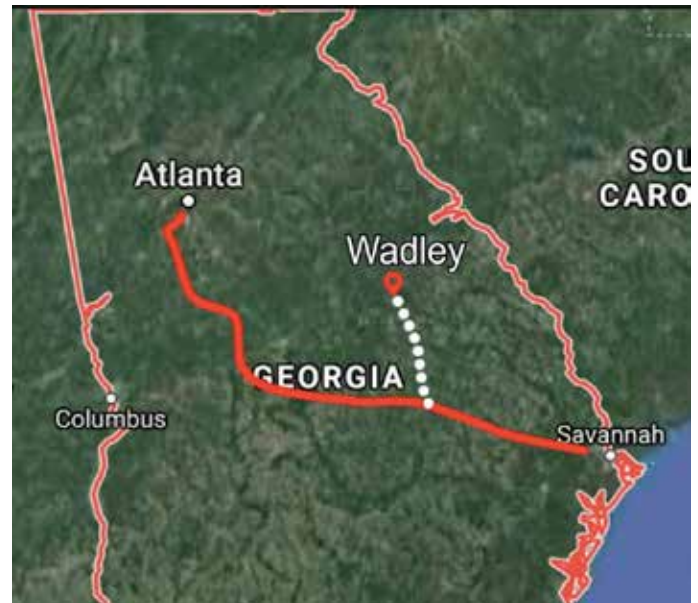

Map showing the relative positions of Savannah, Atlanta, and Wadley, Georgia.

what. After a while I finally could start to feel in my legs, and I start to walk. And, Linda, I couldn't even . . . I was stumbling. Somebody watching me would have thought I was drunk. And I get to the glass door in this gas station's little store, and I get in there, and I got some water, and I got some stuff for the kids and for my wife and me and the cat and the dog. And I looked at the receipt, and the receipt said, "Wadley, Georgia." Wadley, Georgia? That's 90 degrees off the route from where we were in Savannah going up to Atlanta. How could we be in Wadley, Georgia?

"When he gets back to the truck, he explains to his wife, shows her the receipt, and says, 'I don't know what's happening.' They go down the road a little bit more, trying to see if there is an interstate. He realizes, 'We're in rural Georgia. This has nothing to do with any freeway, highway. How did we get off?'

"He does a U-turn. He finally gets back on the interstate. And by sunup they get to a motel that is outside of Atlanta, Georgia, which is where they wanted to go.

"He said they were exhausted. The kids immediately go to sleep. The cat and dog go to sleep. His wife goes to sleep. When he got into bed, there was something; he was troubled. He had fitful dreams.



Above and below: First binary notes from the Wadley, GA, witness.

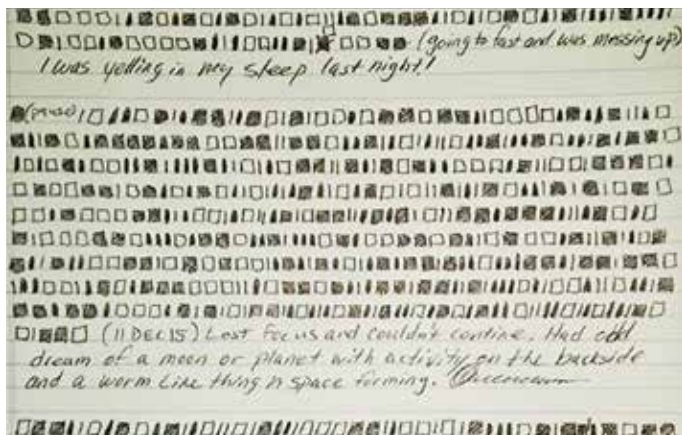
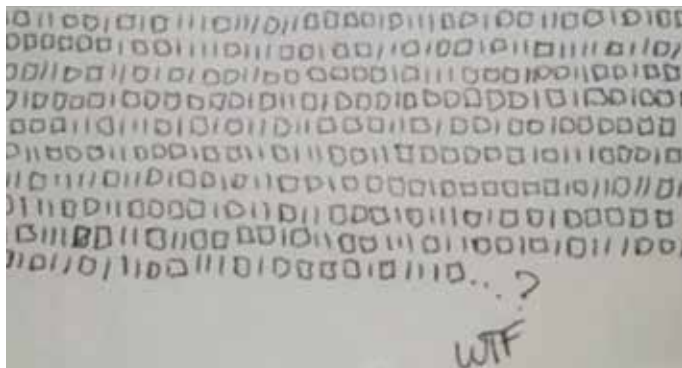

Above and below: Additional binary notes from the Wadley, GA, witness.



“The very next conscious moment—he said, ‘Imagine you’ve gone to bed, and you know that you’ve been on a pillow. But when you open up your eyelids—I had my right arm against the door jamb of the bathroom in the motel. My left arm is holding the receipt—an 8 ½” by 11” receipt that we got. In [my right] hand I have a ballpoint pen. In [my left] hand, the receipt has—completely covering most of it—zeros and ones. And I’m looking at my own handwriting, and the zeros and ones trail off to a WTF, what the?’ And he said, ‘I can’t move. I do not know what is happening.’

“Well by the time he and I got to talk, he was willing to send me not only those zeros and ones, but other zeros and ones that he had gotten for a period of time after this strange event. I began to see that what we had here might be like Jim Penniston at RAF Bentwaters when he was in Rendlesham Forest. If this is now another military person getting a binary code download, then I’ve got to try and translate it. [CAM note: Both men were sergeants.]

“I went to a retired Navy captain and to a geneticist scientist in Australia who is really good with binary code. They both did separate binary code translations. And here is what came into this Army sergeant’s mind, from whatever occurred between when the 820-foot diameter disk stopped them in that road and when they find they’re in Wadley, Georgia.

“[Remember] Jim Penniston [received] a theme that humanity had to advance and that there was some kind of need to have people have a broader consciousness in order to survive. [At this point Linda Moulton Howe gives the army sergeant the alias ‘CJ’.] Here is the translation from [CJ’s] experiences of getting binary code in his mind from June 30, 2015, until January of 2016. During this period of time, he was waking up many different nights, writing down the zeros and ones in a notebook that he kept by his bed. This is how they translated:

Continuous protection of humanity, 49.27 north, 11.5 east. Expose hidden knowledge to all citizens. Advancement imperative for planetary survival. Beware of Orion 1350.3 and Zeta Reticuli 39.70. Avoid signal messages sent

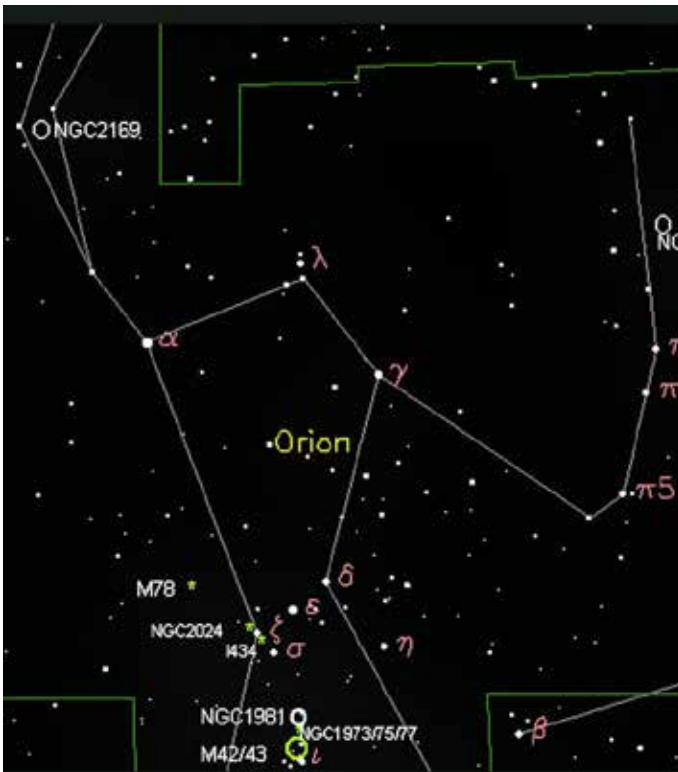

Diagram of the Orion constellation.

“What we found is that ‘avoid signal messages’ appeared to be [a warning:] . . . you’re sending out radio signals, and it’s going to possibly put you in danger. You should not be sending out messages into the cosmos from Earth.

“‘Beware of Orion 1350.3’ turns out that that is exactly the number of light years that would be equivalent from here to Orion, and Zeta Reticuli

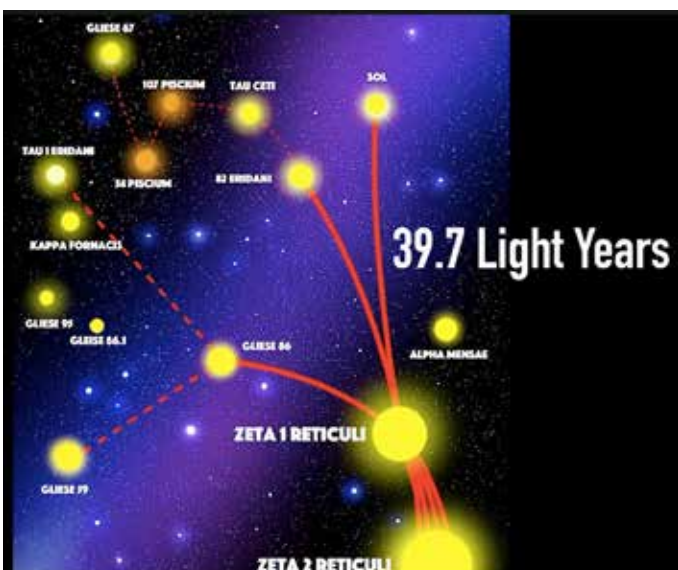
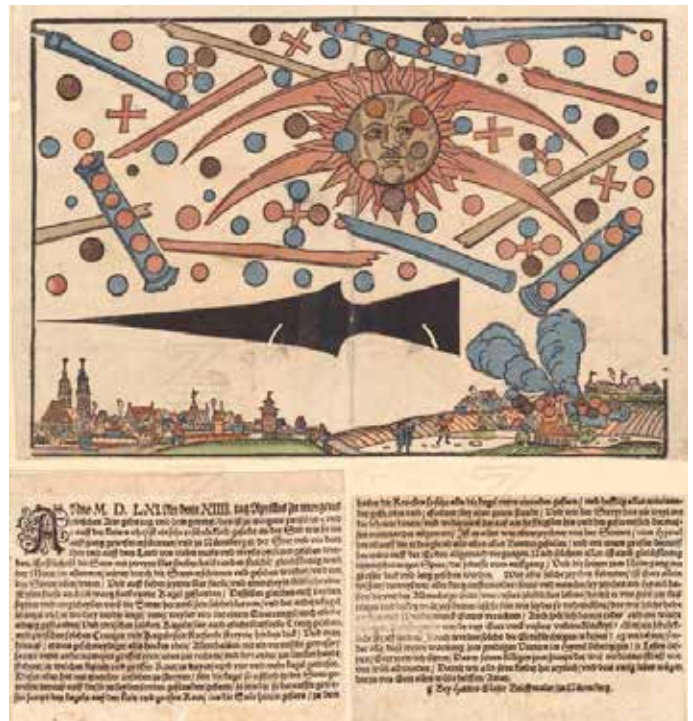

Diagram including Zeta Reticuli 1 and 2.



Woodcut depicting UFO battle over Nuremberg, Germany. Note the smoke rising in the lower right side of the image, which is mentioned in the translation

1 and 2 [a binary star] is 39.7 light years. So this is a message in binary that actually has the light year distances of Orion and Zeta Reticuli embedded in the binary.

“And then when you get to the first line, about ‘Continuous protection of humanity, 49.27 north and 11.5 east’—when you look up that latitude/longitude, it is Nuremberg, Germany. I remember seeing that for the very first time—Nuremberg, Germany; continuous protection of humanity? And I think World War II and the horror of World War II and how the international court was held in Nuremberg.

“This famous woodcut engraving describes a mass battle on the 14th of April 1561 over what is now Nuremberg, Germany. Hundreds of UFOs in various shapes are fighting each other. On the lower right you can see some UFOs are crashing and burning. This is the event referenced [in the] binary code downloaded to Sergeant CJ. The binary coded reference confirms that the event took place, and that it was a battle on our behalf. This is no longer science fiction; it is history.”

NUREMBERG UFO EVENT, 1561

Here is the Wikipedia page outlining the history of the famous woodcut, including a translation of a historical broadsheet published at the time of the event.

[\[en.wikipedia.org/wiki/1561_celestial_phenomenon_over_Nuremberg\]](https://en.wikipedia.org/wiki/1561_celestial_phenomenon_over_Nuremberg)

“A broadsheet news article printed in April 1561 describes a mass sighting of celestial phenomena. The broadsheet, illustrated with a woodcut engraving and text by Hans Glaser, measures 26.2 centimeters (10.3 in) by 38.0 centimeters (15.0 in). The document is archived in the prints and drawings collection at the Zentralbibliothek Zürich in Zürich, Switzerland.^[2]

“According to the broadsheet, around dawn on 14 April 1561, ‘many men and women’ of Nuremberg saw what the broadsheet describes as an aerial battle ‘out of the sun’, followed by the appearance of a large black triangular object and exhausted combattant spheres falling to earth in clouds of smoke. The broadsheet claims that witnesses observed hundreds of spheres, cylinders, and other odd-shaped objects that moved erratically overhead. The woodcut illustration depicts objects of various shapes, including crosses (with or without spheres on the arms), small spheres, two large crescents, a black spear, and cylindrical objects from which several small spheres emerged and darted around the sky at dawn.

“The text of the broadsheet has been translated by Ilse Von Jacobi as follows:

In the morning of April 14, 1561, at daybreak, between 4 and 5 a.m., a dreadful apparition occurred on the sun, and then this was seen in Nuremberg in the city, before the gates and in the country—by many men and women. At first there appeared in the middle of the sun two blood-red semi-circular arcs, just like the moon in its last quarter. And in the sun, above and below and on both sides, the color was blood, there stood a round ball of partly dull, partly black ferrous color. Likewise there stood on both sides and as a torus about the sun such blood-red ones and other balls in large number, about three in a line and four in a square, also some alone. In between these globes there were visible a few blood-red crosses,

*between which there were blood-red strips, becoming thicker to the rear and in the front malleable like the rods of reed-grass, which were intermingled, among them two big rods, one on the right, the other to the left, and within the small and big rods there were three, also four and more globes. These all started to fight among themselves, so that the globes, which were first in the sun, flew out to the ones standing on both sides, thereafter, the globes standing outside the sun, in the small and large rods, flew into the sun. Besides the globes flew back and forth among themselves and fought vehemently with each other for over an hour. And when the conflict in and again out of the sun was most intense, they became fatigued to such an extent that they all, as said above, fell from the sun down upon the earth ‘as if they all burned’ and they then wasted away on the earth with immense smoke. After all this there was something like a black spear, very long and thick, sighted; the shaft pointed to the east, the point pointed west. Whatever such signs mean, God alone knows. Although we have seen, shortly one after another, many kinds of signs on the heaven, which are sent to us by the almighty God, to bring us to repentance, we still are, unfortunately, so ungrateful that we despise such high signs and miracles of God. Or we speak of them with ridicule and discard them to the wind, in order that God may send us a frightening punishment on account of our ungratefulness. After all, the God-fearing will by no means discard these signs, but will take it to heart as a warning of their merciful Father in heaven, will mend their lives and faithfully beg God, that He may avert His wrath, including the well-deserved punishment, on us, so that we may temporarily here and perpetually there, live as his children. For it, may God grant us his help, Amen. By Hanns Glaser, letter-painter of Nurnberg.’ [Colman S. Von Kevicsky, “The UFO Sighting over Nuremberg in 1561,” *Official UFO*, January 1976, pp. 36–38, 68]*

BACK TO “BINARY CODE—SECRET MESSAGES FROM THE COSMOS”

Linda Moulton Howe: “What is the link between timelines on Earth? Timelines of something that may be coming from other dimensions and possibly

from inside this universe—that could communicate to us latitudes, longitudes, and information that seem to tie together, like a weaving of past history events, present events, and implying that there is danger in the future if humans do not advance more quickly?

“When we go to the rest of the binary translation for Sergeant C] here is what it said:

Imminent threat soon upon Earth’s leaders and civilizations. Expose and disband hidden knowledge to all citizens. Employ safe and controlled joint study to all minds. Progression imperative for combined survival.

“The idea here is that if we don’t get the truth out and share it to the whole human family, we end up

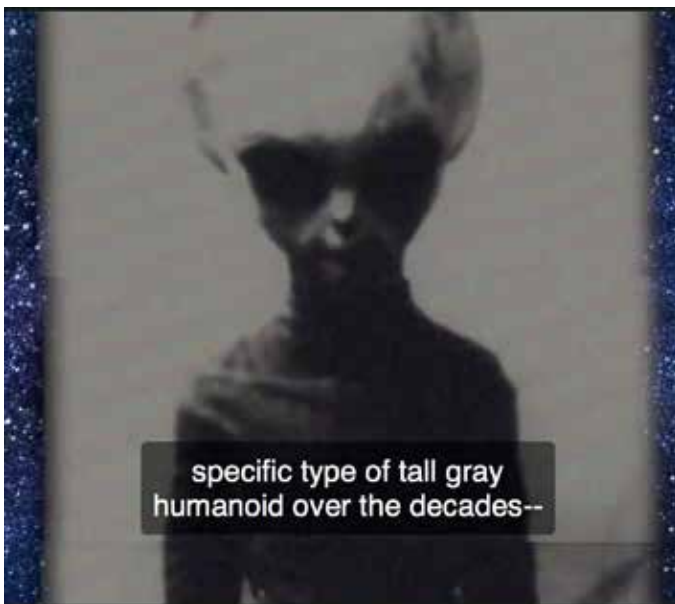

Stills from film footage of an alien (Skinny Bob).

being threatened by something because we will be left in ignorance. It’s essentially what Jim Penniston received in Rendlesham in 1980. And then it goes on into a very interesting paragraph that says,

Royal Emerther warning . . . expose foreign technology to all. Evolutionary advancement needed to prevent takeover. [Note: The term *Emerther* has been assigned to a very specific type of tall gray humanoid over the decades, very mysterious.]

“Takeover by what/who? This leads to a very interesting issue that comes up now. With all of the military people who have been exposed to UFOs and ETs in their work or to people like Sergeant C] and Jim Penniston (a staff sergeant in 1980 in RAF Bentwaters, Rendlesham Forest) [who] receive similar messages.

“There appears to be a theme that also has come up in remote viewers who have worked for the Defense Intelligence Agency (DIA) in the Central Intelligence Agency (CIA)—that the universe is teeming with life. It is way past time for humanity on this planet to be told the truth, and that in all of this life that fills this universe, there are allies and there are enemies and that we humans on this planet would not have survived if we did not have allies who wanted us to survive. They have protected us from those who might want to see us gone from Earth. And that is a theme that I have encountered now in my professional career over and over since 1979, I am still trying to get to bottom of the truth.”

ADDITIONAL INFORMATION

Many people witnessed bright, unknown objects flying across the night sky in the southeastern region of the United States in the very early hours of June 29, 2015.

[See abcnews.go.com/US/mystery-object-lights-sky-parts-georgia/story?id=32100310 and ufosightingsdaily.com/2015/06/slow-ufo-lights-up-sky-over-georgia.html.]

The following is the binary code translation work from the Wadley, Georgia, incident on June 29, 2015.

Complete transcription and translation of the Georgia 2015 binary code

L1 0100-0011 0110-1111 0110-1110 0111-0100
0110-1001 0110-1110 0111-0101

L2 0110-1111 0111-0101 0111-0011 **0010-0000**
0111-0000 0111-0010 0110-1111 0111-0100 0110-0101

Continuous prote

L3 0110-0011 0111-0100 0110-1001 0110-1111
0110-1110 **0010-0000** 0110-1111 0110-0110 **001**

L4 **0-0000** 0110-1000 0111-0101 0110-1101 0110-0001
0110-1110 0110-1001 0111-0100 0

ction of humanit

L5 111-1001 **0010-0000** 0011-0100 0011-1001
0010-1110 0011-0010 0011-0111 0110-11

L6 10 0011-0001 0011-0001 0010-1110 0011-0101
0110-0101 0010-1110 **0010-0000** 0100-0

y 49.27 n 11.5 e.

L7 101 0111-1000 0111-0000 0110-1111 0111-0011
0110-0101 **0010-0000** 0100-1000 0

L8 110-1001 0110-0100 0110-0100 0110-0101
0110-1110 **0010-0000** 0100-1011 0110-111

Expose Hidden Kn

L9 0 0110-1111 0111-0111 0110-1100 0110-0101
0110-0100 0110-0111 0110-0101 **0010-0000** 011

L10 1-0100 0110-1111 **0010-0000** 0100-0001
0100-1100 0100-1100 **0010-0000** 0110-0000

owledge to ALL `

L11 0110-0011 0110-1001 0111-0100 0110-1001
0111-1010 **00** 0110-0101 0110-1110 0111-0011

L12 0010-1110 **0010-0000** 0100-0001 0110-0100
0111-0110 0110-0001 0110-1110 0110-00

L13 11 0110-0101 0110-1101 0110-0101 0110-1110
0111-0100 **0010-0000** 0100-1001 0110-110

citizens. Advancement Im

L14 1 0111-0000 0110-0101 0111-0010 0110-0001
0111-0100 0110-1001 0111-0110 0110-0101 **0**

L15 **010-0000** 0110-0110 0110-1111 0111-0010
0010-0000 0111-0000 0110-1100 0110-000

L16 1 0110-1110 **xxxx**-0101 0111-0100 0110-0001
0111-0010 0111-1001 **0010-0000** 0111-0011 0111-

L17 0101 0111-0010 0111-0110 0110-1001 0111-0110
0110-0001 0110-1100 00

perative for planetary survival.

L18 10-1110 **0010-0000** 0100-0010 0110-0101
0111-0111 0110-0001 0111-0010 0110-0101 **00**

L19 **10-0000** 0110-1111 0110-0110 **0010-0000**
0100-1111 0111-0010 0110-1001 0110-1111 0110-1

L20 110 **0010-0000** 0011-0001 0011-0011 0011-0101
0011-0000 0010-1110 0011-0011 **0010-0**

Beware of Orion 1350.3

L21 **000** 0110-0001 0110-1110 0110-0100 **0010-0000**
0101-1010 **0010-0000** 0101-0010 01

L22 11-0101 0111-0100 0110-1001 0110-0011
0111-0101 0110-1100 0110-1001 **0010-0000** 0

and Z Rutili

L23 011-0011 0011-1001 0010-1110 0011-0001 **1-0001**
0011-0111 0011-0000 0010-1110 **0010-**

L24 **0000** 0100-0001 0111-0110 0110-1111 0110-1001
0110-0100 **0010-0000** 0101-1011 011

L25 1-0011 0110-1001 0110-0111 0110-1110 0110-0001
0110-1100 0101-1101 **0010-0000**

39.1(?)70. Avoid [signal]

L26 0110-1101 0110-0101 0111-0011 0111-0011
0110-0001 0110-0111 0110-0101 0111-0011

L27 **0010-0000** 0111-0011 0110-0101 0110-1110
0111-0100 0010-1110

messages sent.

NOTES

- Three large errors of coding are marked in **blue**.
- Other small errors (for example “Rutili”) are not marked, but may affect proper reading of the code (say as “Reticuli”).
- ASCII “spaces” are labelled in bold with italics.
- ASCII “periods” are underlined.
- An ASCII “accent grave” is marked in purple and underlined. The reason for an “accent grave” before the first letter “c” of “citizens” may be to specify a “soft c” like an “s”, rather than a “hard c” like a “k”. This is also known as “c-cedilla”.
- “49.27 n” and “11.5 e” are the latitude north and longitude east of Nuremberg, Germany as 49 degrees, 27 minutes north or 11 degrees, 5 minutes east at its town centre. Perhaps some human physicists who live there will invent a method to send messages back in time?

- Two numbers “1350.3” and “39.170” tell the distance in light-years from Earth to the Orion Nebula (1350 l-y) or to the binary star system of Zeta Reticuli (39.17 l-y). These are supposedly the home-star systems of “grey aliens”. This new binary code provides such distances with one more digit of accuracy (1350.3 versus 1350, or 39.170 versus 39.17) than is known to astronomers today on Earth.
- “Avoid [signal]” might be warning us not to send radio messages out into space? The format

“[signal]” resembles “Cosmic OS” which SETI plan to use to send such messages.

- Several words show “false capitalization” for nouns inside of sentences. This might suggest a hidden code? On the other hand, it might be how Europeans of the future will write English? A “soft c” for the first letter “c” of “citizens” is not found in any language currently written on Earth.

[\[cropcircleconnector.com/articles/28102015/28102015.html\]](http://cropcircleconnector.com/articles/28102015/28102015.html)

This page has no content.

María



HISTORY

Maria was found in the Nazca region, the same area as the Nazca lines—in the same cave, along with all of the 8+ alien bodies. The diatomaceous earth that all the bodies are covered in is the tie-in proof. She, along with all the others, were brought to light in 2017.



Various views of the Nazca Lines in Peru.

In 2017, Maria was such a distraction for all the critics that the Gaia teams had to spend the majority of their time defending her anatomy. She is complete and unaltered and very likely a new species of human. When her entire gene code is analyzed, she is not going to fall under the genus Homo. My current best guess is that she is a hybrid of some kind. It is entirely possible that she is not from Earth.

MAJOR DIFFERENCES

Maria has an elongated skull similar to the Paracas skulls that also come from Peru. All of the suture lines appear to be fused. She has no external ear tissue and no hair. The construction of Maria's ear and nasal bones is different from ours.

The vertebral count for Maria is reported to be less than that of a normal human, but the researchers don't give the number. She had three fingers and three toes, as well as horizontal toe prints.



Above and below: Ventral and side views of Maria's skull.

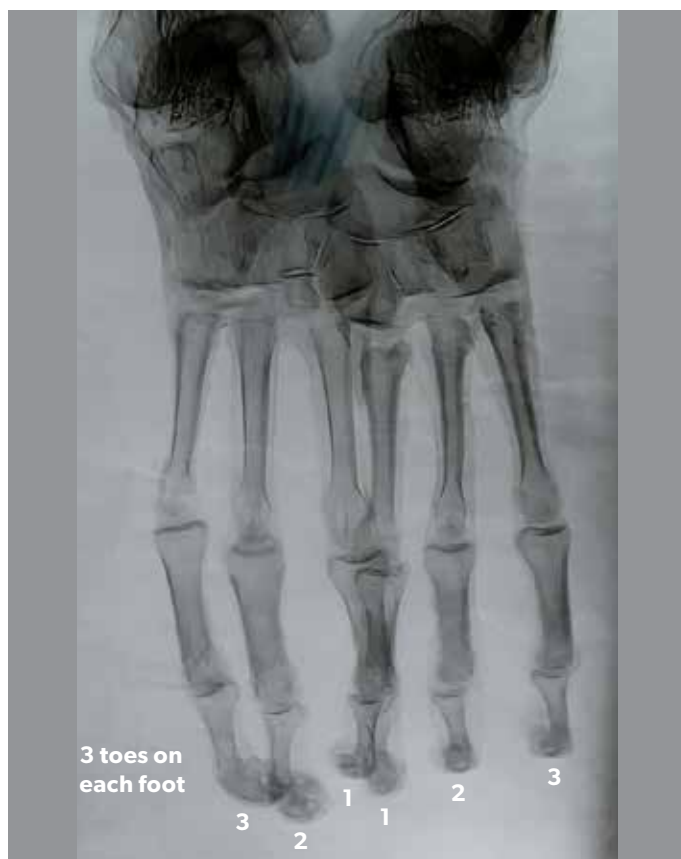

Above: X-ray of Maria's feet. Below: Close-up of toes.



ALL THE HANDS

Found with Maria were three separate hands that are not the same species as Maria. They have a completely different configuration of the metacarpals. Future DNA analysis will be required for the answer to connections or relationships.

There is a phylogeny between human hands, Maria's hands, and the loose hands. I have added a human hand x-ray to help contrast all the differences. Maria's hands fall in the middle. She has metacarpals like ours and three fingers like the three loose hands. Two of the loose hands that were x-rayed are even different from one another. My current best guess is that this is sexual dimorphism in that species. One individual has eight metacarpals and the other ten. What makes them so fascinating is that each has a single metacarpal similar to ours,



X-ray of human hand.

and the others are long and thin. This is a unique arrangement from any species that I am aware of.

Maria's eight metacarpals are similar to ours. It was noted by M. K. Jesse that Maria's wrist bones are thick, and her finger bones are robust.

At least one of the non-Maria hands contained metal on their wrists that appear to be the same as *Moultonus dolani*'s medical device, if that is what it is.



X-ray of Maria's right hand.



Three non-Maria hands.



The carpals of these hands are like nothing ever seen before.



Non-Maria hand with disc.

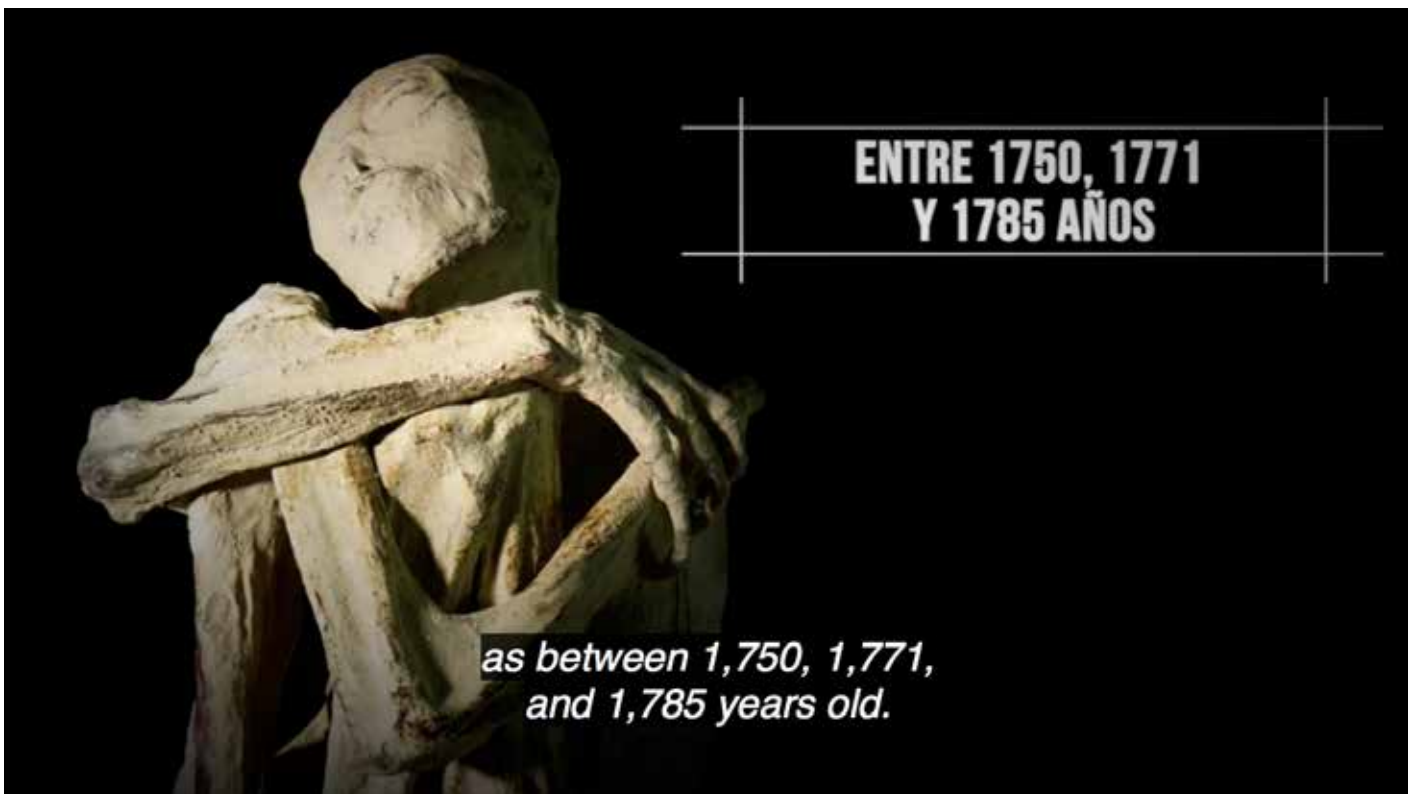

Maria carbon 14 dates.

UNEARTHING NAZCA

Gaia.com series

Update #7 "The Next Sequence"



Dr. William Brown is from the USA. He is a bio-physicist molecular geneticist, MSc. He's done extensive DNA analysis. This is what he had to say about the results of Maria's DNA analysis.

I would say that the beings from which the samples were taken, from which the DNA was analyzed, are not of any known terrestrial origin.

They don't appear to match any species known on Earth. Only 25 percent of the total matched any known human gene. This is pretty rigorous because there's the thousand human genome project. They have done whole genome sequencing of over 2000 individuals from every continent on earth and compiled an average human reference genome. So you take these sequences isolated from the sample from this being, and you go and compare them to the human reference data, that's astounding.

What he is saying here is that only 25 percent of Maria's DNA matched the average from the human genome project.

Alien genetics is likely superior to ours. We can clone sheep. Think about what they can do with a 100 million years' head start. (This is the amount of time "whispered" by the people in the know, for how long the aliens are supposed to have been around.)

PARACAS SKULLS

Maria's skull is an elongated skull and so are those of the Paracas. I thought it necessary to show you examples of the Paracas skulls. All of them need to be reexamined in light of them possibly being of alien origin. In Brien Foerster's studies he discovered that their DNA comes from Europe. One wonders how their DNA got over here from Europe. I think they got a ride in an alien craft.



Brien Foerster

I am wondering . . . how do you get a skull with 25 percent larger cranial volume through head binding? The answer: You don't.

In addition to enlarged cranial volume and unique skull shape, these individuals also have no sagittal suture. They have two posterior foramina on the back of the skull. They have larger eye sockets, as well as an occipital condyle placed an inch more posteriorly. As a dinosaur paleontologist, if these remains were a dinosaur, I would be giving this a new species name. This is something that needs to be done. I propose that *Homo foersteri* is the name that should be applied to this species. These individuals could prove to be alien DNA handiwork.

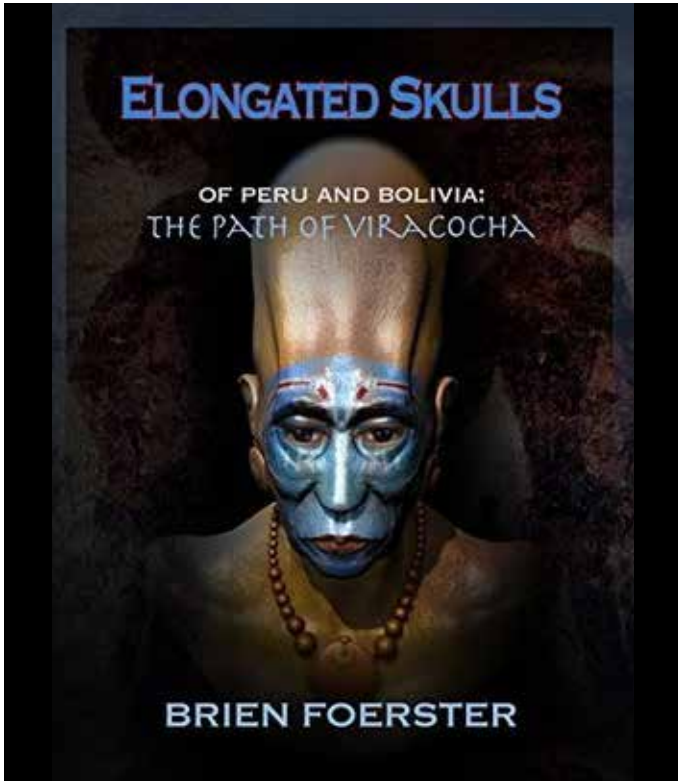

Paracas skulls.



See “Brien Foerster—The Paracas of Peru Were NOT Homo Sapiens Sapiens,” [youtube.com/watch?v=rhgzUhFz4tA](https://www.youtube.com/watch?v=rhgzUhFz4tA).

This page has no content.

UFO Photos

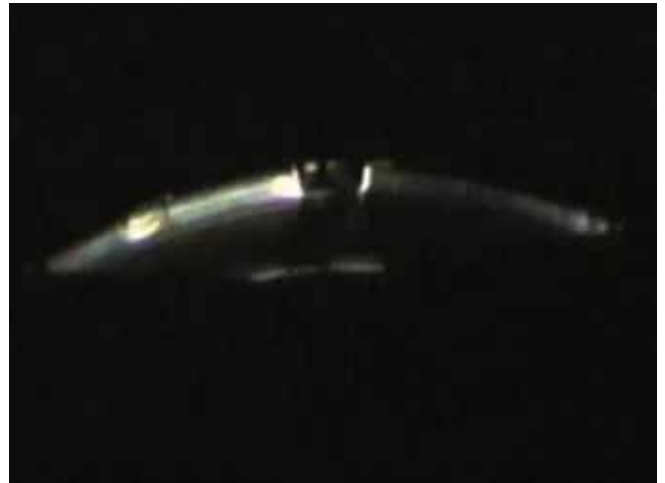
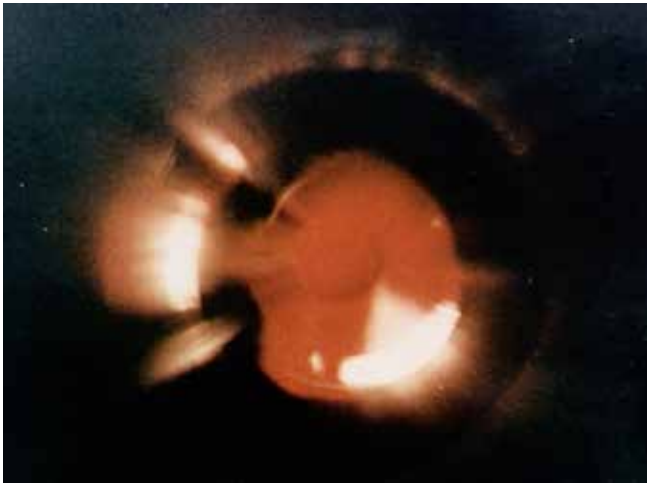

Skeptics complain that there are no good UFO photos or video, however, they are out there for those who want to search for them. No matter what you show skeptics, they will refuse to believe, and that is their prerogative. I have personally seen some wonderful cell phone videos that evaporated off the internet.

The designs of these spaceships are numerous—from the classic flying saucers to cigar shapes, Tic-Tacs, pyramidal (not to be confused with the triangular shaped craft), spheres and lanterns, as well as many others. There are also mother ships, which hold scout craft. Some of these craft are ours, and some are of alien origin. Some craft are reported to be miles long.

It appears that propulsion systems are varied also. Some craft appear to blink out, which suggest that they are interdimensional craft. It is thought by UFO scholars that some craft travel at the speed of thought. One type of craft takes 9 months to travel 40 light years. It is said that they take shortcuts such as worm holes. Some of these ships are navigated by tapping into universal mental connections.

Our universe is connected mentally, which is how close encounters of the fifth kind (CE5) occur. CE5 is human-initiated extraterrestrial contact through technological means or by extra-sensory efforts such as meditation-induced telepathy. (More on CE5 is at the end of this chapter.)

SHEILD-SHAPED UFOS

Mt. Rainier, Washington, June 24, 1947

Kenneth Arnold of Boise, Idaho, was flying near Mt. Rainier, Washington, when he observed 9 UFOs. He reported what he saw and drew an outline of what he had seen. This is when the term flying saucer was used for the first time.

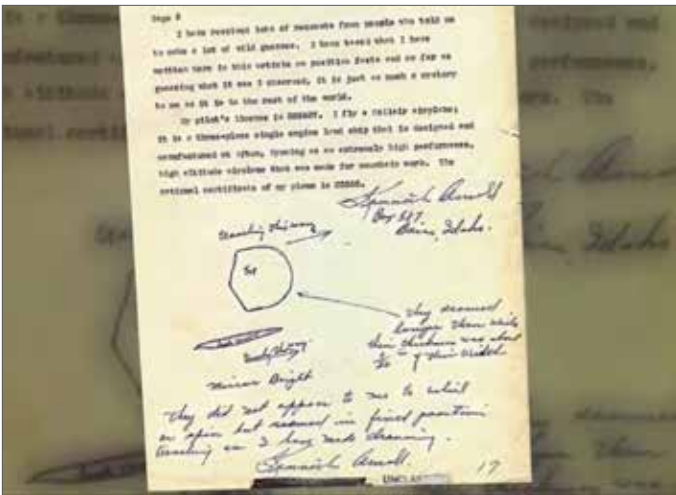

Kenneth Arnold notes and diagram, Mt. Rainier, Washington, June 24, 1947.

Roswell, New Mexico, July 8, 1947

It was at Roswell, New Mexico, where a craft with dead alien bodies was recovered in July 1947. This is when the "necessary lie" for national security began.



Daily Record front page article on the Roswell, New Mexico, incident dated July 8, 1947.

Phoenix, Arizona, July 7, 1947

William Rhodes was walking to his home in Phoenix, Arizona, when he heard a whoosh. Thinking it was a jet, he went and got his camera and took the two photos shown here.



William Rhodes photo 1, Phoenix, Arizona, July 7, 1947.



William Rhodes photo 2, Phoenix, Arizona, July 7, 1947.



William Rhodes story in the Arizona Republic, July 9, 1947.

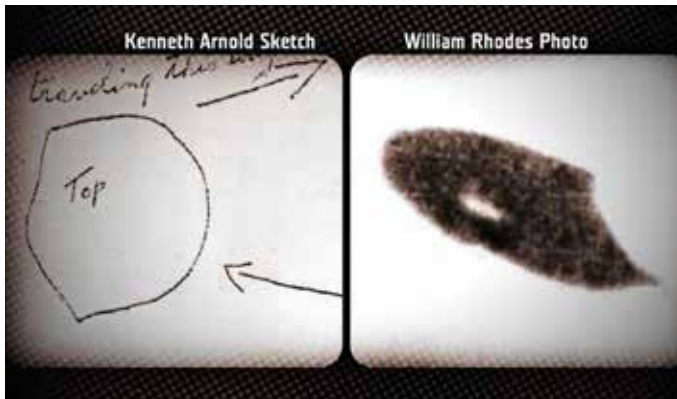

Comparison of Kenneth Arnold Sketch and William Rhodes Photo.

The crossover evidence of the Kenneth Arnold sketch and William Rhodes photos confirm that each was telling the truth.

On July 8, 1947, the day after William Rhodes' sighting, the Roswell incident is reported in the paper. Could the craft involved in the crash have been of the same design?

MCMINNVILLE, OREGON, MAY 1950

The McMinnville UFO photographs, also known as the Trent UFO photos, were taken by Paul and Evelyn Trent near McMinnville, Oregon, United States, on May 11, 1950. The photos were reprinted in *Life* magazine and in newspapers across the nation, and are often considered to be among the most famous photographs ever taken of a UFO.

Although these images have become known as the "McMinnville UFO Photographs," the Trent farm was actually just outside Sheridan, Oregon, approximately nine miles (15 km) southwest of McMinnville, which was the nearest larger town.

Evelyn Trent was walking back to her farmhouse after feeding her rabbits. Before reaching the house, she noticed a slow-moving, metallic disk-shaped object heading in her direction from the northeast. She yelled for her husband, Paul, who was inside the house; he claimed that upon leaving the house, he also saw the object. After watching the object for a short time, he went back inside their home to get the camera. He managed to take two photos of the object before it sped away to the west.



Evelyn Trent



Paul Trent



McMinnville, Oregon, UFO, photo 1.

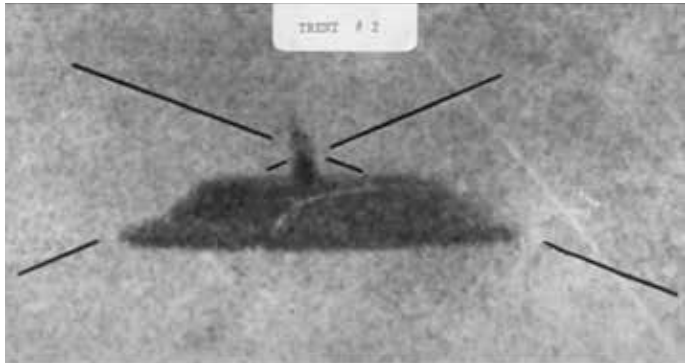

Close-up view with angle analysis.



McMinnville, Oregon, UFO, photo 2.



Time magazine, 60th anniversary of the sighting.



Why did *Time* magazine do a 60th anniversary edition? Simple. It is because the photos and story still hold up.

UFO PHOTOS

This section is arranged in order of occurrence as closely as possible.

OpenMinds

Posted Oct. 11, 2013

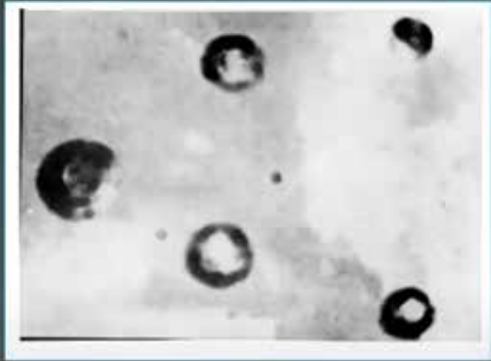



UFO Over Farmington, New Mexico March 17, 1950

The photograph shows 5 saucer shaped objects in a V pattern. The back of the photograph has handwritten notes. The Date: 17 March 1950, the location: Farmington New Mexico, the time: 10:15 and



- Clearly two sequential photos of the same objects in flight
- We know the photo was taken prior to March 24th 1950

Farmington, New Mexico, March 17, 1950.



November 23, 1951, in Riverside, California, Guy B. Marquand claimed that he and two friends saw the object fly past at a very high rate of speed, and when it came back, he took this.



1957 Lake Isabella, California. The UFO was not seen in the shot by the photographer at the time the picture was taken. The original slide was sent to the Los Angeles office of Time-Life Magazine. According to tests conducted it was neither a lens flare or a double exposure or caused by an emulsion and concluded that it was authentic. Time-Life Magazine staff were instructed by the main office in New York to not run the story.



December, 29, 1953, an unidentified flying object in the sky over Bulawayo, Southern Rhodesia.





UFO photographed over Provo, Utah, in 1966.



Taken in 1971 as mapmaker Sergio Loaiza flew over Lake Cote, Costa Rica, capturing the rainforest in 20-second intervals for the National Geographic Institute of Costa Rica. The picture—taken from 10,000 feet—shows a metallic disc flying at a lower altitude.



This is one of three photos of a UFO taken by Rex Heflin on August 3, 1965, near Santa Ana, California. Heflin was an Orange County highway department investigator.



A Tic-Tac, taken before 1997.



Canary Islands 1976. Reported to be huge.



Vancouver, Canada, 1981.

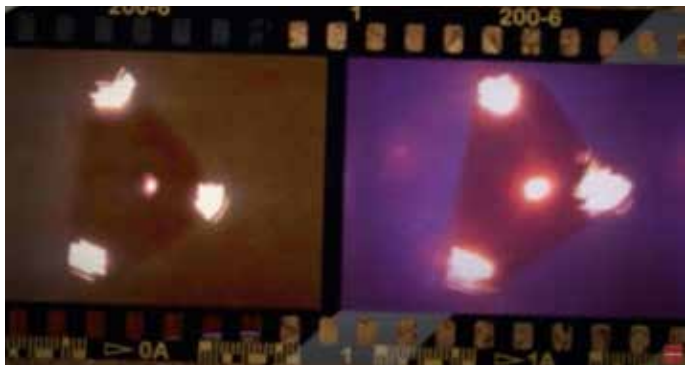

Belgium, 1989, TR-3B.

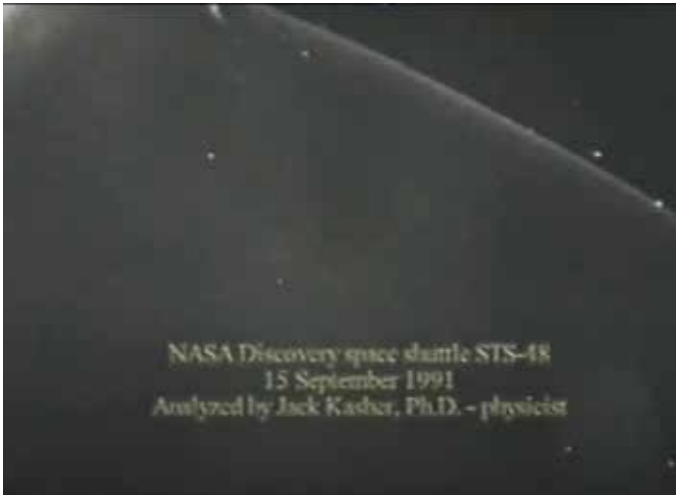

The streak is a weapon we shot at a UFO, which simply moved out of the way. Source: "Ancient Aliens: NASA's Untold Extraterrestrial Encounter (Season 4)," [youtube.com/watch?v=SdnroPUgGSo](https://www.youtube.com/watch?v=SdnroPUgGSo). In the video you see the flash of the weapon. The targeted UFO detects the flash and moves immediately out of the way. NASA explained it away as ice particles, but ice particles don't avoid flashes of light.



Area 52 Dugway, Utah, weapons test (?) Notice the photo above. "Is the Dugway Proving Ground the Real Area 51? | UFOs: The Lost Evidence" [youtube.com/watch?v=Px6MFxIK_i8&t=309s](https://www.youtube.com/watch?v=Px6MFxIK_i8&t=309s).

*Screenshots from Youtube video "Eyewitness accounts in Tepoztlán confirm the 'Ships of Light' / UFOs seen by contactee Carlos Díaz." [youtube.com/watch?v=b3s0tKNaYOU](https://www.youtube.com/watch?v=b3s0tKNaYOU). However, when testing the link again before publication, we found the video is no longer available.



Tepoztlan UFO side view.*



Tepoztlan UFO bottom view, February 1992.*





Gulf Breeze, Florida, 1995. Unpublished photo until 2017.



Phoenix lights, Lynne D. Kitei, March 13, 1997.*



Bonnybridge, Scotland. Phil Trevis photo taken before 1997.

Above and below, source: "Real Life UFO Sightings | Our Life" [youtube.com/watch?v=OURvpiI9500](https://www.youtube.com/watch?v=OURvpiI9500)



Photograph of the moon and close-ups that show a craft that resembles the Phoenix lights.



Illinois, Chicago area, October 31, 2004.

*This UFO was so large that Trig Johnson, a commercial airline pilot, stated, "I could land my commercial airliner on the top of this thing." It "transformed," cloaked, and projected stars onto the underside. Also Trig Johnson's family received a telepathic message, "Don't worry this is just a demonstration." They watched it for a half an hour, and in that time they were able to observe details. Source: "UFO Sends Telepathic Message To A Family | Close Encounters," [youtube.com/watch?v=sfWiOULVRn4](https://www.youtube.com/watch?v=sfWiOULVRn4).



South Carolina, 2007.

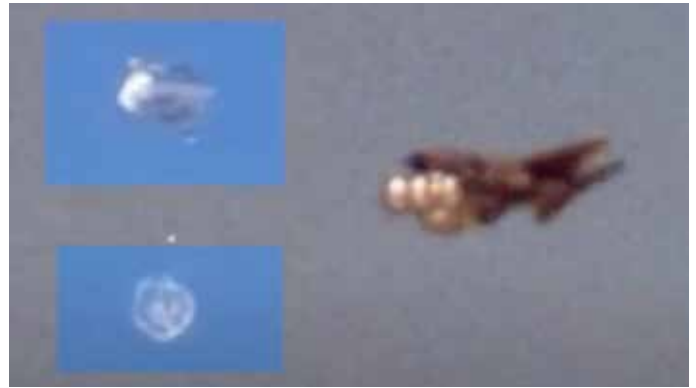

Southeast of Virginia Beach, 2019.

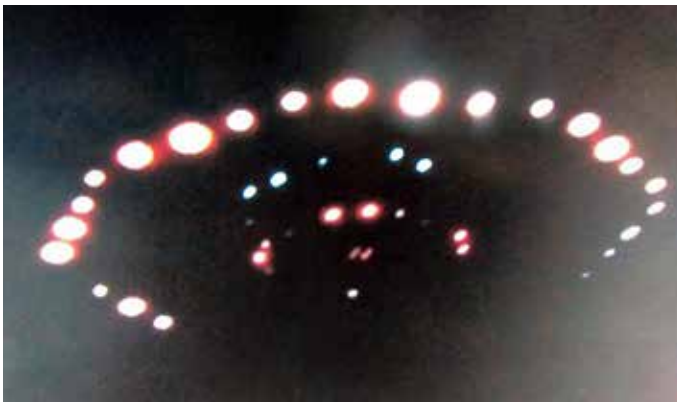

Pyramid craft, 2015.



Filmed fly over image 1.



Filmed fly over image 2.



England, August 16, 2021.



Tic-Tac craft over Utah.
planet-today.com/2020/01/pilot-records-odd-white-cigar-shaped.html#gsc.tab=0

This object in this sequence of images is, in my opinion, a probe. It appeared to be small and shot straight up at tremendous speed. I bookmarked it on YouTube and the video evaporated off the internet.



Screenshot of video showing UFOs moving across the face of the moon. Source: "Ancient Aliens: Japan Reveals Existence of UFOs" (Ancient Aliens season 18), [youtube.com/watch?v=DOI2NL-tLn0](https://www.youtube.com/watch?v=DOI2NL-tLn0)

TURKEY UFO EVENT, 2007, 2008, 2009

Source: Chris Lehto YouTube channel

"Turkey UFO has amazing footage and has not been debunked! 3 years of similar mass sightings w Video"
[youtube.com/watch?v=gJlYf62SdEw](https://www.youtube.com/watch?v=gJlYf62SdEw)

Chris Lehto is a former United States Air Force pilot. He flew F-16s for 18 years. He attended the Air Force



Murat Yalcin Yalman, right

Academy and is originally from Houston, Texas. He now resides in Portugal.

Chris Lehto proved mathematically that the craft was high off the horizon. It hovered over the area on and off over three years. So, what was it doing there? Base resupply?

This video analyzes the unidentified aerial phenomena mass sightings near Istanbul, Turkey, over the summers of 2007, 2008, and 2009. The video evidence comes from one man Murat Yalcin Yalman. He took hours of footage of colored lights and these amazing craft. He shot the video from the same location while the phenomenon hovered over the Sea of Marmaris. Numerous experts have concluded that the footage is genuine.

Dr. Roger Leir (deceased in 2014) was there at a UFO conference when the 2009 video was made. He said on multiple interviews that he saw Yalman take the video, saw the craft with his naked eye, and saw the craft through the telescopic lens.

Additional Sources

Turkey UFO Incident YouTube Channel
[youtube.com/c/TurkeyUFOIncident](https://www.youtube.com/c/TurkeyUFOIncident)

"OBJECTS UNKNOWN - Mystery UFO's in Turkey"
[youtube.com/watch?v=vHfTYHagmOQ](https://www.youtube.com/watch?v=vHfTYHagmOQ)



Turkey UFO, 2008.

Turkey UFO has amazing footage and has not been debunked! 3 years of similar MASS sightings w Video



Chris Leto overlaid the lights shot over the craft to see how they matched up. Chris Lehto YouTube channel.

.25deg=4.36milliradian (mr)
@60,000' away 1mr=60'
4.36mr*60'=261' across



Calculating the size of the craft, photo 1. Chris Lehto YouTube channel.

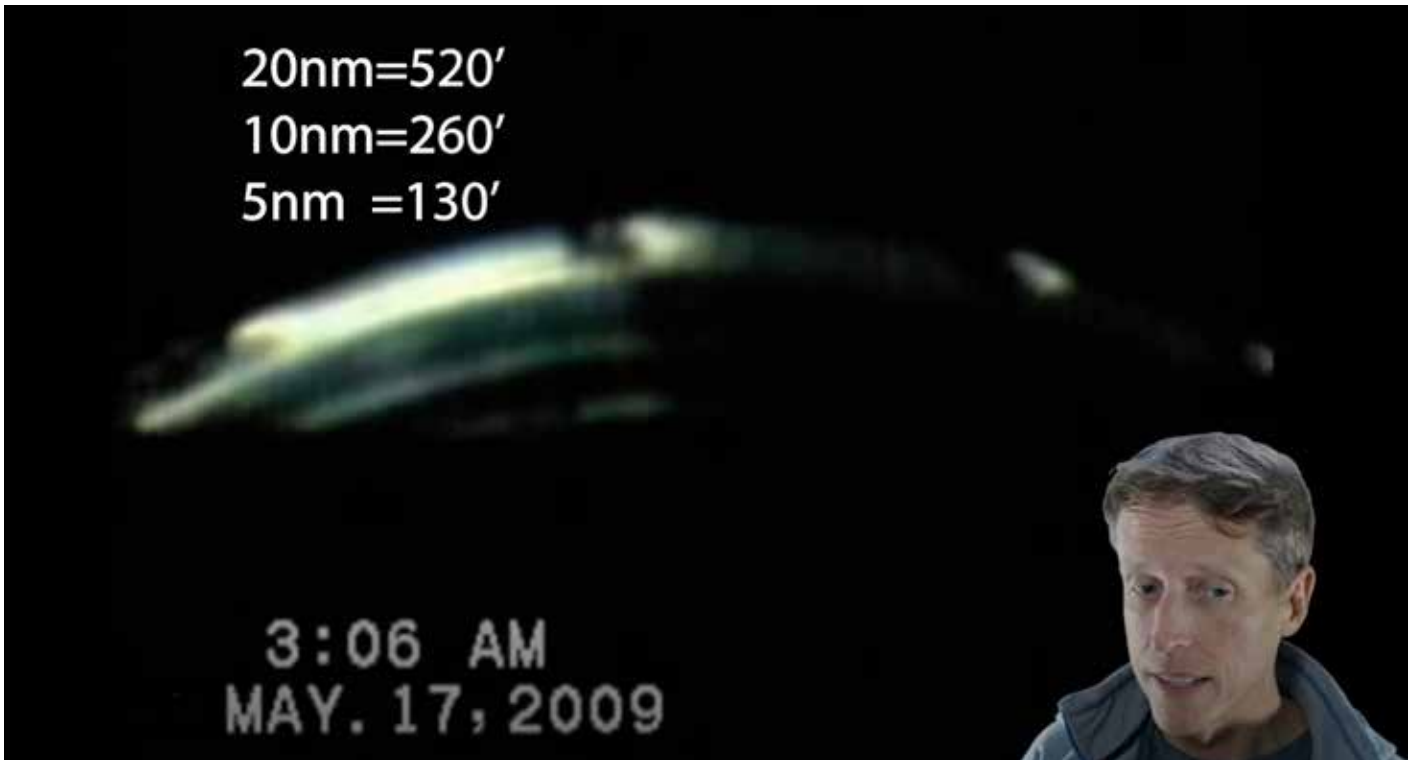

Calculating the size of the craft, photo 2. Chris Lehto YouTube channel.

The MOD website uses cookies to store information on your computer. Most of these cookies are essential to make our site work and others help us to improve it by providing some insight into how the site is used. If you continue to use the website we assume that you are happy to receive these cookies. To find out more about our cookies or to reset your cookie preferences please see our [Privacy and Cookies](#) page.

MOD home | defence for... | about defence | defence news | A - Z index | contact us | help | privacy and cookies

 Ministry of Defence search

Unidentified Aerial Phenomena (UAP) in the UK Air Defence Region

During a policy review in 1996 into the handling of Unidentified Aerial Phenomena sighting reports received by the Ministry of Defence, a study was undertaken to determine the potential value, if any, of such reports to Defence Intelligence. Consistent with Ministry of Defence policy, the available data was studied principally to ascertain whether there is any evidence of a threat to the UK, and secondly, should the opportunity arise, to identify any potential military technologies of interest.

The Ministry of Defence has released this report in response to a Freedom of Information request and we are pleased to now make it available to a wider audience via the MOD Freedom of Information Publication Scheme. Where indicated information is withheld in accordance with Section 26

Freedom of Information
in this section:

- Announcements
- Disclosure Log
- How to make an official request under FOI
- Publication Scheme

Page rated 20 times
★★★★★ Rate

United Kingdom Ministry of Defence UAP Report, image 1. Chris Lehto YouTube channel.

UNITED KINGDOM ARCHIVED UAP REPORT, 2000

In the Turkey UFO video, Chris Lehto also covered the United Kingdom archived Unidentified Aerial Phenomena (UAP) report from the year 2000 that mentions UAP craft and balls of light plasma. It is an amazing read.

"Unidentified Aerial Phenomena in the UK Air Defence Region: Executive Summary, Scientific & Technical Memorandum - No. 55/2/00"

<https://webarchive.nationalarchives.gov.uk/ukgwa/20121110115327/http://www.mod.uk/DefenceInternet/FreedomOfInformation/PublicationScheme/Search/PublicationScheme/UnidentifiedAerialPhenomena/uapInTheUkAirDefenceRegion.htm>

Notable quotes: "The phenomena occur on a **daily**, world-basis." "That UAP exist is **indisputable**." This is from the UK government. What more do you need? Extraterrestrial contact with Earth is real and has been happening for thousands of years. Evidence for it is all over the archaeological record. All you need to do is look. Convincing proof that aliens are here, as well as their craft, is easily found. It is time for ALL the secrecy to stop. What is it going to take for the deception to be lifted and let us have access to all the knowledge and technology?

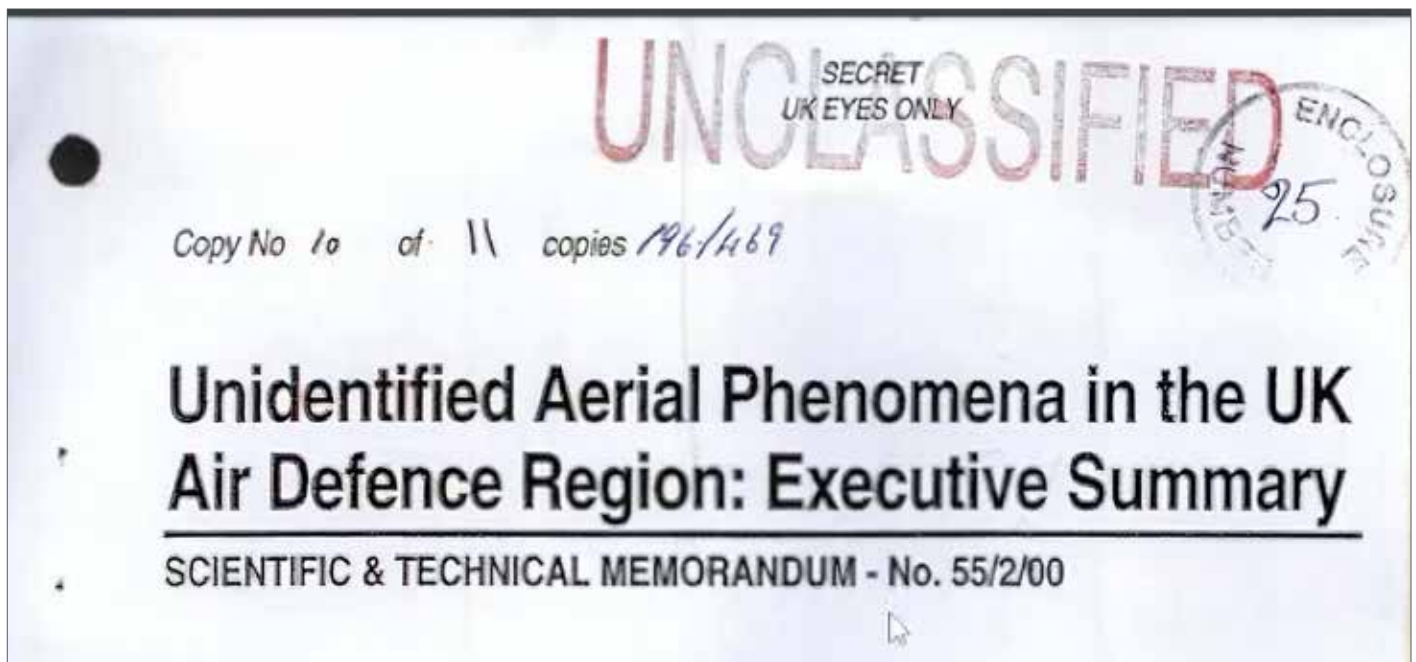

United Kingdom Ministry of Defence UAP Report, image 2. Chris Lehto YouTube channel.

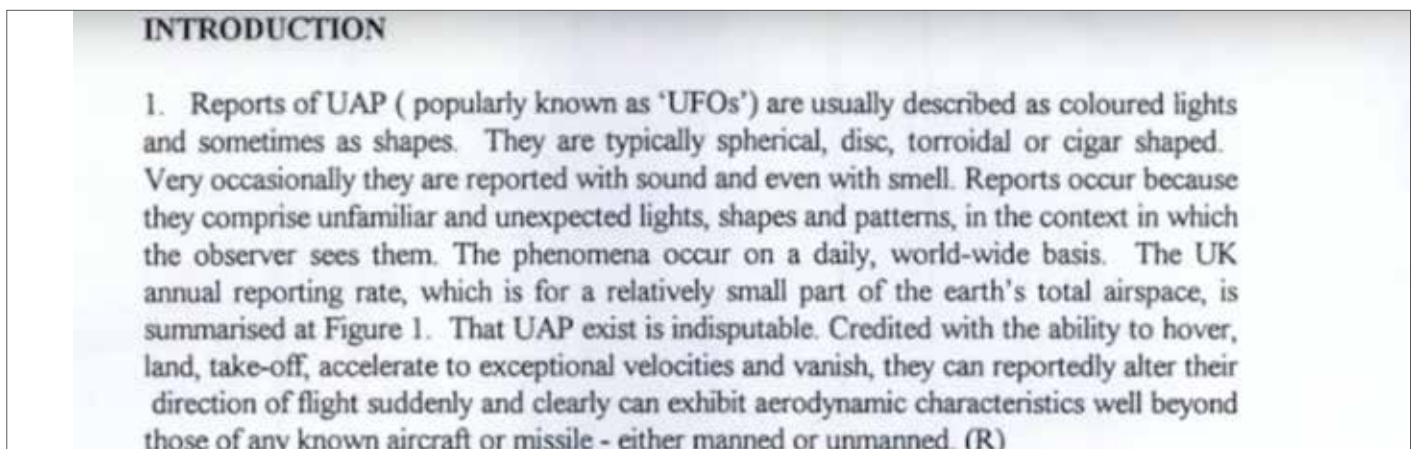

United Kingdom Ministry of Defence UAP Report, image 3. Chris Lehto YouTube channel.

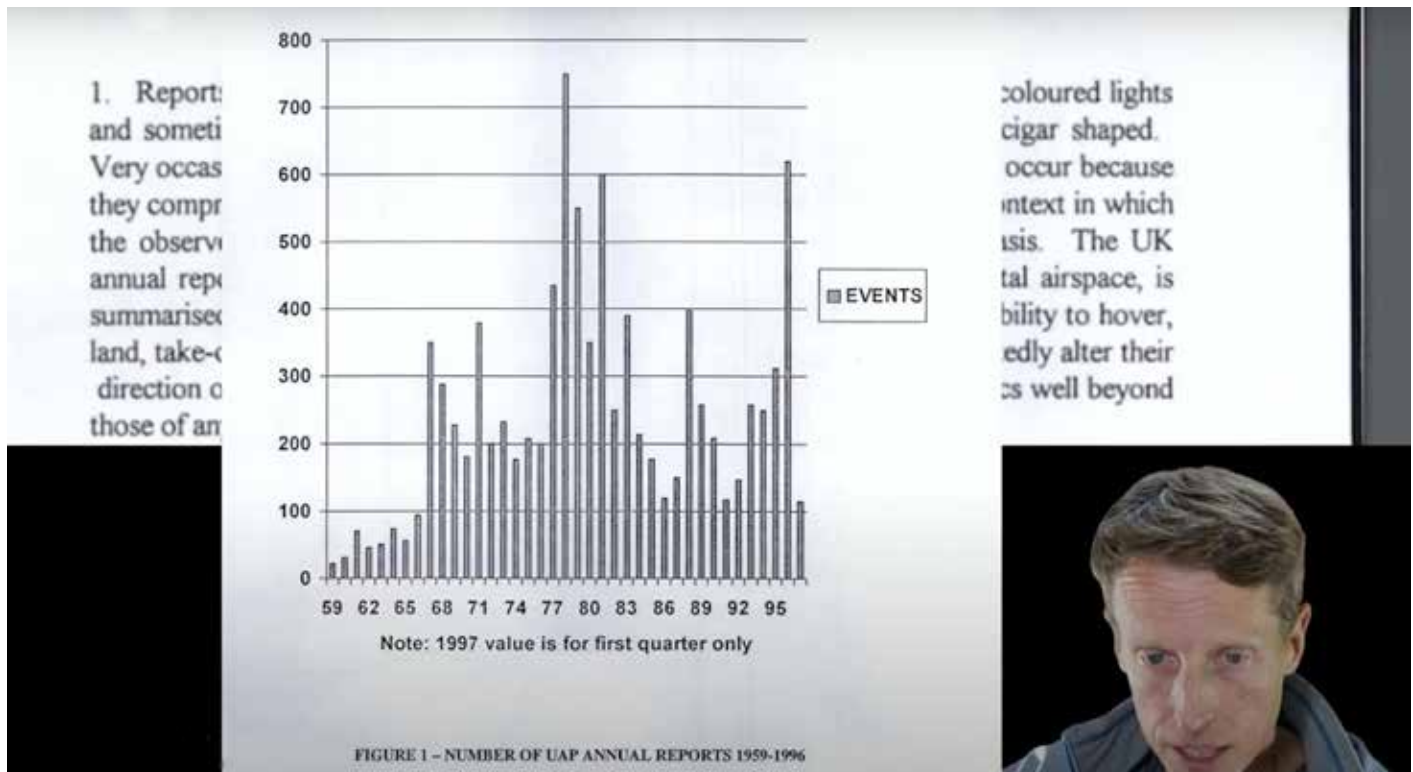

United Kingdom Ministry of Defence UAP Report, image 4. Chris Lehto YouTube channel.

- Occasionally and perhaps exceptionally, it seems that a field with, as yet, undetermined characteristics, can exist between certain charged buoyant objects in loose formation, such that, depending on the viewing aspect, the intervening space between them forms an area (viewed as a shape, often triangular), from which the reflection of light does not occur. This is a key finding in the attribution of what have frequently been reported as black 'craft', often triangular and even up to hundreds of feet in length. (Volume 2, Paper 18)
- The close proximity of plasma related fields can adversely affect a vehicle or person. For this to occur the UAP must be encountered at very close ranges. A probable modulated magnetic, electric or electromagnetic (or even unknown) field

UNCLASSIFIED

UK EYES ONLY
UK RESTRICTED

SECRET

United Kingdom Ministry of Defence UAP Report, image 5. Chris Lehto YouTube channel.

- The close proximity of plasma related fields can adversely affect a vehicle or person. For this to occur the UAP must be encountered at very close ranges. A probable modulated magnetic, electric or electromagnetic (or even unknown

UNCLASSIFIED
 UK EYES ONLY
 UK RESTRICTED
 SECRET

7

SECRET
 UNCLASSIFIED
 UK RESTRICTED
 UK EYES ONLY

SCIENTIFIC & TECHNICAL MEMORANDUM 55/2/00

United Kingdom Ministry of Defence UAP Report, image 6. Chris Lehto YouTube channel.

field), appears to emanate from some of the buoyant charged masses. Local fields of this type (probably either an electromagnetic near-field, or a direct magnetic field) have been medically proven to cause responses in the temporal lobes of the human brain. These result in the observer sustaining (and later describing and retaining) his or her own vivid, but mainly incorrect, description of what is experienced. Some observers are likely to be more susceptible to these fields than are others, and may suffer extended memory retention and repeat experiences. **This is suggested to be a key factor in influencing the more extreme reports found in the media and are clearly believed by the 'victims'** (Volume 2 Papers 1, 2 and (with experimental results) Paper 25)

- Those closest to the event but located in vehicles or behind obstacles, appear to be partially or fully screened from the radiated field and any radiant heat. Rare effects are reported in some very rare instances to be sufficient to cause scorching of human skin and damage to nearby terrestrial objects. (Volume 2, Papers 1



United Kingdom Ministry of Defence UAP Report, image 7. Chris Lehto YouTube channel.

CE5 EVENTS

CE5 is a globally effective technique to make viable contact with ETs, based on the work of Dr. Steven Greer, founder of CSETI.

His mission is to not leave the military elite in charge of intergalactic ambassadorship, but to teach “We the People” to open our hearts and minds to these advanced species and enter into peaceful interactions.

CE5 events involve groups of people coming together to mentally connect with whichever ET race happens to be in the neighborhood. Not all attempts are successful, but enough succeed that the following photos have been produced.

While I have no direct personal familiarity with CE5 activities, my own experiences of connection to the spirit/universe during my life leads me to believe this is most certainly real.



CE5 event, Mount Shasta, California, 2018.



CE5 event, Melbourne, Australia.



CE5 event, Newport Beach, California.



CE5 event, Ontario, Canada.



CE5 event, Vancouver, British Columbia, September 21, 2019.



Craft blinking out.

IMPORTANT ADDITIONAL UFO LINKS

“7 24 22 Multiple ships crossing powerup”
youtube.com/watch?v=eTXBH30vxDs

“From Beyond UFO Sightings Part 1”
youtube.com/watch?v=WIB_IMYi14s
Chronological history of some of the most important UFO photos in history. He has more than 4,000 photos in his archive.

“From Beyond UFO Sightings Part 2”
youtube.com/watch?v=s5OMu1bkems
At 35:13 it shows the entire sequence and analysis of us shooting at a UFO.

“E.T. Message - ‘We Are Here To Help You, If You Allow Us’... Paul Hellyer (1923 - 2021)”
youtube.com/watch?v=dooHIIKudsQ

“FULL EPISODE: The Gods Were Astronauts”
youtube.com/watch?v=a7Za2sNDjuM
(This is worth your time for past history)

“In Search of Aliens: Nazca’s Ancient Geoglyphs (S1, E9) | Full Episode”
youtube.com/watch?v=g34lDUxodZo

UFOS: THE TRUE STORY OF FLYING SAUCERS, 1956

UFOS: The True Story of Flying Saucers, 1956
youtube.com/watch?v=4bGTLtdwPHM

The above is an hour and thirty minute documentary produced through the United States military. It was used to see how the public would respond to the beginnings of disclosure, and has almost been forgotten. It is well done and worth your time. It concludes with the following statement:

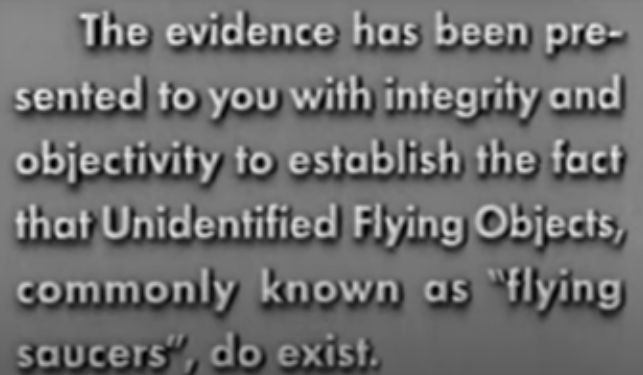

The evidence has been presented to you with integrity and objectivity to establish the fact that Unidentified Flying Objects, commonly known as “flying saucers”, do exist.



THE END
A GREENE-ROUSE PRODUCTION
Released thru **UNITED ARTISTS**

The Ronald Reagan Briefing

This section of the paper consists of the Top Secret: Project Aquarius document from the Reagan library as well as the entire briefing of President Ronald Reagan through CIA Director William Casey about our history of contact with and working with an Eben alien race. It also includes the other four alien races that we were aware of at the time.

When I read through the briefing, I could hear President Reagan's voice in my head. His conversational style is recognizable, and the flow of the document seems genuine to me as well. I am personally convinced of its authenticity.



President Ronald Reagan (February 6, 1911–June 5, 2004) served as the fortieth president of the United States from 1981 to 1989. A member of the Republican Party, he previously served as the 33rd governor of California from 1967 to 1975 after a career as a Hollywood actor and union leader. [From Wikipedia]



William Joseph Casey (March 13, 1913–May 6, 1987) was the Director of Central Intelligence from 1981 to 1987. In this capacity he oversaw the entire United States Intelligence Community and personally directed the Central Intelligence Agency (CIA). [From Wikipedia]

RELEASE 27A—REAGAN BRIEFING

What follows is a transcript of a classified tape recording made at Camp David, Maryland, during a presidential briefing regarding the subject of unidentified flying objects and extraterrestrial visitation of Earth. President Ronald Reagan was present. The recording was made between March 6 and 8, 1981.

[\[serpo.org/release27a.php\]](http://serpo.org/release27a.php)

Casey: Mr. President, good morning. As we discussed in February, this briefing contains some very sensational and some very, very classified information. I am not sure, oh, well, I'm not going to make a decision on who you want in the room. That will be your decision, Mr. President. This will be a real tough one to follow since the briefing starts back, historically speaking, that is, and runs up to recent times. I believe we have prepared a good chronological order of events. I'm sure you, Mr. President, will have many questions.

The list of questions presented to me by Adviser #2 should all be answered during this briefing. I hope they are, more than anyone, especially you, Mr. President, leave this briefing with questions still unanswered. I have asked The Caretaker to conduct this briefing. He is a contract employee of the CIA and is the present custodian of the information. Are we to assume that everyone is present?

President: Well, it will be entirely up to you, Bill. I guess everyone must be cleared for this briefing of information, is that not correct?

Casey: Well, it appears everyone is, but as you will see Mr. President, this stuff is pretty high up on the food chain. We call it ATS or "Above Top Secret." This stuff has its own classification and markings. We have a special container, special printers and copiers for this stuff. Every word of this material is printed on special paper then placed inside special covers. The caretakers have taken special efforts to protect all of this stuff from being released inadvertently or copied by some unauthorized person.

But all of this material is protected by a special group of people. The Caretaker is in charge of protecting this information and all of the other stuff associated with this information. I would prefer that you, Mr. President, decide on who you want in this

room. Remember, this material is a closely guarded secret. Although the gist of the story has been out there for many years, very little of the actual truth has ever been released to the public. Oh, yes, well, by some of the renegades maybe, but many of them have been discredited.

President: OK, Bill, I guess we need Adviser #1, you, Adviser #3 and Caspar here. I think Adviser #2 and Michael can leave.

Adviser #2: Mr. President, excuse me, but I would prefer to leave. I don't wish to know this information. You know, plausible denial or something like that.

Michael Deaver: Mr. President, whatever you wish, I'll do. It would be an interesting subject, but do I really have a need to know? No, I don't think so.

President: OK, I guess that is it.

Casey: Thank you, Mr. President. I will now turn the briefing over to The Caretaker.

Adviser #3: Mr. President, and Mr. Director, I already had this briefing. I can stay or leave. Secretary Weinberger and myself received this a few weeks ago.

Secretary Weinberger: Mr. President, as you know, we have some pending business regarding that Soviet problem in Berlin. I think we might just handle that. Adviser #3 and I will let you close this meeting to just a few.

President: OK, Casp, I guess you and Adviser #3 can leave. Thanks for coming.

Casey: OK, Mr. President, that certainly narrows the audience. I think this is just right.

President: OK, well, I can't wait to hear this. Let's proceed.

Caretaker: Good morning, Mr. President. First of all, I would like to give you a bit of information on my background. But before that, please, Mr. President, if you have questions during this briefing, just interrupt me, sir. I have been employed by the CIA for the past 31 years. I started the caretaking status of this project in 1960. We have a special group of people whom we call "Group 6," that cares for all this information.

President: Good morning, I hope, well, I believe I will ask questions. Bill briefed me back in January, but I'm not sure . . . huh . . . well, was it detailed, no, I don't think so . . . huh . . . OK, well I'm sure Bill didn't tell me all 'cause we only had about one hour.

Casey: Mr. President, I only gave you a quick briefing for the NSDD (National Security Decision Directives) that we want to incorporate into the overall action directives about this subject. Adviser #3, Caspar, and I have details far beyond what I knew before January. The last administration wasn't too keen on making all of this stuff accessible to us during the briefings in November and December.

President: Well, I knew a little about this subject before. Back in 1970. Nixon had all of the good stuff and wanted to share it with some of his friends. Nixon showed me some papers. Not sure about who authored them, but they . . . huh . . . well something about New Mexico and other places. Nixon was pretty . . . huh . . . well, you know, fascinated with it. He showed me something, some kind of object or device that came from one of their craft. Something that was taken from the New Mexico crash site. I don't know if, well . . . huh . . . do we know what it was? I don't think we knew or maybe now, after 11 years, we might know.

Caretaker: Mr. President, I can answer some of those questions. Do you wish for me to begin?

President: Oh, well, what level is this? I mean, what was it called? I don't remember what they called this.

Casey: Mr. President, codeword. It's called Top Secret Codeword. This information is beyond Top Secret as I said before. It has its own classification. It is very compartmentalized.

President: Well, I guess just the minimum. Are we recording this?

Caretaker: Mr. President, no, unless you wish.

Casey: Yes, it is [CIA female transcriber] who is doing that. I think we should. I don't want to make any mistakes later about this. Adviser #4 should also stay, since he is one of the caretakers of the information.

President: Well, I don't want anyone leaking this stuff. Not knowing what we are about to discuss . . . huh . . . oh, well, Bill I guess it is your call. Adviser #4 should stay. I guess he should . . . huh . . . oh, OK, well, you make the call, Bill.

Casey: OK, I guess Adviser #4 will stay. But I think [CIA female transcriber] must stay. I'll make that call.

President: OK, I guess we can do our business first, give me a few minutes. Let's get some food first, or snacks. How long will . . . huh . . . oh, about one hour?

Caretaker: Mr. President, I estimate this will last about one hour, at least the first part of it. This is a very complicated subject to brief. I can do it, but maybe the questions will extend [beyond the first] the time period.

President: OK, I see. Let's take a break and then reconvene.

[Break]

Caretaker: OK, Mr. President, are we ready?

President: Yes, we are, let's go.

Caretaker: Mr. President, as was mentioned earlier, I must say, that this briefing has the highest classification within the U.S. government. I will start with a slide presentation. I have most of this briefing on the slides, but I also have an outline that I have passed out to each [person] in attendance.

President: Oh, OK, so are we . . . can we follow it with the [outline] paper?

Caretaker: Yes, Mr. President, you can follow the briefing with the outline in front of you.

President: Thank you.

Caretaker: The United States of America has been visited by extraterrestrial visitors since 1947. We have proof of that. However, we also have some proof that Earth has been visited for many thousands of years by various races of extraterrestrial visitors. Mr. President, I'll just refer to those visits as ETs. In July 1947, a remarkable event occurred in New Mexico. During a storm, two ET spacecraft crashed. One

crashed southwest of Corona, New Mexico, and one crashed near Datil, New Mexico. The U.S. Army eventually found both sites and recovered all of the debris and one live alien. I'll refer to this live Alien as "EBE 1."

President: What does that mean? Do we have codes or a special terminology for this?

Caretaker: Mr. President, EBE means "Extraterrestrial Biological Entity." It was a code designated to this creature by the U.S. Army back in those days. This creature was not human and we had to decide on a term for it. So, scientists designated the creature as EBE 1. We also referred to it as "Noah." There was different terminology used by various aspects of the U.S. military and intelligence community back then.

President: Do we or did we have others? The number "1" would seem to indicate we had others.

Caretaker: Yes, we had others. Back then, the term was EBE and no number designation. We'll explain how the others came into our knowledge.

President: OK, sorry, I was just wondering and I guess, well, I'm sure the briefing will cover this. Please continue.

Caretaker: All the debris and EBEs recovered from the first crash site were taken to Roswell Army Air Field, Roswell, New Mexico. EBE was treated for some minor injuries and then taken to Los Alamos National Laboratories, which was the safest and most secure location in the world. Special accommodations were made for EBE. The debris was eventually transferred to Dayton, Ohio, home of the Air Force Foreign Technology Division. The second crash site wasn't discovered until 1949 by some ranchers. There were no live aliens at this site. All this debris went to Sandia Army Base in Albuquerque, New Mexico.

President: OK, a question, regarding the first site, how many aliens were in the spaceship?

Caretaker: Five (5) dead aliens and one (1) alive. The bodies of the dead aliens were transported to Wright Field in Ohio and kept in a form of deep freeze. They were later transported to Los Alamos where special containers were made to keep the bodies



Composite from film footage of an Eben (Skinny Bob).

from decaying. There were four (4) dead aliens in the second crash site. Those bodies were in an advanced state of decaying. They had been in the desert for the past two (2) years. Animals and time got to those bodies. The remains were transported to Sandia Base and eventually on to Los Alamos. We determined both crashed spaceships were of similar design and the bodies of the aliens were all identical. They looked exactly the same. They had the same height, weight and physical features. Here are the photographs of the aliens.

[Pause]

President: Can we classify them? I mean can we . . . well, connect them with anything Earthly?

Caretaker: No, Mr. President. They don't have any similar characteristics of a human, with exception of eyes, ears and a mouth. Their internal body organs are different. Their skin is different, their eyes, ears and even breathing is different. Their blood wasn't red and their brain was entirely different from human. We could not classify any part of the Aliens with humans. They had blood and skin, although considerably different than human skin. Their eyes had two different eyelids. Probably because their home planet was very bright.

President: Maybe I'm getting ahead, but do we know where they came from? Mars, our system or where?

Caretaker: Yes, Mr. President, we do know where they come from. I can go into this now, or I can wait until it comes up in the briefing.

President: No, no, please, continue. I can wait.

Caretaker: Thank you, Mr. President. EBE stayed alive until 1952 when it died. We learned a great deal from EBE. Although EBE did not have voice organs like humans, it was able to communicate with an operation performed by military doctors. EBE was extremely intelligent. It learned English quickly, mainly by listening to the military personnel who were responsible for EBE's safety and care.

EBE was housed in a special area at Los Alamos and Sandia Base. Although many different military doctors, scientists, and a select number of civilians studied EBE, it never became upset or angry. EBE helped us learn from all the items found in the two crash sites. EBE showed us how some of the items worked, such as a communications device. It also showed us how various other devices worked.

President: Excuse me, but you are referring to this creature as an IT. Did it have a gender?

Caretaker: I'm sorry Mr. President, but yes, it was male. Within EBE's race they had males and females.

President: OK, thank you. Please continue.

Caretaker: Thank you, Mr. President. EBE died of what military doctors considered natural causes. I don't think we could really state exactly why EBE died. Although we had five (5) years to study EBE, we didn't have any standards to compare EBE's body with standard medical observations. It was difficult to lose EBE, since it was the most interesting thing we as humans could receive and study. A visitor from another planet . . . another world. EBE did explain where he lives in the universe. We call this star system Zeta Reticuli, which is about 40 light-years [38.42] from Earth. EBE's planet was within this star system.

President: OK, where is this in comparison to something we all know?

Caretaker: Well, Mr. President, our closet star is four light-years away. I can show you the constellation it is in.

President: No, I wouldn't know much about astronomy. I just thought I could understand the distance. How long did it take this spaceship to get here?

Caretaker: Well, Mr. President, I can tell you now or we can discuss that in another briefing. As Mr. Casey said, this is a complicated subject because there are many levels of compartmentalization. This briefing is just the basic information about a visit to our planet by one particular alien race.

President: Well . . . huh . . . what, am I to understand . . . this isn't a full briefing?

Casey: Mr. President, we have different levels of stuff. If we mix it up, I don't think it will make sense, nor will we have time this morning. I understand you have a busy schedule today.

President: As the President of the United States, I should know everything, right, or shouldn't I? If I am to assume this was a briefing of substance, then I should hear all of it. I think this is more important than some other things on my daily calendar. But maybe I'm jumping the gun. If there are some things I shouldn't know, please tell me.

Casey: No, no, Mr. President, I didn't mean you shouldn't know this stuff. I simply meant we should

proceed in an orderly fashion as to the briefing. But it is up to you. We will not hold anything back.

President: Adviser #1, what do you think? Do you know about all this?

Adviser #1: Mr. President, yes, I was briefed many times on this subject matter. As Director Casey stated, this is a very, very complicated subject. I think it took me about one year to be fully briefed into all aspects of this matter. There are different areas. The initial crash, an investigative period, some attempt at contact, a disinformation operation to protect this matter and several other levels.

President: Oh, wow, I didn't realize how complicated this was. I'm new at [all of] this. I have a great responsibility to the citizens of this nation to make decisions based on accurate information presented by my advisers . . . you, all of you. I won't interfere in your presentation of this information. So, I guess, we'll proceed in the order you have chosen. I'm sorry for interrupting in this presentation, but as a person who is interested beyond belief in this, I'll just shut up and wait to ask questions.

Casey: Mr. President. No, no, please ask any questions you wish. You are the President. We are not here to argue with you over the order of this briefing. But some things are so highly classified that this briefing is the lowest level. If you ask a question that is in a different level, then we will have to re-evaluate the audience.

Adviser #1: Mr. President. Everything we know about alien visitation to Earth is contained in 16 (sixteen) volumes of binders. These binders contain thousands of pages. We can give you anything you wish but, as Director Casey said, we must evaluate the clearances of each person listening to our responses.

President: OK, I now understand. Give me whatever you want and I'll continue to ask questions. But if you need me to wait on an answer, just tell me.

Casey: OK, Mr. President we will do that. I still don't know the entire story. I have read one tenth of one binder and have hundreds of questions.

President: OK, let's continue.

Caretaker: Mr. President, thank you for those responses. I will answer any question, if I can. But if the question is above this level, then Director Casey will have to make that decision for me.

President: I fully understand, please continue.

Caretaker: It took the EBE spaceship nine (9) of our months to travel the 40 [38.42] light-years. Now, as you can see, that would mean the EBE spaceship traveled faster than the speed of light. But, this is where it gets really technical. Their spaceships can travel through a form of "space tunnels" that gets them from point "A" to point "B" faster without having to travel at the speed of light. I cannot fully understand how they travel, but we have many top scientists who can understand their concept.

President: Well, I certainly couldn't understand the science in that. Is it a black hole?

Caretaker: Mr. President, something like that, but much more complicated.

President: Do they get here . . . no never mind, please continue. [unintelligible]

Casey: Mr. President, I can assure we know how they do it, but we can't do it.

President: OK. [several speaking at once]

Caretaker: As to some history. The original project, started back in 1947, was called "Project Gleem." This project contained volumes of documented information collected from the beginning of our investigation of UFOs and Identified Alien Craft, or "IAC." The project was originally established in the early '50s by, first President Truman and then by order of President Eisenhower, under control of the National Security Council. President Truman established a group of people to handle this project. The group was called Majestic 12 or "MJ-12."

In 1966, the project's name was changed to "Aquarius."¹ The project was funded by confidential funds appropriated within the intelligence community's budget. The recovery of these alien spacecraft led the United States on an extensive investigative program to determine whether these aliens posed a direct threat to our National Security. As you might remember, Mr. President, our country openly

investigated UFO sightings under projects Grudge, Sign and finally Blue Book.

The original mission of the Air Force program was to collect and analyze all reported sightings and incidents involving UFOs and then determine whether the information could be interpreted as having any bearing on the national security of the United States. Some information was evaluated with the idea of using the gained data to advance our own space technology and future space programs.

About 90 percent of the estimated 12,000 reports analyzed by the Air Force under Blue Book were considered hoaxes, explained aerial phenomena or astronomical objects. The other 10 percent were considered legitimate alien sightings and/or incidents. However, not all UFO sightings or incidents were reported under the Air Force programs of Grudge, Sign, and Blue Book.

In 1953, Project Gleem initiated its own investigative detail and certain sightings were reported directly under Gleem rather than one of the other projects. Project Gleem, which became “Project Aquarius” in 1966, was a parallel reporting system for UFO sightings and incidents.

Reports collected under Project Aquarius were considered actual sightings of alien spacecraft or actual contacts with alien life forms. We recovered two alien spacecraft from New Mexico. Both were heavily damaged, but we were able to examine them. The two craft were considered technological marvels by our scientists. However, the operating instrumentation was so advanced that our scientists could not decipher it. The two craft were stored in a special security location in the West. We gained a large volume of technological data from these craft.

Several independent scientific investigations, at the request of the Air Force and CIA were initiated during the era of “Project Blue Book.” MJ-12 decided that officially the Air Force should end their investigation of UFO sightings. This decision was arrived at during the NPNN meeting in 1966. The reason was two fold. First, the United States had established communications with the aliens.

President: Hold on, OK . . . well, Bill, no . . . never mind, please continue.

Casey: Mr. President, the communications project is of a higher level. I recommend we continue on this course and then switch to the next, if we have time.

President: OK, you’re steering the boat, Bill.

Caretaker: The United States felt relatively sure the aliens’ exploration of Earth was non-aggressive and non-hostile. It was also established that the aliens’ presence did not directly threaten the security of the United States. Secondly, the public was beginning to believe that UFOs were real. The NSC felt this public feeling could lead to a nationwide panic if we disclosed everything we knew about UFOs and alien visitation. We were involved in one major operation during this time frame that involved our alien visitors. That operation is of a higher level and it will be up to Director Casey to proceed now or wait until later.

Casey: We’ll wait on that part of it. I haven’t been fully briefed, and I would like to be able to know everything about that program before trying to brief the President.

Adviser #1: I agree with Director Casey. That part of the program is really complicated and will require a full day to brief.

President: OK, as I said before, Bill’s the captain of this ship.

Caretaker: It was felt that public awareness of these projects would have jeopardized the future space program of the United States. Releasing our secrets about UFOs and alien visitation would also cause a panic among religious leaders around the world. Therefore, MJ-12 decided that an independent scientific study of the UFO phenomena would be needed to satisfy the public curiosity.

The final official study of the UFO phenomena was accomplished by the University of Colorado under an air force contract. The study concluded that sufficient data did not exist that would indicate that UFOs threatened the security of the United States. The final conclusion satisfied the Government and allowed the Air Force to officially step out of the UFO investigating business.

When the Air Force officially closed “Blue Book” in December 1969, Project Aquarius continued

operation under control of NSC/MJ-12. The NSC felt investigation of UFO sightings and incidents had to continue in secrecy without any public knowledge. The reasoning behind the decision was this: If the Air Force continued its investigation of UFOs, eventually some non-cleared and non-briefed Air Force or DOD civilian officials would obtain the facts behind Project Aquarius.

Obviously, for operational security reasons, this could not be allowed. In order to continue the investigation of UFO sightings and incidents in secrecy, investigators from CIA/DCE and MJ-12 were assigned to military investigative units with orders to investigate all legitimate UFO/IAC sightings and incidents. These agents are presently operating at various locations throughout the U.S. and Canada. All reports are filtered either directly or indirectly to MJ-12. These agents are collecting reports of UFO/IAC sightings and incidents occurring on or near sensitive governmental installations.

Many reported sightings and incidents have occurred over nuclear weapons bases. The aliens' interest in our nuclear weapons can only be attributed to the future threat of a nuclear war on Earth that could affect space. The Air Force has initiated measures to assure the security of the nuclear weapons from alien theft or destruction. MJ-12 feels confident that the aliens are on an exploration of our solar system for peaceful purposes. However, we do have information and that is at another level, that more than one alien species are visiting Earth.

President: Well, that is a lot to digest. I have written down many questions. But let's take a break and come back to this.

[Break]

President: I think we can continue now.

Caretaker: Thank you, Mr. President. I will continue. In the 1976 MJ-12 report, it was estimated that the aliens' technology was many thousands of years ahead of ours. Our scientists speculated that until our technology develops to a level equal to the aliens, we cannot understand the large volume of scientific information we have gained from the aliens' craft. This advancement of our technology may take many hundreds of years.

During our initial program to study the alien's spaceship, we started many different projects. The first project, originally established in 1949, was to collect and evaluate medical information from the surviving alien creature—EBE 1 and the recovered alien bodies. This project medically examined EBE 1 and provided our medical researchers with many answers to the evolution theories.

The next project originally established as part of Project Gleem in 1954 became a separate project in 1966. Its mission was to establish communication with aliens. This project met with positive success and will be discussed later under a different level. Two other projects involved the test flying of an alien ship and the cross technology between our space program and the information we obtained from EBE 1.

Casey: Now, Mr. President, we can move on to questions or a different level. Which do you prefer?

President: Well, I have a lot of questions, so let me ask a few and then we can move on. I guess the first question I have is their life span. How old is EBE 1?

Caretaker: Mr. President, the alien civilization that EBE came from [is what] we call the Eben Society. It wasn't a name they gave us; it was a name we chose. Their life span is between 350-400 years, but that is Earth years.

President: Is time the same on their planet as on ours?

Caretaker: No, Mr. President, time is very different on the Eben planet, which, by the way, we call Serpo. Their day is approximately 40 hours. That is measured by the movement of their two (2) suns. The solar system containing Serpo is a binary star system, or two suns, rather than one, like our solar system.

President: Oh, well, your answer creates more questions. OK, as I understand it, their planet has two suns. Wouldn't that mean the planet was hot? I guess that explains their eyes, having two eyelids.

Caretaker: Yes, Mr. President. Their suns do not set, like ours. There is daylight during their entire day,

with the exception of a short time period where both suns hit the horizon.

President: What is life like on Serpico?

Caretaker: Mr. President, it is called Serpo, spelled S-E-R-P-O. I think that will have to be given in a different level of briefings. Mr. Director. . . .

Casey: Yes, Mr. President, I think we are getting way ahead of ourselves. We have all that information about the visitor's planet, but we would have to present that information in a different briefing.

President: OK, all these levels. Something, I guess, I'll have to . . . well, I'll have to get used to it. Does all classified information have these different levels?

Casey: It is similar to the SIOP briefing you were given in January. We have different levels of clearances and. . . .

President: No, I understand all that, Bill. I fully understand the different levels of clearances. I mean, what about the Soviets? What about the spy operations we have in Russia, comparing the two, this alien information to that, are they on the same level?

Casey: No, Mr. President. This information would be considered at the very top, whereas our spying operation inside Russia would be considered at a parallel level, but not the same.

President: Like apples and oranges, OK, I see. I guess this is more that can be explained in one sitting. What about the travel from Serpo to Earth?

Caretaker: Well, Mr. President, the distance from Earth to Serpo is about 40 light-years. They can travel that in about nine (9) of our months. I am no scientist, but as I mentioned earlier, they can travel that great distance by means of space tunnels. They seem to be able to bend the distance from one point in space to another. Just how they do this, must be explained scientifically.

President: OK, well, very interesting. Are the laws of physics on their planet the same as our planet?

Caretaker: Not exactly. There seem to be a little different laws, especially when it comes to the movement of their planet in relationship to their two suns.

Our scientists don't understand it because it defies some of our laws of physics.

President: Do they use nuclear power, or what type of power do they have in those ships?

Caretaker: Mr. President, we understand very little about their propulsion system. There seem to be two different propulsion systems. One they use within our atmosphere and one they use once they exit our atmosphere. They do not have nuclear power. Their propulsion system does have some type of low level radiation emissions, but nothing that would endanger us. It isn't like our radiation, but we call it radiation because we have nothing else to compare it with.

President: Have these aliens visited other places on earth?

Caretaker: Again, Mr. President, that would be in a different level of discussion.

President: I'm getting tired of hearing that answer, but I understand.

Casey: Mr. President, the Soviet Union has had their contacts with these aliens. We have a great deal of intelligence that would indicate the Soviets had their "Roswell," so to speak. What they know is about the same as we know. They had some bodies back in the late '50s, but our intelligence would indicate the species of aliens were different.

President: OK, well, then Bill, that presents a very disturbing feeling for me. Are you telling me there are different races or species, as you said, visiting Earth at the same time?

Casey: Caretaker, take that question.

Caretaker: Yes, Mr. President, but I hesitate to state the reason. We should have that discussion in a different meeting.

President: Just answer the simple question of how many different species, don't go into details, since I'm sure it is at "a different level," as I've been hearing all morning!

Caretaker: I am sorry Mr. President if I upset you. . . .

President: No, no, Caretaker, don't feel that way. I am not upset. No, you are all of my advisers. As President, I must listen to you and take your advice. I am not upset. I'm sorry for giving you that impression. Can you tell me how many different species have visited us?

Caretaker: Mr. Director?

Casey: Go ahead, Caretaker, answer the President's question.

Caretaker: At least five (5).

President: Are they all friendly?

Caretaker: Mr. Director?

Casey: Adviser #1, would you like to step in here?

Adviser #1: Mr. President, that is a very difficult question to answer. There are many parameters that we follow to evaluate the threat. However, we have little intelligence on four (4) of the five (5). We have plenty of intel on the Ebens . . . gee . . . they've given us everything we asked for! They have also helped us to understand the other four (4) species. I'm afraid to say, Mr. President, and please don't misunderstand my words, but we think one of the species is very hostile.

Casey: Mr. President, do you wish for us to continue on this track or would you like something more private, as to the discussion of this topic?

President: For Christ sakes, I'm the President of the United States. I should know if we are endangered by some threat from outer space. If you have something to say about a threat posed by this one species of aliens, then I want to hear it.

Casey: Mr. President, we have intelligence that would indicate this one (1) species of aliens have abducted people from Earth. They have performed scientific and medical tests on these humans. To the best of our knowledge, no humans have been killed. But, as Adviser #1 stated, the intelligence is from witnesses and we haven't thoroughly evaluated this intelligence.

We have captured one of these hostile aliens. This gets into some very, very sensitive areas, Mr. President. I strongly suggest we end this discussion

and move on to any further questions you might have and then get back to this. I don't think we are prepared to provide you with accurate answers to your questions about the potentially hostile aliens at this time.

President: OK, but expect this to be given to me as soon as possible. I want to know everything about these hostile creatures so I . . . or I mean we should start forming policies on how to deal with them. Adviser #1, do we have operational war plans on this?

Adviser #1: Yes, Mr. President, we have war plans on all potential threats to our country.

President: Please, let us not forget the world. If these creatures attack some other country, we would have to help.

Adviser #1: Mr. President, we have absolutely no evidence that this particular alien race has any plans to attack the United States of America or planet Earth.

President: I guess we really got off the original subject. But I want to know of any threats. Don't hide anything from me! Is that understood?

Casey: Yes, Sir.

Adviser #1: Yes, Sir, Mr. President. We will never hide any information about a potential threat to our country or the world. You receive daily intel briefings and you will continue to and we can update that briefing with any potential threat from this area.

President: OK, let us continue. How many other presidents received this briefing?

Caretaker: Mr. President, I have briefed President Nixon, Ford, and you. President Carter was never given the entire briefing. I have no answer as to why he wasn't given the briefing.

President: Well, knowing that guy, he probably couldn't understand it being from Georgia! But that is just a dry joke. . . . [laughter heard in room]

Adviser #1: Mr. President, I can give you some details of an incident that occurred inside the Soviet Union in 1970.

Casey: Do we want to go there?

Adviser #4: May I say something, Mr. Director?

Casey: Go ahead, Adviser #4, step in.

Adviser #4: I think this particular incident inside the Soviet Union will give the President an example of what the world has and will experience in the future. There is no way we can control visitors from outer space from traveling to Earth and visiting our planet. Some astronomers find it difficult to believe that these aliens can find Earth. We are on the outer reaches of our galaxy. Our sun is one of hundreds of thousands of such stars within our galactic neighborhood. But the Ebens found us, they found Earth. And we are not the only country on Earth that has been visited by the Ebens.

Now, as for the other four (4) species. We know they have visited us in the past and will visit us in the future. We are like a petri dish within the universe. We are a diverse planet. We must be very interesting to other extraterrestrials. I'm sure other intelligent life forms in the universe must have some sort of communications among the [sentient] life forms. Maybe they broadcasted that Earth has intelligent life. Maybe that is why we are [being] visited.

Getting back to Adviser #1, regarding the incident inside the Soviet Union, Mr. President, there are many such sightings all over the world. We must understand that the visitors can roam our planet at will without us doing much about it. However, I personally believe that we must prepare for the eventual day when some hostile life form decides to take over our planet. We must be prepared. I hope you understand why I said what I said, Mr. President.

President: Yes, indeed, Adviser #4, very well said. I agree with you. I guess all of those sightings . . . well, some of them are real . . . I mean, we are being visited, today, now, in this time period.

Casey: Yes, Mr. President, we are.

President: OK, Adviser #1, please continue, we cut you off.

Adviser #1: OK, thanks, Mr. President. As I was saying, actually a series of incidents occurred over about a week. Our intelligence gathering stations inside and outside of the Soviet Union picked up voice transmissions between Soviet Air Defense

pilots and ground controllers regarding a number of UFOs which were being chased by Soviet pilots. The incident started in central Siberia and ended over the Black Sea.

Literally thousands of Soviets observed the UFOs and at least 20 different fighter pilots chased the UFOs. The Soviets attempted on two occasions to shoot down the UFOs, but to no avail. That is probably the best evidence that these things are happening over the Soviet Union. We think these UFOs were the hostile ones. We call them hostile because they tend to land, take humans, conduct experiments on them and then release the humans. Their spacecraft are different in design than the Ebens.

President: Wait one minute, Adviser #1, you mean to say that we have one of their spaceships? Or are you telling me we have some other evidence of their spaceships?

Adviser #1: Mr. President, we have photographs of their ships. This gets a little complicated because some of our intelligence comes from the Ebens.

President: You mean from the EBE guy?

Adviser #1: Yes, but from other sources of information connected to the Ebens.

Casey: Mr. President, we'll have to go to those dreaded words you don't like . . . higher levels if you wish.

President: No, well, no . . . oh . . . OK . . . just give me this briefing first. We can schedule the higher level ones later.

Adviser #1: Simply speaking, we know the difference between the Eben spacecraft and the hostile aliens' spacecraft.

President: Do you have a . . . huh . . . name for them, I mean the bad ones?

Caretaker: May I interrupt, Mr. President?

Casey: Wait, OK, I guess we can proceed.

President: Well, huh. [Too many speaking at once; several conversations not understood.]

[Not understood]

Caretaker: OK. . . . [Several sentences said, but not understood.]

Casey: Yes, go ahead, Caretaker.

President: No, I didn't mean to interrupt.

Caretaker: Thank you, Mr. President. We call the hostile aliens simply that, HAV, meaning Hostile Alien Visitors. MJ-12 placed that code on them back in the '50s.

Casey: OK, we opened the box so let's just tell the president what we know about the others.

Adviser #1: The names? What? [Several sentences not understood.] OK, well, technical? Or what?

Casey: [Not understood], well, [not understood], OK, I guess it means the technical stuff.

President: You mean to say, these H-A-Vs have been visiting us and kidnapping our people since the '50s?

Caretaker: Mr. President, yes, well, they have been around since then, Director Casey. . . .

Casey: Mr. President, we have some indication that they might have been doing this for some time. But we really have to consider all of the evidence, listed in our reports, and compare that to some of the open source information. There are always humans that will exaggerate and just tell lies, compared to the real ones or the ones who were abducted and subjected to experiments. We have to sort through the differences and place some aside and look at the real evidence of abductions. But we can be sure that the Ebens have never done this. They are extremely peaceful and would not harm a living soul, including animals.

Adviser #1: I suggest we go ahead and give the President the information on them.

Adviser #4: I agree.

Casey: OK, give the President the names, Caretaker.

Caretaker: Names, the technical names?

Casey: Yes, OK, [not understood] well about the [not understood] I can live with that, but we have to be real sure that this information stays here. We cannot allow this to flow [not understood] from [not understood].

Caretaker: OK, thank you. Mr. President, the five (5) species are called, Ebens, Archquroids, Quadroids, Heplaloids and Trantaloids. These names were given to the alien species by the intelligence community, specifically MJ-12. The Ebens are friendly; the Trantaloids are the dangerous ones.

President: My God, just knowing we have names for these things are amazing. Which one did we capture?

Casey: Mr. President, we have a Trantaloid, but it is dead. We captured it in 1961 in Canada, and we had it in captivity until 1962, when it died. We'll show you a photograph. . . . Caretaker?

Caretaker: Director, I don't have one with me. But, I will get one couriered over to us.

Casey: Mr. President, we can provide that during our next meeting regarding this subject.

President: OK.

Casey: [not understood] . . . the part of the story where [not understood], but we can look back.

President: OK, let's continue.

Caretaker: Mr. President, getting back to my presentation, all of our collected information is safely contained in a number of locations.

President: Don't tell me where, I don't want to know specific locations. I'll let or leave that up to you and the caretakers of the material. I don't want to be in a position or know this . . . maybe I will later.

Caretaker: OK, Mr. President, I'll keep this in general terms. I just want to assure you that all of the information is safely tucked away at secure locations, including the devices and flying craft that we have.

President: May I assume one of these places is located in California?

Caretaker: Some of the items are tested at Livermore and flown around Edwards, but they are kept in Nevada.

President: OK, yes, I think I was briefed on sensitive military installations back in February . . . west of Las Vegas, I guess.

Caretaker: Yes, Mr. President. We call it the Groom Lake Complex.

President: OK, I was told about that. The same place we have Soviet fighter jets?

Caretaker: Yes, Mr. President, the same place. May I continue?

President: Yes, by all means, do.

Caretaker: In order to protect all this information and the fact that the United States Government has evidence of our planet being visited by extraterrestrials, we developed over the years a very effective program to safeguard the information. We call it “Project DOVE.” It is a complex series of [disinformation] operations by our military intelligence agencies to disinform the public. As you know, Mr. President, we have some highly classified aircraft.

In order to keep these aircraft secret, we tend to convince, at times, the public and press that maybe UFOs are real in order to make the public think what they are seeing are actually UFOs instead of our own secret aircraft even though we know maybe some of the sightings are of actual UFOs. As I said before, this is complicated, but it is a form of counterintelligence. We give the public some actual facts and let them run with it.

The rest is taken care of by them. If you consider the first person who helped us with this disinformation program, Mr. George Adamski, back in the early '50s, and up to all of the movie productions of UFO-related movies. This helps the public to keep their minds open, but also allows us to keep our secret aircraft away from the public's knowledge. That includes some of the craft that were lent to us by the Ebens.

President: I always knew there was some form of cooperation between our government and the motion picture industry. I heard rumors over the years . . . even during my acting days.

Caretaker: Well, Mr. President, the first cooperative venture was the movie, “The Day the Earth Stood Still.” That was a cooperative venture with the United States Air Force and the movie industry.

President: That movie, *Close Encounters*, was that one of them? I guess no “Bonzo” movies were involved. [Loud laughter heard.]

Casey: No [laughing], Mr. President, I don't think or should I say, I didn't think Bonzo came from outer space! [more laughter] [Ronald Reagan played the character Professor Peter Boyd in the September 1951 movie *Bedtime for Bonzo* where a chimpanzee named Bonzo was his costar. [[imdb.com/title/tt0043325](http://www.imdb.com/title/tt0043325)]

President: No, but some people could imagine it!

Caretaker: Yes, Mr. President, we provided the basic subject matter for that movie.

President: Was it based on a real incident?

Casey: Mr. President. . . .

President: OK, Bill, I know what's coming, just forget my question for now.

Casey: OK, Caretaker, continue.

Caretaker: Thank you, Mr. President. In 1949, President Truman created two (2) secret commissions. These commissions were to meet privately without recording any contents. The commissions were code named “Adam” and “Eve.” The first commission, Adam, was to study the idea of releasing some information to the public regarding our actual knowledge of UFOs and the two (2) crash incidents.

The findings of the Adam commission consisted of the following statement: “In this matter, public opinion must be recognized as a factor of considerable importance, even if clearly affirmative might have the effect of placing before the American people a moral question of vital historical significance at a time when the full security impact of the question had not become apparent. If this decision is to be made by the American people, it should be made in the circumstances of an actual disclosure of the existence of space beings who had visited Earth. In other words, the American public might hesitate to believe the existence of space beings unless the American Government showed proof.”

This was an actual quote from the classified document dated 1 December 1949. The second commission, “Eve,” concerned the use of atom bombs to

repel a space alien attack. What's interesting in this statement was the decision by President Truman to proceed at a record pace on the production of atomic weapons that could be released in space. The commission predicted it would take the United States 10 years to develop such a delivery system. President Truman wanted it developed in five (5) years.

In fact, in 1959, the first Atlas ICBMs were targeted for deep space. SIOP plans were developed to counter any space-based alien invasion. Mr. David Lilienthal, the first atomic energy commission chairman, was in charge of the production of enough atomic weapons to counter any anticipated alien threat. The commission was tasked with developing a delivery system that could send a Mark 3 atomic weapon into space.

In the 1948–1949 time frames, there were fewer than 50 atomic bombs in the arsenal and none of these were assembled. The Mark 3 plutonium bombs, like the one dropped at Nagasaki, Japan, took 39 men more than two days to assemble the bomb. The bombs were so large and heavy each weighed 10,000 pounds, and that a delivery system must be capable of sending this heavy weapon into space. As a result of Eve's commission findings, atomic weapons production was increased at a record pace.

Of course, this build-up coincided with the Soviet Union's build-up. It was easy to convince the American public that our build-up was caused by the Soviet Union's build-up. Mr. President, in 1964, we were able to have our very first controlled encounter with the Ebens. Let me first give you the background. EBE was a mechanic, not a scientist. He was still able to teach us some of the Eben language. Their language was very difficult for our linguists to learn because it consisted of tones, not words.

However, we were able to translate some basic words. EBE showed us their communications device. It was a strange looking device that had three (3) parts. Once assembled, the device sent out signals, something like our Morse code system, although there was a problem. During the crash in 1947, one part of this communication system was broken. EBE was unable to repair it until our scientists found some items that could be used in place of the broken parts. Once the communication device was repaired,

EBE sent our messages. We had to trust EBE as to the contents of those messages.

You can imagine what some of our military commanders thought of this. EBE could be sending out a distress call that could result in some invasion. But that, of course, never happened. EBE continued to send messages until his death. But once he died, then we were on our own. We were able to crudely operate the device. We sent several messages out over a six (6) month period (1953). But we did not receive any return messages.

President: Excuse me, did EBE receive any return messages?

Caretaker: Getting back to the messages, Mr. President, EBE sent out six (6) messages. One letting his home planet know that he was alive and his comrades were dead, another explaining the two crashes, the third was a request to be rescued, the fourth was a message suggesting a meeting between his leaders and our leaders. The last message suggested some form of an exchange program.

Casey: Mr. President, we'll go into that later.

President: [not understood] . . . what . . . the exchange program?

Casey: Yes, Mr. President. We can give you another couple of hours on that subject.

President: We had one?

Casey: Can I speak to you privately, please, Mr. President?

President: OK, yes . . . you mean now? [not understood]

Casey: Well, let us put this one on the back burner and go on with the remainder of this briefing.

President: OK.

Caretaker: Mr. President, we don't think he did, but we could not be entirely certain. But, our scientists fine-tuned our efforts over the next 18 months and finally sent two (2) messages in 1955 that were received. We received a reply. We were able to translate about 30 percent of the message. We turned to several linguist specialists from several different universities and even several from foreign universities.

Finally, we were able to translate most of the messages. We decided to reply in English and see if the Ebens could translate our language easier than we could theirs.

President: What did the messages say? The one we received from the Ebens? So, I guess they didn't get the messages sent by EBE? Or did it take that long to respond? Oh, yes, EBE died before we got those messages, never mind.

Caretaker: Mr. President, the first message we received acknowledged our message and asked questions about the crew of the two missing craft. It also gave a series of numbers that we think were some type of coordinates.

President: OK, so they wanted to know the coordinates of the crash sites on Earth? I'm sure they wanted to know about their crew. Did we tell them all but one was dead? No, wait; I'm sure when EBE sent his messages that is probably the first thing he sent. Was EBE a military person or what?

Caretaker: Mr. President, we believe EBE was a member of their air force or maybe something like NASA.

President: OK, please continue.

Caretaker: Thank you, Mr. President. Finally we were able to translate most of the messages. As I said, we decided to respond in English. Approximately four months later, we received a reply in broken English. Sentences contained nouns and adjectives, but no verbs. It took us several months to translate the message. We then sent Eben our typed English lessons in a series of one sheet formats.

Without going into the technical description of the Eben communications device, it was like a television screen and a key pad, but the pad contained several different Eben characters depending on the number of times you held down one key. We were able to transpose our English-typed words into the second part of the device, which was similar to our facsimile transmission system.

It took our scientists some time to perfect this, but it worked. Six months later, we received another English message. This time it was clearer, but not clear enough. Ebens were confusing several different

English words and still failed to complete a proper sentence.

President: Gee, I do that all of the time [sounds of laughter]. I just cannot imagine how an alien race could view our language. We have thousands of different languages on Earth and they probably have just one on their Serpo planet. That is truly amazing.

Caretaker: Yes, Mr. President, I cannot imagine living on a planet with just one language. But we were able to provide the basic skill level for them to communicate in English. It took time, but they realized our efforts. In one message, they provided us with a form of the Eben alphabet with the equivalent English letter. Our linguists had a very difficult time figuring this out. The written Eben language was simple characters and symbols, but our linguists had a difficult time comparing the two written languages.

Over the next five (5) years, we were able to perfect our understanding of the Eben language somewhat and the Ebens were able to better understand English. However, we had a major problem. Trying to coordinate a date, time, and location for an Eben landing on Earth. Even though we could basically understand some Eben and the Ebens could understand some English, we could not understand their time and date system and they could not understand ours. We sent them our Earth's rotation schedule, revolution, date system, etc.

For some reason the Eben's never understood this. In return, the Ebens sent us their system, which was difficult for our scientists to understand because we had no reference to their planet. The Ebens did not explain any astronomical date of Serpo or their system. We then decided to just send pictures showing Earth, landmarks, and a simple numbering system for time periods. We had many problems trying to send pictures using their facsimile system. We couldn't be sure they were receiving what we sent.

We had a lot of trial and errors in doing this. We received back some strange messages from the Ebens, basically big question marks regarding what we sent them as to the pictures. We then decided on narrowing any future landing location for them to the location of their crash in New Mexico. We concluded they must have that location. We are sure

EBE sent that to his home planet prior to his death. We did find some star charts . . . well . . . as we call them, in both crashed spacecraft.

They were difficult to understand because they were on a block that we later figured out went into a certain panel on the crashed craft's instruments. Once the panel was in place, the board showed a star system. In fact, we were able to fit all the found boards into the panel and view many different star systems. We then put to work our astronomers in deciphering the star systems. It didn't take them very long to determine the various star systems. We also found several strange spots on the star charts. We concluded these spots were where the travel space tunnels that EBE described were located.

Our astronomers compared the different star charts and found that they were not consecutive. Meaning that one star chart was from one part of the universe and the next was a chart closer to their home system. Our scientists concluded the spots on the chart were a form of short cuts from one point of space to another.

Some of our top astronomers were briefed into the program in order to study the charts. I'm sure they were given only the minimum amount of information they needed, something like a need-to-know program.

President: OK, that is a lot to absorb. Wow, well, I have many questions, but I guess I'll just wait now. I have something to attend to now. But let us take a short break and come back to this.

Casey: Mr. President, how much time do you have left?

President: Well, Bill, let me check. [Long pause]. I need to call some people on another matter. Give me about 15 minutes. Is that OK?

Casey: Yes, Mr. President, we are here at your disposal.

President: I have listened intently to this briefing. I have many questions, which I realize traverse several different layers of secrecy. I don't want to mix up the different layers. But I can see how government bureaucracy exists. That is one thing I can probably change as President! Bill, let's go to the next layer.

Casey: Mr. President, do you want the same people involved?

President: Yes, let's just continue.

Casey: OK, Caretaker, take over.

Caretaker: Thank you. When EBE was alive, he showed us two devices. One was a communication system and one was an energy device. The communication system did not work without the energy device. Eventually, a scientist from Los Alamos figured out the two systems and connected them. After EBE died, we were able to send transmissions, as I said earlier. EBE built up a strong friendship with a U.S. Army major who was his guardian.

The two of them decided that one of Eben's first messages (of the five sent) was a request for an exchange program between the Ebens and our military personnel. Remember I mentioned six (6) messages. The sixth consisted of landing coordinates for Earth. That information wasn't clearly documented back then. We are not sure of the exact chain of events between EBE and the Major. As I said earlier, we were able to eventually communicate with the Ebens.

Over a period of a few years, we could send and receive information. We finally received a startling message from the Ebens. They wanted to visit Earth, retrieve their spacemen bodies, and meet with Earthlings. They provided a time, date, and location. We figure that the Ebens were continually visiting Earth and had probably mapped it. However, the date was about eight (8) years in the future. Our military figured something was wrong and that maybe the Ebens were confusing Earth time with Eben time. After a long series of messages, it was determined the Ebens would land on Earth on Friday, April 24, 1964.

President: Just how did we figure the date?

Caretaker: Mr. President, these messages occurred over a period of several years. By this time, we both had a working knowledge of the other's seasons, which was based on the Earth's rotation, which also figured into our time periods. We had a working knowledge of their 40-hour days. They were a little

smarter than us, being able to comprehend our language and our time periods.

President: OK, that makes sense. But . . . [not understood] . . . about . . . [not understood] . . . the aliens?

Caretaker: Mr. President, we did have a basic understanding of their language. We could understand basic words and symbols. They understood more of our language than we did theirs.

President: OK, then what happened?

Caretaker: Well. . . .

Casey: Mr. President, this is where things get very interesting.

President: OK, I'm waiting. . . . [not understood]

Caretaker: Our government, specifically, MJ-12 met in secret to plan the event. Decisions were made, then changed many times. We had just about 25 months from the time we finally received their message of the date to prepare for their arrival. Several months into the planning, President Kennedy decided to approve a plan to exchange a special military team. The USAF was tasked as the lead agency.

The USAF officials picked special civilian scientists to assist in the planning and crew selection. The team members' selection process was the hardest to accomplish. Several plans were suggested and then changed. It took months for the planners to decide on the selection criteria for each team member. They decided that each member must be military, single, no children and a career member. They had to be trained in different skills.

Casey: Caretaker, let's just go into the general stuff here, I don't think the President wants to know every single minute detail.

President: Well, if I had the time, I would. [not understood] . . . but, I understand that.

Caretaker: Mr. President, a team of 12 men were selected. However, during this time period, President Kennedy died. The nation was shocked, as you know. . . .

President: Yes, everyone was shocked. I can understand what must have happened during the project when John died.

Caretaker: President Johnson continued the program. When it came time for the meeting, we were ready. The landing occurred in New Mexico. We had everything prepared. We had a hoax landing location just in case it was leaked. The landing occurred and we greeted the Ebens. However, a mix-up happened. They were not prepared to accept our exchange personnel. Everything was placed on hold. Finally in 1965, the Ebens landed in Nevada, and we exchanged 12 of our men for one of theirs.

President: One? Why just one?

Casey: Mr. President, this wasn't clearly documented in the reports that we read.

President: One . . . was this their ambassador?

Casey: Well, something like that. We just called it EBE 2. We'll discuss that later.

Caretaker: Mr. President. Our team of 12 went to the Eben planet for 13 years. The original mission called for a 10-year stay, however, because of the strange time periods on their planet, the team stayed three (3) additional years. Eight returned in 1978. Two died on the planet and two decided to stay.

President: OK, this is just amazing! I can see, about that movie. The movie was based on a real event. I saw that movie. 12 men left, along with Richard Dreyfuss. [*Close Encounters of The Third Kind*, 1977]

Casey: Mr. President, yes, the movie was similar to the real event, at least the last part of the movie.

President: OK, a lot to digest. I want to hear about the hostile ones.

Adviser #1: Mr. President, may I step in here?

President: By all means, Adviser #1, do.

Adviser #1: Well, Mr. President, the hostile alien species is responsible for abducting some humans. We can clearly prove some 80 Americans were abducted from about 1955 until the present; the last known one in July of last year [1980]. We have a special military intelligence unit keeping track of these abductions. We have FBI agents attached to assist us when needed. We have NSA and, in some instances, CIA personnel helping.

Unfortunately, we don't have the technology to know when these hostiles will abduct. We get the information afterwards. We interview the victim and place them under hypnotic trances. Some of the victims remember the entire event without hypnosis, while others need hypnosis to relate what happened. We haven't found one single death directly related to the hostile aliens. We have had deaths that were attributed to the abductions . . . suicides. We recorded five (5) of them.

But, Mr. President, these are the abductions we know about. We have no idea how many other abductions are occurring in this country or around the world. These hostile aliens are pretty sneaky. They seem to appear and disappear, which is beyond our technical understanding. They also seem to float or defy gravity. We have actual photographs of them doing this. We have a classic abduction incident that was recorded by military intelligence personnel. It happened in 1979 near a military base.

President: Where?

Adviser #1: In New Mexico.

President: What's with New Mexico? The aliens seem to like that state. Do we know why?

Caretaker: Excuse me, may I speak?

President: Yes, Caretaker, step in.

Caretaker: New Mexico is similar to the home planet of the Ebens. Since we do not know which planet the Trantaloids come from. . . .

Casey: Wait . . . Adviser #4?

Adviser #4: I think we do. I think the Ebens gave us that information. We know the star group. It is close to our solar system, well, I mean in astronomical terms. Maybe 20–25 light-years away. They are actually closer to us than the Ebens are.

President: So that means they can travel like the Ebens travel? I mean using those black holes or whatever you call them?

Adviser #4: Yes, Mr. President, they can travel in the same fashion as the Ebens. However, according to the Ebens, the Trantaloids use a different form of propulsion. Something like matter versus antimatter.

President: And that means?

Adviser #4: Mr. President, basic physics. . . .

Casey: Mr. President, do you want to go into the physics of this?

President: Oh, no, no, I don't think I'd understand it.

Adviser #4: I was just going to say that we know that when matter is placed next to antimatter, there is a great deal of energy released. If one could harness that into a propulsion system, that would be great. But we don't have the capability to do that.

President: Do we have one of their spaceships?

Caretaker: Yes, well, partially. A crashed one.

President: OK, can we or do we have the technical knowledge to understand it?

Casey: No, Mr. President, we don't.

President: We can make atomic bombs, go to Mars, and we can't understand their science?

Casey: Adviser #4?

Adviser #4: Mr. President, their technology is probably 1,000 years more advanced than ours . . . maybe even more. They have different materials to work with. Some of their materials are not found on this planet.

President: What do you mean, like iron or elements?

Adviser #4: Yes, Mr. President. We found many metals and other things that are not found on this planet. Maybe they have more than 104 elements or maybe they are different than ours.

President: The hostile ones or the Ebens?

Adviser #4: Mr. President that goes for each species although the Ebens do have similar elements as [those found on] Earth. But the Trantaloids have strange materials . . . nothing like [those found on] Earth. These aliens can imitate humans. They can look like blond humans. However, they are not blond, but ugly-looking insects.

President: Insects, did you say that?

Adviser #4: Yes, do you have a photograph?

Caretaker: Yes, hold on.

Casey: They are pretty nasty looking.

President: Well, they would stand out.

Adviser #4: No, Mr. President, as I said they can imitate looking like humans.

President: How in the world do they do that? It took a lot of makeup to make me look good in the movies. [loud laughter heard]

Adviser #4: Well, Mr. President, I can assure you they don't use makeup, at least not like we would. They have the ability to change their bodies. As I said before, they are 1,000 years ahead of us in technology and probably every other science.

President: They can be killed?

Adviser #4: Yes, they are just flesh and blood, like a human body. They can be killed. But their spaceships have a force field around them. They can be shot down, but it takes some doing on our part.

Casey: Mr. President, we have to use a small-style nuclear missile to shoot them down, but we haven't actually done that yet. We have experimented in Nevada on the captured craft we have of theirs.

President: My God, I hope we haven't used atomic missiles. What does that mean?! I have to give that order!

Adviser #1: Excuse me, but Mr. President, no, we haven't used any nuclear missiles to shoot down any alien flying craft. I think Adviser #4 and the Director mean that if we had to shoot one down, for instance if a group of them attacked us.

President: Is that likely?

Adviser #1: No, I don't think so.

President: Can we intercept their radio transmissions? Do we know their language?

Adviser #1: We know or we can recognize their language, which is entirely different than the Ebens. They use a very high-band radio system. But they have different frequencies, and it is difficult for NSA to track them.

President: Maybe we should call Captain Kirk?! [loud laughter] Oh, a little humor is good in any situation! [loud laughter]

Adviser #1: OK, Mr. President, I'll call Scotty! [more laughter]

President: Yeah, maybe [Gene] Roddenberry knows.!

Adviser #1: Our air defenses are as best prepared as we can be against any form of an attack by this group.

President: How do we do that? I mean, our pilots. Do they know?

Adviser #1: Not exactly. But we have a system to cover any threat.

President: A war plan?

Adviser #1: Like I said earlier, yes, Mr. President, we do have war plans just for this event or possible event.

President: OK. Well, I think that is enough for one day. Bill, set something up for tomorrow to finish this.

Casey: OK, Mr. President. I'll get with Adviser #2 and Michael [Deaver].

President: I want to thank everyone for a very thorough briefing. I was educated beyond belief. I will have a different attitude every time I look up in the sky.

[TAPE ENDS]

CAM: If the Reagan briefing wasn't genuine, it would be more polished. This is a natural interchange, which is what you would expect from a normal, conversational-style briefing, especially for a president who can interrupt any time he likes—which President Reagan did here on numerous occasions. I have every confidence that the "Reagan briefing" is genuine.

ENDNOTES

1. Why would Project Aquarius even exist if there wasn't something to all this? It's because there is something to all this, and there has been all along.

[reaganlibrary.gov/public/2021-06/40-654-209237722-045-010-2021.pdf, pages 14-16]

TOP SECRET

PROJECT AQUARIUS

(TS/ORCON) (PROWORD): XXXXXX Contains 16 volumes of documented information collected from the beginning of the United States' Investigation of Unidentified Flying Objects (UFOs) and Identified Alien Crafts (IAC). The Project was originally established in 1953, by order of President Eisenhower, under control of XXXX and MJ12. In 1960, the Project's name was changed from Project XXXX to Project Aquarius. The Project was funded by XXX confidential funds (non-appropriated). The Project XXXX(for 1 full line)XXX Dec 1969 after Project Blue Book was closed. The purpose of Project Aquarius was to collect all scientific, technological, medical and intelligence information from UFO/IAC sightings and contacts with alien life forms. This orderly file of collected information has been used to advance the United States' Space Program.

(TS/ORCON) The preceding briefing is an historical account of the United States Government's investigation of Aerial Phenomenas, Recovered Alien Aircraft⁶, and contacts with extra-terrestrial Life Forms.

This page has no content.

Alien Photos



This section submits photos of aliens that have been presented as authentic. You will need to decide for yourselves. I included only those that I felt had considerable merit to be real. There are some very convincing sculptures and casts of aliens that are on the internet. I spent considerable time evaluating this material. If I have erred and have included any fabrications in my paper, then so be it (CAM).

ALIEN PHOTOS

In his book *Alien Agendas* Richard Dolan treats 37 species that are said to have visited Earth or to be here now. Visit richarddolanmembers.com for more information.



Two short grays.

These two individuals are part of the group commonly described as short grays. They have 4 fingers with opposable thumbs as well. The skin tight uniform of the one individual shows ribs and collarbones like ours. The one thing I wonder about is the structure just coming off where the arm attaches. Is this a robust rib that might aid in strengthening the shoulder? Or could it be a forward facing shoulder blade? If it is either, then that would be unique.



A US military officer shaking hands with an ET.

If this is indeed a U.S. Military officer then he is in a uniform that I am not familiar with. I assume that this particular branch would have their own uniforms. Note in the case of this species of being, that he has an opposable thumb. It is tall and slender, much the same as the tall greys are described.



Alien in a space suit.

This individual has that basic shape of the tall gray. His ship in the background looks like it could be of the Tic-Tac variety.

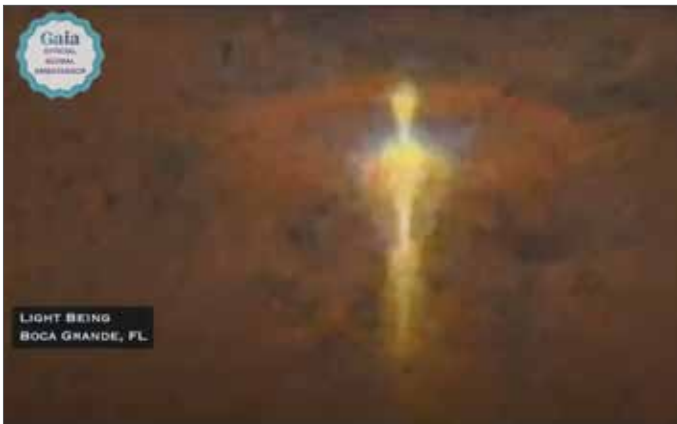

Being of light.

This is a light being with a somewhat human shape. This photo comes from a CE5 event in Boca Grande, Florida. I favor this photo as being genuine because I have come to a personal conclusion and belief that humans are spirit beings who have been placed in human bodies in order to learn and grow. Since I believe that we are spirit beings, I find it reasonable that there are species that have evolved to this level and are making themselves known.



Above and below: This species appears to be very close to *Moltonus dolani* in size and shape. However, I am of the opinion that it is different because it appears to have more forward facing eyes, stronger nose, and somewhat different rib cage. Also, from what I can tell, the two species have different skin patterns. This species appears to me more smooth skinned.



This species appears small. They have forward facing eyes, a small nose, and only the hint of an ear. No visible collar bones.





Above and below: This species also appears to be of the tall grays type. They have three toes like Maria but their feet are much more like ours.

In the UFO stories that are out there, there is talk about 6 crash victims that were recovered. It is reasonable to assume that these are they.

I think it is possible to date the photo based on the design of the gurneys. I would try and date the wheels first.

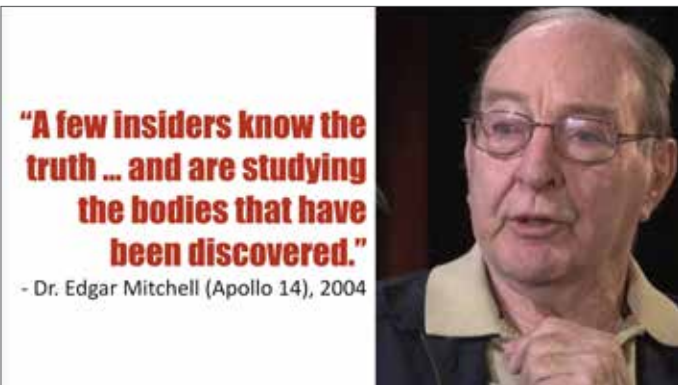

The best for last.

These are screenshots from film uploaded to YouTube in 2011 by ivan0135. It is a suite of four black and white clips from either 8mm or 16mm film. The footage is reported to be from events that happened between 1942 and 1969. Since the film was uploaded, ivan0135 has never come forward to make any kind of claim that it is different than what it appears to be.

One of the four clips is of this tall gray (EBEN) alien from Zeta Reticuli who is reported to be working with the United States government (nicknamed Skinny Bob). The way the film was shot indicates it was made to document this individual, who seems to be aware of the camera. At the end there is a brief glimpse of other individuals.

While you watch the film notice how fluidly he moves. I was also taken by the way he blinks. It was how he blinks that convinced me that it is very likely genuine. The eyelid is unique.

“OBJECTS UNKNOWN - The Skinny Bob Mystery”
[youtube.com/watch?v=hRCO9GAX3Sg](https://www.youtube.com/watch?v=hRCO9GAX3Sg)

In conclusion there are more than enough pieces of this puzzle that fit together to make it reality. The evidence is overwhelming. The vast majority of it has happened. All we need to do now is tear down the wall of secrecy set up by those in the US government who are keeping this secret.



Estimate of the Situation

My number one goal with this paper is to give everyone who reads it calibrated eyes. By reading this paper you are in the process of “learning to see.” This is a phrase that I used while my company, Western Paleontological Laboratories Inc., collaborated with Thanksgiving Point management to build the North American Museum of Ancient Life in Lehi, Utah.

I recognize that the vast majority of those who read *The Miles Paper* had no clue that any of this material ever existed. Now we will all be on a better footing to get the truth out in the open. We need to stop living in a world of illusion and fiction, **which** is where we currently are **with** this topic.

Alien races are here now. We are here at their discretion. Tall grays, short grays, and nordics, at the very least, watch over us to see that we are not interfered with. We are an investment in the universe for them. They want us to succeed. They want to ensure that we do not blow ourselves up. They have the ability to turn off our nuclear warheads any time they like, so they must have a contingency of ships on standby in order to perform this duty if necessary.

The Rendlesham Forest and Wadley, Georgia, incidents need to be taken seriously. We need to uncover what has been hidden from us by the forces that insist this stay secret. Hopefully this paper will be the catalyst for increased disclosure.

There is no longer a need for continued investment in nuclear weapons, unless the United States Space Force knows otherwise. We are shooting at some of these alien crafts. You can see it in the video

I have linked. Why is that? Do we and one of the alien races have a common enemy?

ET beings have the ability to interfere with our fighter jets any time they like. They did this with an Iranian fighter jet in 1976 that was about to fire on the craft. The craft detected the fighter jet’s intent and disabled its electronics. This clearly demonstrates superior ability. Military jets are obsolete.

A certain percentage of the craft that are flying are ours. I am certain of this. Ben Rich of Lockheed said so. The TR3B is one such craft. How many are there? How long does it take to build them? Two a year puts the number over a 100. Richard Dolan recently did a thought experiment and came up with the number 350. I agree with his reasoning. This number is for all alien-like craft, ours as well as theirs.

We already have bases on both the moon and Mars, if you believe what others are saying—which I do. And by extension, we are also involved in resource exchange.

Worm holes, warp speed, and space folding exist. They are concepts that were given to us through the knowing field. We are first made aware of them in our television and movies, and once they become part of our realm of possibility, we tease them into existence through our scientists.

ADDITIONAL THOUGHTS

There are some things that cannot be proven with the scientific method. Because it cannot be proven, that is no reason to ignore it.

Un-decide-ability is the state of being neither provable nor refutable in a specified deductive system. There will always be true statements that cannot be proven. But once you get consistency in people's statements then you cannot ignore what they are telling you. The more similar or the same these statements build up in numbers, then statistically what is being said must be favored as truth.

Consistency = Truth

I believe that there is a "thought force" that acts upon the universe. Consciousness must be an integral part of the world we observe.

There are many wonderful majestic activities and processes behind the veil that has been placed on us here on Earth. It is all interconnected, and we need to find out about all that interconnectedness. Hopefully we can work to tease it out from obscurity so that we may enjoy its gifts.

Once the alien races that are here make themselves known to the general population, we will be better enlightened about the above.

Is something observing the universe into existence? If it is, then it is the source (God). So if God is observing us into existence, are we in a simulation? If we are in a simulation, that might explain how traveling at the speed of thought is possible or probable.

Some people have **epistemic** access to information that others don't (having a knowledge of things

that you would not think possible). I have personally experienced this. My best friend Brian was late arriving for work. While I waited for him to arrive I asked myself, "I wonder where Brian is?" The spirit passed through me two words, "He's dead!" A short time later this was proven to be true. He had been killed in a car accident while coming to work. I have had many of these kinds of experiences, and they have been written about in my book *Does God Bite*, which I am still working on. I have made 4 parts of it available on my website TheMilesPaper.com.

Mind is built into the universe, and I believe this is how the thought force exists. The thought force exists along with the strong force, weak force, and gravity. So, are we being blinded in some way regarding our physics? The universe is mentally connected, so how does this play into our physics? We need to consider the possibility of how the thought force exists. If you have never experienced it, then it is likely going to be very difficult for you to accept its existence. Those who have experienced it, know its value.

You can become connected to the thought force or stay disconnected, it's totally up to you.

I look forward to exploring this more with you in the future.

All for now,

Cliff Miles

This page has no content.